

NUS3116MT

Main Switch Power MOSFET and Dual Charging BJT

-12 V, -6.2 A, μ COOL™ Single P-Channel with Dual PNP low $V_{ce(sat)}$ Transistors, 3x3 mm WDFN Package

This device integrates one high performance power MOSFET and two low $V_{ce(sat)}$ transistors, greatly reducing the layout space and optimizing charging performance in the battery-powered portable electronics.

Features

- High Performance Power MOSFET
- Dual-Low $V_{ce(sat)}$ Transistors as Charging Power Mux
- 3.0x3.0x0.8 mm WDFN Package
- Independent Pin-out Provides Circuit Flexibility
- Low Profile (<0.8 mm) for Easy Fit in Thin Environments
- This is a Pb-Free Device

Applications

- Main Switch and Battery Charging Mux for Portable Electronics
- Optimized for Commercial PMUs from Top Suppliers (See Figure 2)

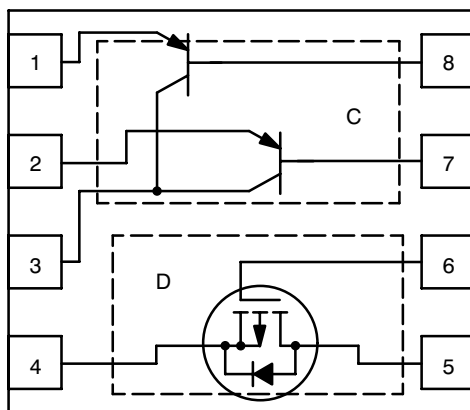

μ COOL™ 3x3 Pin Connections (Top View)

Figure 1. Simple Schematic



ON Semiconductor®

<http://onsemi.com>

MOSFET

$V_{(BR)DSS}$	$R_{DS(on)}$ TYP	I_D MAX
-12 V	32 m Ω @ -4.5 V	-6.2 A
	44 m Ω @ -2.5 V	

Low $V_{ce(sat)}$ PNP (Wall)

V_{CE0} MAX	V_{EBO} MAX	I_C MAX
-30 V	-8.0 V	-2.0 A

Low $V_{ce(sat)}$ PNP (USB)

V_{CE0} MAX	V_{EBO} MAX	I_C MAX
-30 V	-8.0 V	-2.0 A



DFN8
CASE 506BC

MARKING DIAGRAM

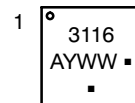

3116 = Device Code
 A = Assembly Location
 Y = Year
 WW = Work Week
 ■ = Pb-Free Package

(Note: Microdot may be in either location)

ORDERING INFORMATION

Device	Package	Shipping†
NUS3116MTR2G	WDFN8 (Pb-Free)	3000/Tape & Reel

†For information on tape and reel specifications, including part orientation and tape sizes, please refer to our Tape and Reel Packaging Specification Brochure, BRD8011/D.

NUS3116MT

P-Channel Power MOSFET Maximum Ratings ($T_J = 25^\circ\text{C}$ unless otherwise stated)

Parameter		Symbol	Value	Units	
Drain-to-Source Voltage		V_{DS}	-12	V	
Gate-to-Source Voltage		V_{GS}	± 8.0	V	
Continuous Drain Current (Note 1)	Steady State	$T_A = 25^\circ\text{C}$	-5.47	A	
		$T_A = 85^\circ\text{C}$	-4.0		
	$t \leq 5 \text{ s}$	$T_A = 25^\circ\text{C}$	-6.2		
Power Dissipation (Note 1)	Steady State	$T_A = 25^\circ\text{C}$	1.7	W	
	$t \leq 5 \text{ s}$		2.2		
Continuous Drain Current (Note 2, Minimum Pad)	Steady State	$T_A = 25^\circ\text{C}$	-4.4	A	
		$T_A = 85^\circ\text{C}$	-3.2		
	Power Dissipation (Note 2)	$T_A = 25^\circ\text{C}$	P_D	1.14	W
Pulsed Drain Current	$t_p = 10 \mu\text{s}$		I_{DM}	-25	A
Operating Junction and Storage Temperature		T_J, T_{STG}	-55 to 150	$^\circ\text{C}$	
Source Current (Body Diode) ²		I_S	-2.8	A	
Lead Temperature for Soldering Purposes (1/8" from case for 10 s)		T_L	260	$^\circ\text{C}$	

THERMAL RESISTANCE RATINGS

Parameter	Symbol	Max	Units
Junction-to-Ambient – Steady State (Note 2)	$R_{\theta JA}$	110	$^\circ\text{C/W}$
Junction-to-Ambient – $t < 10 \text{ s}$ (Note 2)	$R_{\theta JA}$	56	$^\circ\text{C/W}$
Junction-to-Ambient – Steady State (Note 1)	$R_{\theta JA}$	72	$^\circ\text{C/W}$
Junction-to-Ambient – $t < 10 \text{ s}$ (Note 1)	$R_{\theta JA}$	40	$^\circ\text{C/W}$

Stresses exceeding Maximum Ratings may damage the device. Maximum Ratings are stress ratings only. Functional operation above the Recommended Operating Conditions is not implied. Extended exposure to stresses above the Recommended Operating Conditions may affect device reliability.

- Surface-mounted on FR4 board using 1 in sq pad size (Cu area = 1.127 in sq [1 oz] including traces)
- Surface-mounted on FR4 board using the minimum recommended pad size of 0.5 in sq, 1 oz. Cu.

P-Channel MOSFET Electrical Characteristics ($T_J = 25^\circ\text{C}$ unless otherwise specified)

Parameter	Symbol	Test Condition	Min	Typ	Max	Units
-----------	--------	----------------	-----	-----	-----	-------

OFF CHARACTERISTICS

Drain-to-Source Breakdown Voltage	$V_{(BR)DSS}$	$V_{GS} = 0 \text{ V}, I_D = -250 \mu\text{A}$	-12.0			V
Drain-to-Source Breakdown Voltage Temperature Coefficient	$V_{(BR)DSS}/T_J$	$I_D = -250 \mu\text{A}, \text{ref to } 25^\circ\text{C}$		-10.1		$\text{mV}/^\circ\text{C}$
Zero Gate Voltage Drain Current	I_{DSS}	$V_{GS} = 0 \text{ V}, V_{DS} = -12 \text{ V}$	$T_J = 25^\circ\text{C}$		-1.0	μA
			$T_J = 125^\circ\text{C}$		-10	
Gate-to-Source Leakage Current	I_{GSS}	$V_{DS} = 0 \text{ V}, V_{GS} = \pm 8 \text{ V}$			± 200	nA

ON CHARACTERISTICS (Note 3)

Gate Threshold Voltage	$V_{GS(TH)}$	$V_{GS} = V_{DS}, I_D = -250 \mu\text{A}$	-0.45	-0.67	-1.1	V
Negative Threshold Temperature Coefficient	$V_{GS(TH)}/T_J$			2.68		$\text{mV}/^\circ\text{C}$
Drain-to-Source On Resistance	$R_{DS(on)}$	$V_{GS} = -4.5 \text{ V}, I_D = -3.0 \text{ A}$		32	40	$\text{m}\Omega$
		$V_{GS} = -2.5 \text{ V}, I_D = -3.0 \text{ A}$		44	50	
Forward Transconductance	g_{FS}	$V_{DS} = -16 \text{ V}, I_D = -3.0 \text{ A}$		5.9		S

- Pulsed Condition: Pulse Width = 300 μsec , Duty Cycle $\leq 2\%$

NUS3116MT

P-Channel MOSFET Electrical Characteristics (T_J = 25°C unless otherwise specified)

Parameter	Symbol	Test Condition	Min	Typ	Max	Units
-----------	--------	----------------	-----	-----	-----	-------

CHARGES, CAPACITANCES AND GATE RESISTANCE

Input Capacitance	C _{ISS}	V _{GS} = 0 V, f = 1.0 MHz, V _{DS} = -12 V		1329		pF
Output Capacitance	C _{OSS}			200		
Reverse Transfer Capacitance	C _{RSS}			116		
Total Gate Charge	Q _{G(tot)}	V _{GS} = -4.5 V, V _{DS} = -12 V, I _D = -3.0 A		13		nC
Threshold Gate Charge	Q _{G(th)}			1.5		
Gate-to-Source Charge	Q _{GS}			2.2		
Gate-to-Drain Charge	Q _{GD}			2.9		

SWITCHING CHARACTERISTICS

Turn-On Delay Time	t _{d(on)}	V _{GS} = -4.5 V, V _{DD} = -12 V, I _D = -3.0 A, R _G = 3.0		8		ns
Rise Time	t _r			17.5		
Turn-Off Delay Time	t _{d(off)}			80		
Fall Time	t _f			56.5		

DRAIN-SOURCE DIODE CHARACTERISTICS

Forward Recovery Voltage	V _{SD}	V _{GS} = 0 V, I _S = -1.0 A	T _J = 25°C		-0.66	-1.2	V
			T _J = 125°C		-0.54		
Reverse Recovery Time	t _{rr}	V _{GS} = 0 V, dI _{SD} /dt = 100 A/μs, I _S = -1.0 A		70.8		ns	
Charge Time	t _a			14.3			
Discharge Time	t _b			56.4			
Reverse Recovery Charge	Q _{RR}			44		nC	

3. Pulsed Condition: Pulse Width = 300 μsec, Duty Cycle ≤ 2%

Dual-PNP Transistors Maximum Ratings (T_J = 25°C unless otherwise stated)

Parameter	Symbol	Value	Units
Collector-Emitter Voltage	V _{CEO}	-30	V
Collector-Base Voltage	V _{CBO}	-30	V
Emitter-Base Voltage	V _{EBO}	-8.0	V
Collector Current, Continuous	I _C	-2.0	A
Collector Current, Pulsed (Note 4)	I _C	-6.0	A
Operating Junction and Storage Temperature	T _J , T _{STG}	-55 to 150	°C
Thermal Resistance Dissipation	P _D	1.5	W
Thermal Resistance (Note 5)	R _{θJA}	83	°C/W
Thermal Resistance Dissipation	P _D	810	mW
Thermal Resistance (Note 6)	R _{θJA}	155	°C/W

4. Single Pulse: Pulse Width = 1 ms

5. Surface-mounted on FR4 board using 1 in sq pad size (Cu area = 1.127 in sq [1 oz] including traces)

6. Surface-mounted on FR4 board using the minimum recommended pad size of 100 mm², 1 oz. Cu.

NUS3116MT

Dual-PNP Transistors Electrical Characteristics ($T_J = 25^\circ\text{C}$ unless otherwise stated)

Parameter	Symbol	Test Condition	Min	Typ	Max	Units
-----------	--------	----------------	-----	-----	-----	-------

OFF CHARACTERISTICS

Collector-Emitter Voltage	V_{CE0}	$I_C = -10\text{ mA}, I_B = 0$	-30			V
Collector-Base Voltage	V_{CBO}	$I_C = -0.1\text{ mA}, I_E = 0$	-30			V
Emitter-Base Voltage	V_{EBO}	$I_E = -0.1\text{ mA}, I_C = 0$	-8.0			V
Collector-Emitter Cutoff Current	I_{CES}	$V_{CES} = -30\text{ V}$			-0.1	μA

ON CHARACTERISTICS

DC Current Gain (Note 7)	h_{FE}	$I_C = -1.0\text{ A}, V_{CE} = -2.0\text{ V}$	100	200		-
DC Current Gain (Note 7)	h_{FE}	$I_C = -2.0\text{ A}, V_{CE} = -2.0\text{ V}$	100	200		-
Collector-Emitter Saturation Voltage	$V_{CE(sat)}$	$I_C = -1.0\text{ A}, I_B = -0.01\text{ A}$			0.22	V
Collector-Emitter Saturation Voltage	$V_{CE(sat)}$	$I_C = -1.0\text{ A}, I_B = -0.1\text{ A}$			0.12	V
Collector-Emitter Saturation Voltage	$V_{CE(sat)}$	$I_C = -2.0\text{ A}, I_B = -0.2\text{ A}$			0.24	V
Input Capacitance	C_{ibo}	$V_{EB} = -0.5\text{ V}, f = 1.0\text{ MHz}$		240	400	pF
Output Capacitance	C_{obo}	$V_{CB} = -3.0\text{ V}, f = 1.0\text{ MHz}$		50	100	pF

7. Pulsed Condition: Pulse Width = 300 μsec , Duty Cycle $\leq 2\%$

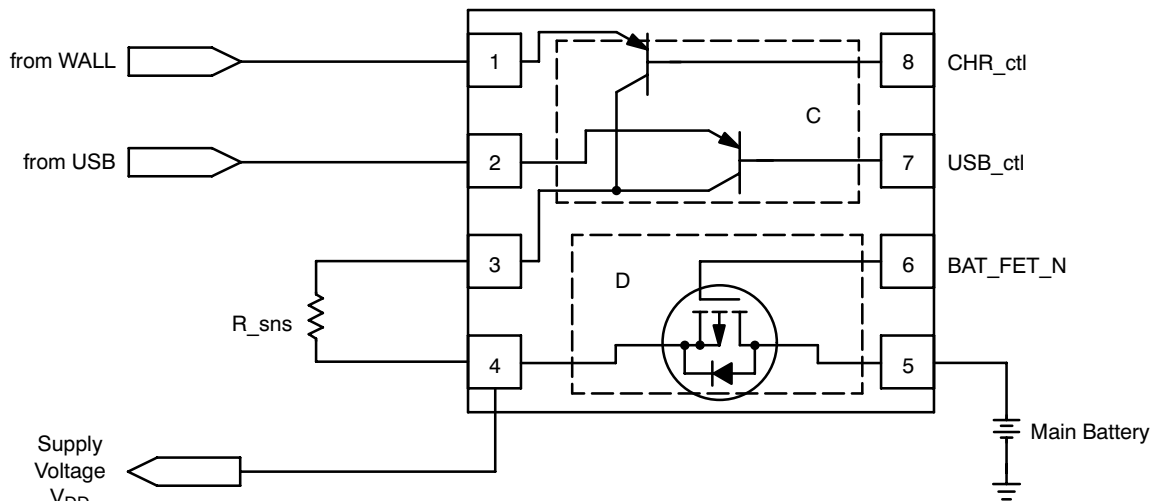

Figure 2. Typical Application Circuit

TYPICAL CHARACTERISTICS - MOSFET

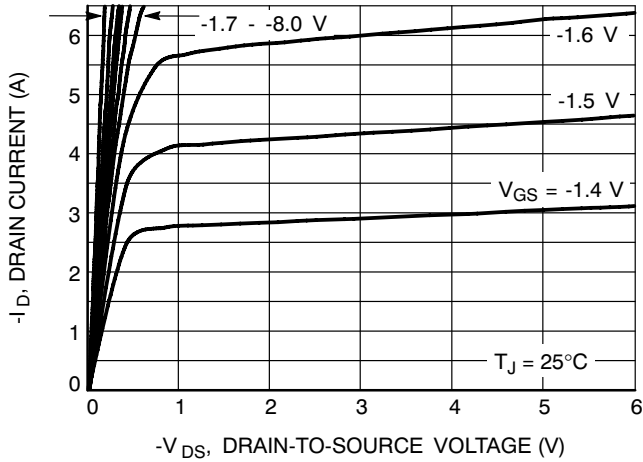

Figure 3. On-Region Characteristics

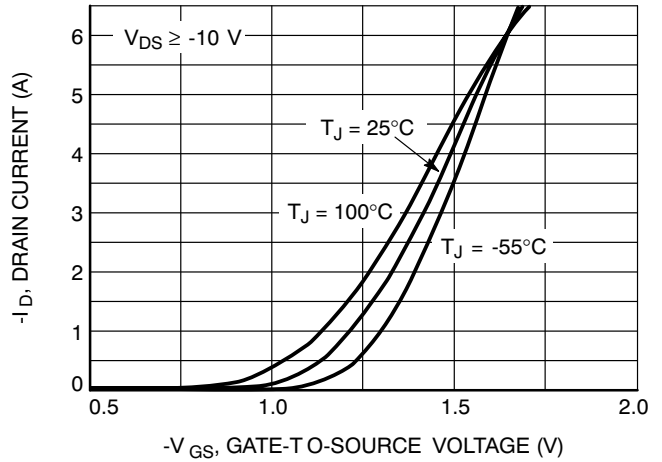

Figure 4. Transfer Characteristics

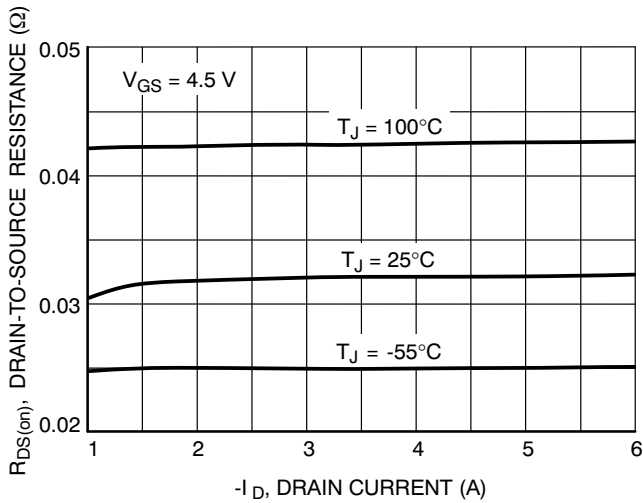

Figure 5. On-Resistance vs. Drain Current

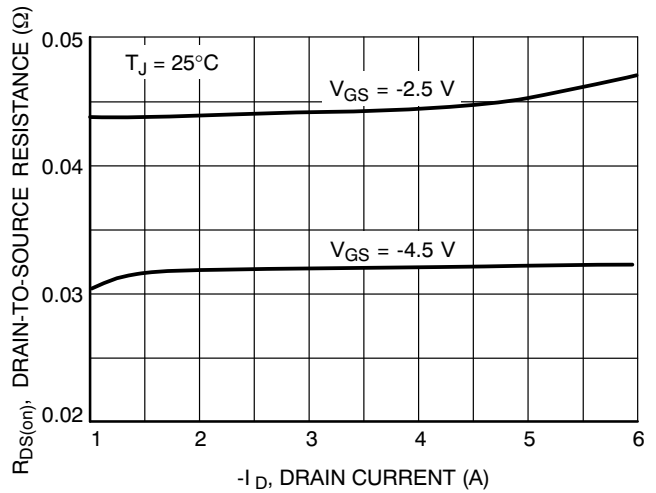

Figure 6. On-Resistance vs. Drain Current and Gate Voltage

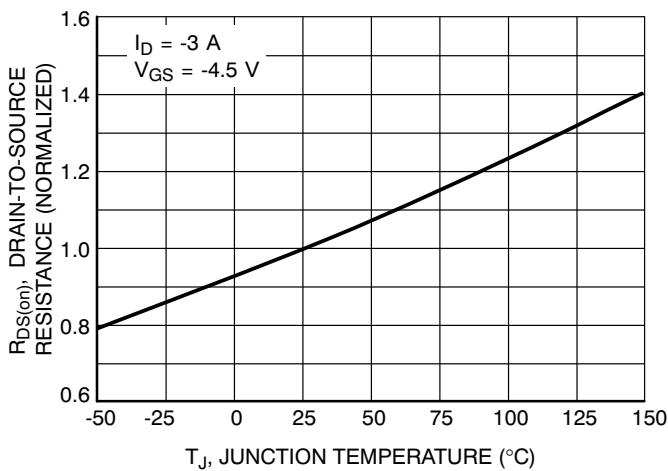

Figure 7. On-Resistance Variation with Temperature

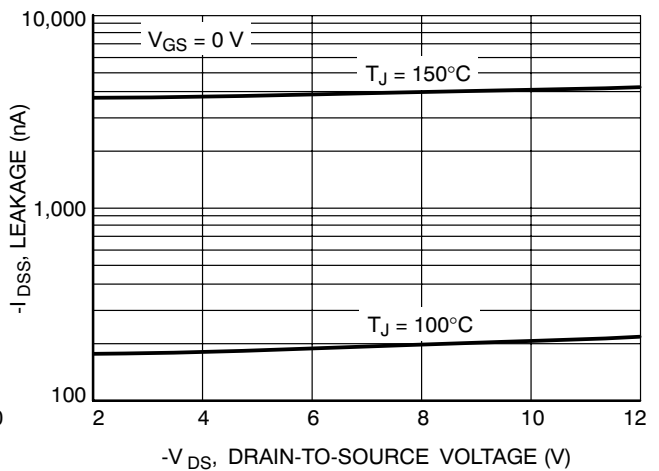

Figure 8. Drain-to-Source Leakage Current vs. Voltage

TYPICAL CHARACTERISTICS - MOSFET

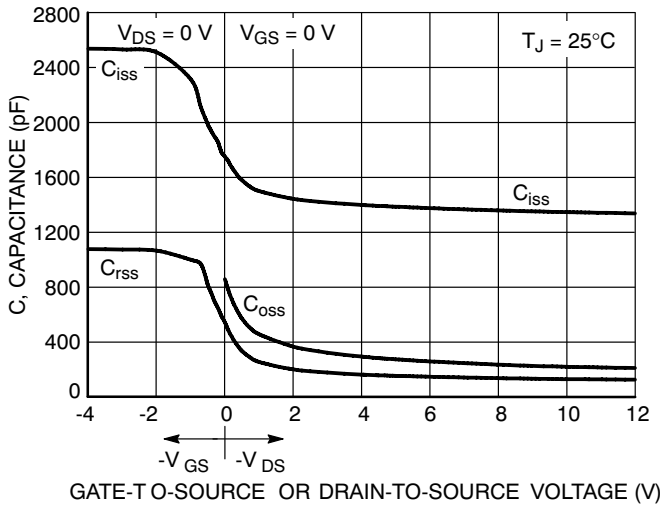

Figure 9. Capacitance Variation

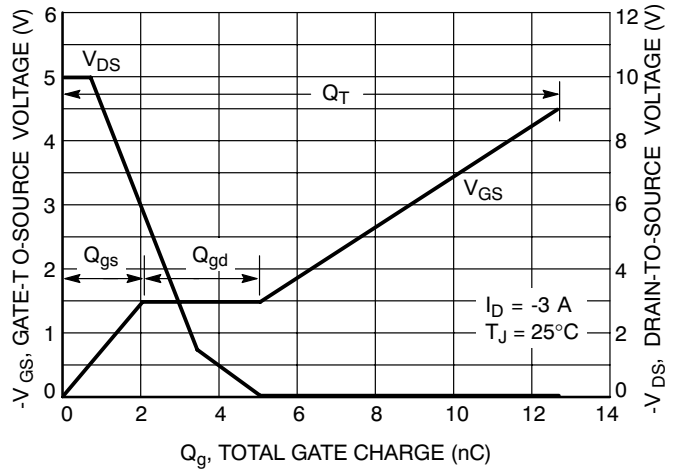

Figure 10. Gate-to-Source and Drain-to-Source Voltage vs. Total Charge

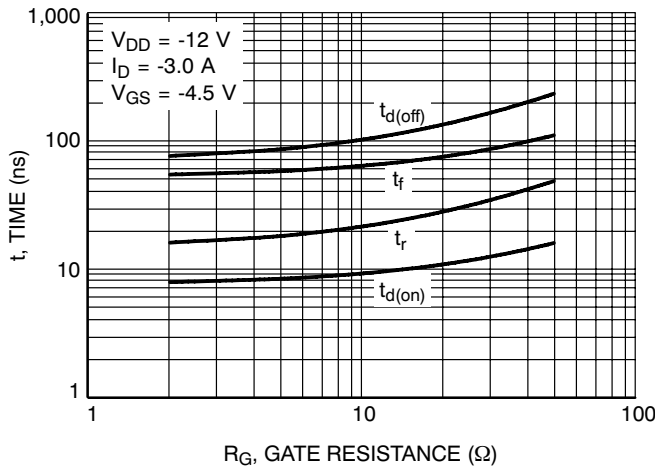

Figure 11. Resistive Switching Time Variation vs. Gate Resistance

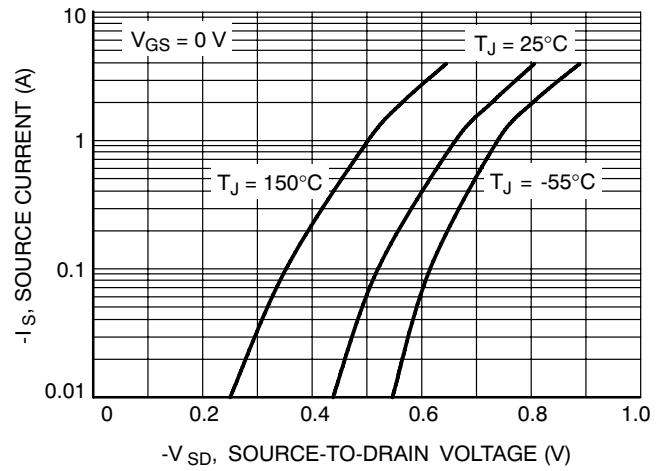
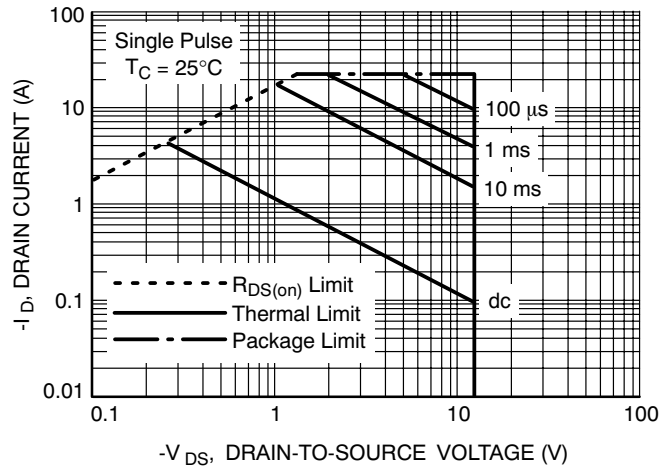

Figure 12. Diode Forward Voltage vs. Current



Mounted on 2" sq. FR4 board (0.5" sq. 2 oz. Cu single sided) with MOSFET die operating.

Figure 13. Maximum Rated Forward Biased Safe Operating Area

NUS3116MT

TYPICAL CHARACTERISTICS - MOSFET

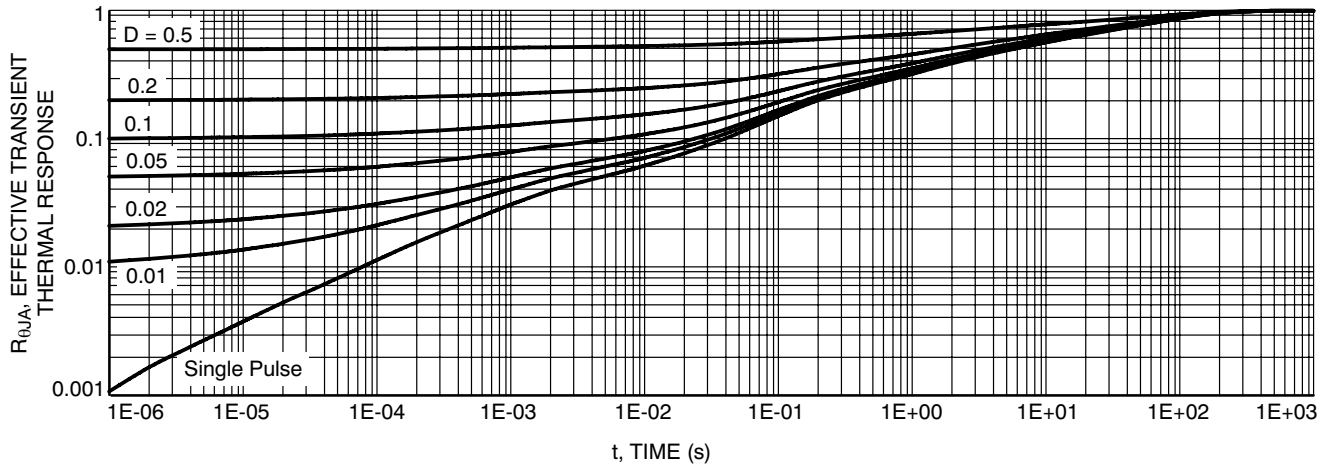

Figure 14. FET Thermal Response

TYPICAL CHARACTERISTICS - BJT

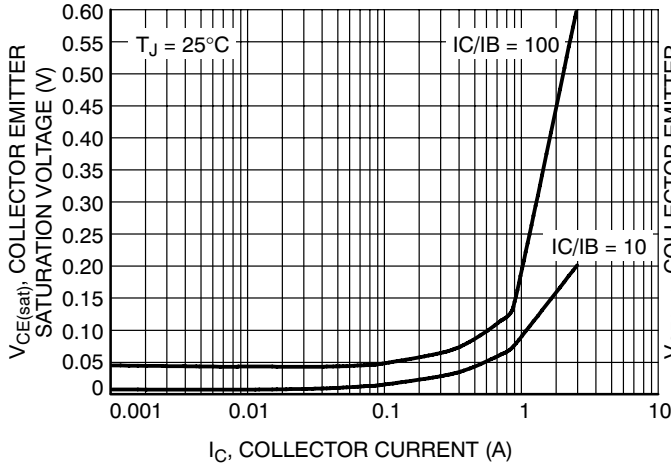

Figure 15. Collector Emitter Saturation Voltage vs. Collector Current

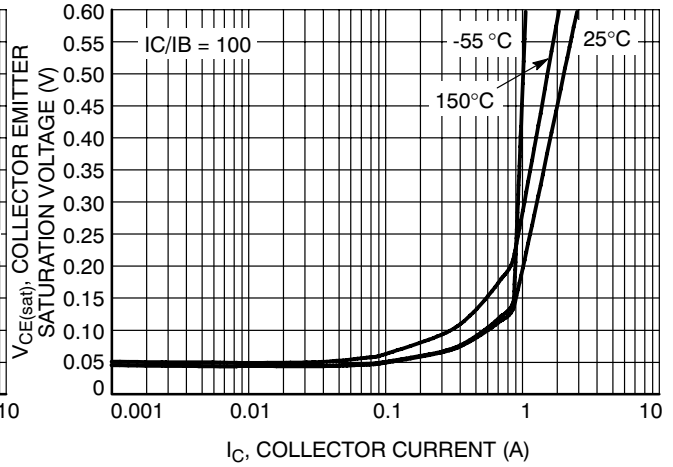

Figure 16. Collector Emitter Saturation Voltage vs. Collector Current

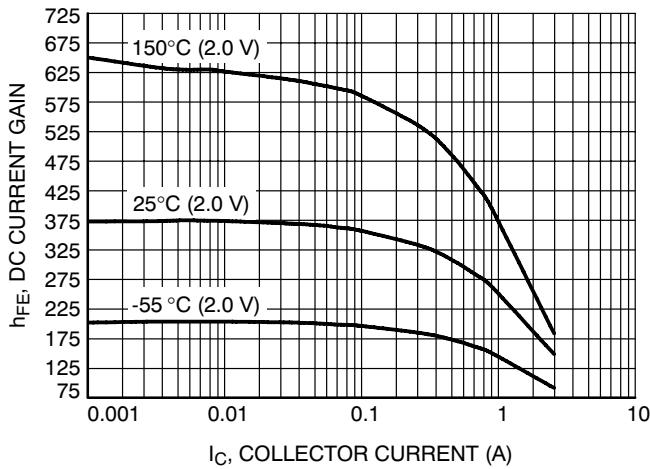

Figure 17. DC Current Gain vs. Collector Current

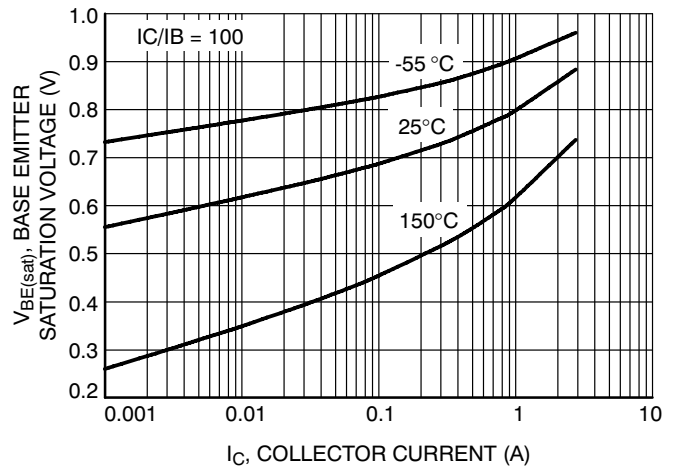

Figure 18. Base Emitter Saturation Voltage vs. Collector Current

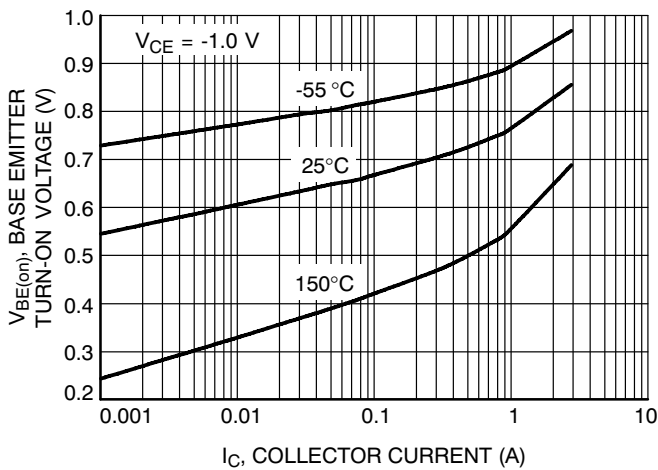

Figure 19. Base Emitter Turn-On Voltage vs. Collector Current

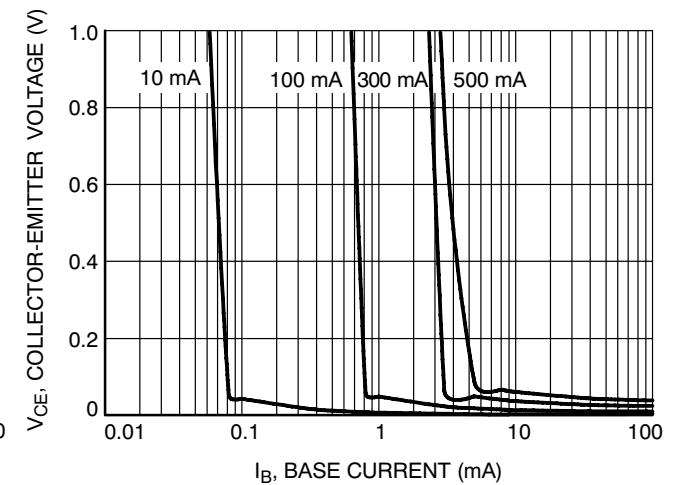

Figure 20. Saturation Region

NUS3116MT

TYPICAL CHARACTERISTICS - BJT

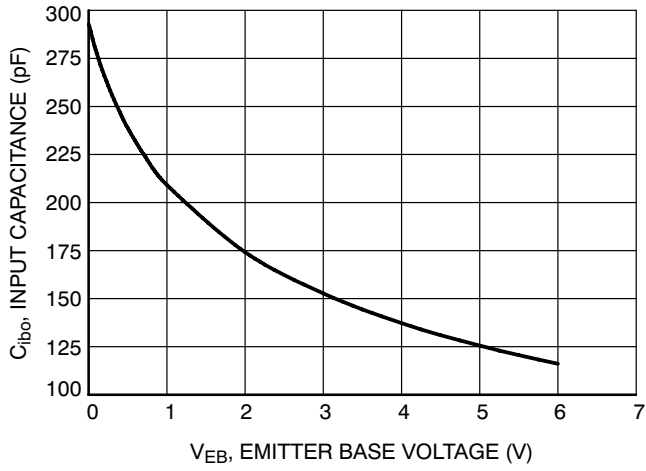

Figure 21. Input Capacitance

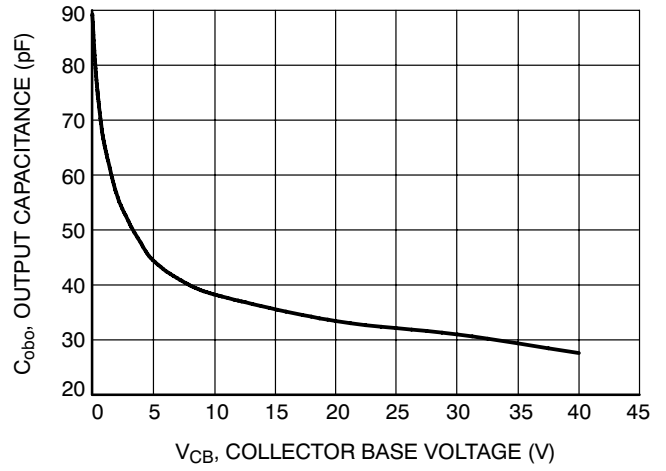
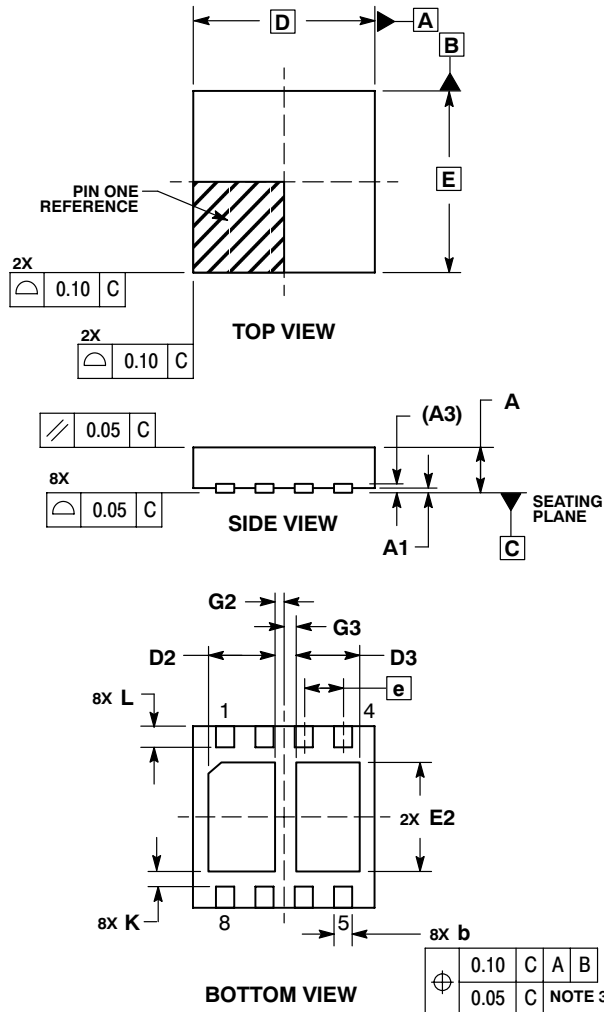

Figure 22. Output Capacitance

NUS3116MT

PACKAGE DIMENSIONS

DFN8, 3x3, 0.65P
CASE 506BC-01
ISSUE O



NOTES:

1. DIMENSIONING AND TOLERANCING PER ASME Y14.5M, 1994.
2. CONTROLLING DIMENSION: MILLIMETERS.
3. DIMENSION b APPLIES TO PLATED TERMINAL AND IS MEASURED BETWEEN 0.15 AND 0.30mm.
4. COPLANARITY APPLIES TO THE EXPOSED PAD AS WELL AS THE TERMINALS.

MILLIMETERS		
DIM	MIN	MAX
A	0.70	0.80
A1	0.00	0.05
A3	0.20 REF	
b	0.25	0.35
D	3.00 BSC	
D2	1.00	1.20
D3	0.95	1.15
E	3.00 BSC	
E2	1.70	1.90
e	0.65 BSC	
G2	0.15 REF	
G3	0.20 REF	
K	0.20	---
L	0.25	0.45

STYLE 1:

- PIN 1. EMITTER1
2. EMITTER2
3. COLLECTOR
4. SOURCE
5. DRAIN
6. GATE
7. BASE2
8. BASE1

SOLDERING FOOTPRINT*

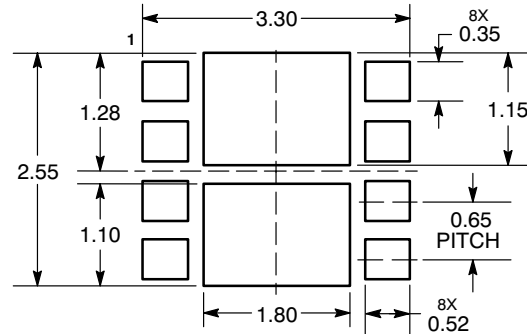

DIMENSIONS: MILLIMETERS

*For additional information on our Pb-Free strategy and soldering details, please download the ON Semiconductor Soldering and Mounting Techniques Reference Manual, SOLDERRM/D.

ON Semiconductor and are registered trademarks of Semiconductor Components Industries, LLC (SCILLC). SCILLC reserves the right to make changes without further notice to any products herein. SCILLC makes no warranty, representation or guarantee regarding the suitability of its products for any particular purpose, nor does SCILLC assume any liability arising out of the application or use of any product or circuit, and specifically disclaims any and all liability, including without limitation special, consequential or incidental damages. "Typical" parameters which may be provided in SCILLC data sheets and/or specifications can and do vary in different applications and actual performance may vary over time. All operating parameters, including "Typicals" must be validated for each customer application by customer's technical experts. SCILLC does not convey any license under its patent rights nor the rights of others. SCILLC products are not designed, intended, or authorized for use as components in systems intended for surgical implant into the body, or other applications intended to support or sustain life, or for any other application in which the failure of the SCILLC product could create a situation where personal injury or death may occur. Should Buyer purchase or use SCILLC products for any such unintended or unauthorized application, Buyer shall indemnify and hold SCILLC and its officers, employees, subsidiaries, affiliates, and distributors harmless against all claims, costs, damages, and expenses, and reasonable attorney fees arising out of, directly or indirectly, any claim of personal injury or death associated with such unintended or unauthorized use, even if such claim alleges that SCILLC was negligent regarding the design or manufacture of the part. SCILLC is an Equal Opportunity/Affirmative Action Employer. This literature is subject to all applicable copyright laws and is not for resale in any manner.

PUBLICATION ORDERING INFORMATION

LITERATURE FULFILLMENT:

Literature Distribution Center for ON Semiconductor
P.O. Box 5163, Denver, Colorado 80217 USA
Phone: 303-675-2175 or 800-344-3860 Toll Free USA/Canada
Fax: 303-675-2176 or 800-344-3867 Toll Free USA/Canada
Email: orderlit@onsemi.com

N. American Technical Support: 800-282-9855 Toll Free
USA/Canada
Europe, Middle East and Africa Technical Support:
Phone: 421 33 790 2910
Japan Customer Focus Center
Phone: 81-3-5773-3850

ON Semiconductor Website: www.onsemi.com

Order Literature: <http://www.onsemi.com/orderlit>

For additional information, please contact your local Sales Representative

NUS3116MT/D