

# MBR30H80CT, MBRB30H80CT-1

## SWITCHMODE™ Power Rectifier 80 V, 30 A

### Features and Benefits

- Low Power Loss/High Efficiency
- High Surge Capacity
- 30 A Total (15 A Per Diode Leg)
- These are Pb-Free Devices

### Applications

- Power Supply – Output Rectification
- Power Management
- Instrumentation

### Mechanical Characteristics:

- Case: Epoxy, Molded
- Epoxy Meets UL 94 V-0 @ 0.125 in
- Weight: 1.9 Grams (Approximately)
- Finish: All External Surfaces Corrosion Resistant and Terminal Leads are Readily Solderable
- Lead Temperature for Soldering Purposes:  
260°C Max. for 10 Seconds
- ESD Rating: Human Body Model = 3B  
Machine Model = C

### MAXIMUM RATINGS

Please See the Table on the Following Page



ON Semiconductor®

<http://onsemi.com>

## SCHOTTKY BARRIER RECTIFIER 30 AMPERES 80 VOLTS

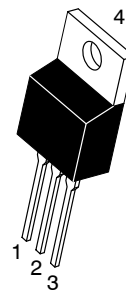
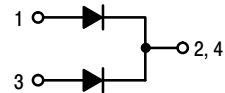

TO-220AB  
CASE 221A  
PLASTIC

### MARKING DIAGRAM

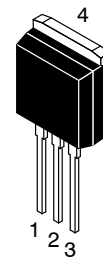
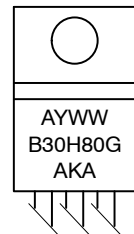

I²PAK (TO-262)  
CASE 418D  
PLASTIC  
STYLE 3

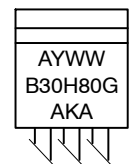

A = Assembly Location  
Y = Year  
WW = Work Week  
B30H80 = Device Code  
G = Pb-Free Package  
AKA = Polarity Designator

### ORDERING INFORMATION

See detailed ordering and shipping information in the package dimensions section on page 2 of this data sheet.

# MBR30H80CT, MBRB30H80CT-1

## MAXIMUM RATINGS (Per Diode Leg)

Rating	Symbol	Value	Unit
Peak Repetitive Reverse Voltage Working Peak Reverse Voltage DC Blocking Voltage	$V_{RRM}$ $V_{RWM}$ $V_R$	80	V
Average Rectified Forward Current ( $T_C = 130^\circ\text{C}$ ) Per Diode Per Device	$I_{F(AV)}$	15 30	A
Peak Repetitive Forward Current (Square Wave, 20 kHz, $T_C = 130^\circ\text{C}$ )	$I_{FM}$	30	A
Nonrepetitive Peak Surge Current (Surge applied at rated load conditions halfwave, single phase, 60 Hz)	$I_{FSM}$	240	A
Storage Temperature	$T_{stg}$	-65 to +175	$^\circ\text{C}$
Operating Junction Temperature (Note 1)	$T_J$	-20 to +150	$^\circ\text{C}$
ESD Ratings: Machine Model = C Human Body Model = 3B		> 400 > 8000	V

Stresses exceeding Maximum Ratings may damage the device. Maximum Ratings are stress ratings only. Functional operation above the Recommended Operating Conditions is not implied. Extended exposure to stresses above the Recommended Operating Conditions may affect device reliability.

1. The heat generated must be less than the thermal conductivity from Junction-to-Ambient:  $dP_D/dT_J < 1/R_{\theta JA}$ .

## THERMAL CHARACTERISTICS

Characteristic	Symbol	Value	Unit
Maximum Thermal Resistance - Junction-to-Case - Junction-to-Ambient	$R_{\theta JC}$ $R_{\theta JA}$	2.0 70	$^\circ\text{C}/\text{W}$

## ELECTRICAL CHARACTERISTICS (Per Diode Leg)

Characteristic	Symbol	Min	Typ	Max	Unit
Maximum Instantaneous Forward Voltage (Note 2) ( $i_F = 3\text{ A}$ , $T_J = 25^\circ\text{C}$ ) ( $i_F = 3\text{ A}$ , $T_J = 25^\circ\text{C}$ ) ( $i_F = 15\text{ A}$ , $T_J = 25^\circ\text{C}$ ) ( $i_F = 15\text{ A}$ , $T_J = 125^\circ\text{C}$ ) ( $i_F = 30\text{ A}$ , $T_J = 25^\circ\text{C}$ ) ( $i_F = 30\text{ A}$ , $T_J = 125^\circ\text{C}$ )	$V_F$	-	0.49 0.37 0.65 0.55 0.77 0.67	0.58 0.45 0.78 0.65 0.88 0.75	V
Maximum Instantaneous Reverse Current (Note 2) (Rated DC Voltage, $T_J = 125^\circ\text{C}$ ) (Rated DC Voltage, $T_J = 25^\circ\text{C}$ )	$i_R$	-	12 0.017	35 0.250	mA

2. Pulse Test: Pulse Width = 300  $\mu\text{s}$ , Duty Cycle  $\leq 2.0\%$ .

## DEVICE ORDERING INFORMATION

Device Order Number	Package Type	Shipping <sup>†</sup>
MBR30H80CTG	TO-220 (Pb-Free)	50 Units / Rail
MBRB30H80CT-1G	I <sup>2</sup> PAK (Pb-Free)	50 Units / Rail

# MBR30H80CT, MBRB30H80CT-1

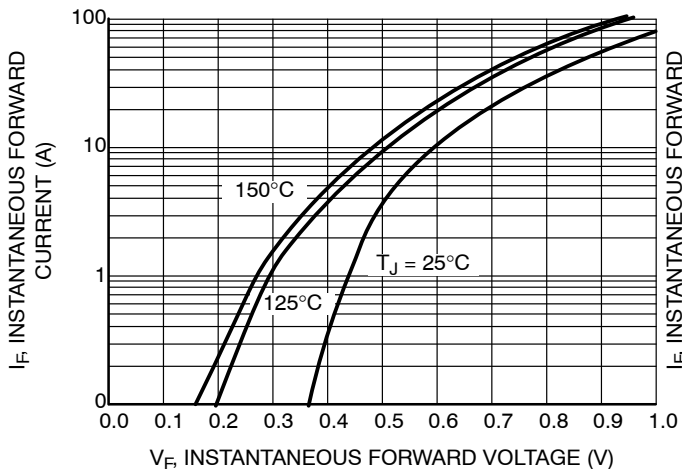

Figure 1. Typical Forward Voltage

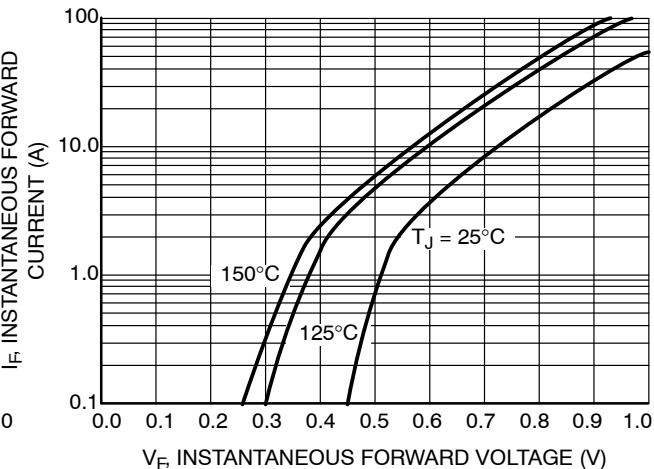

Figure 2. Maximum Forward Voltage

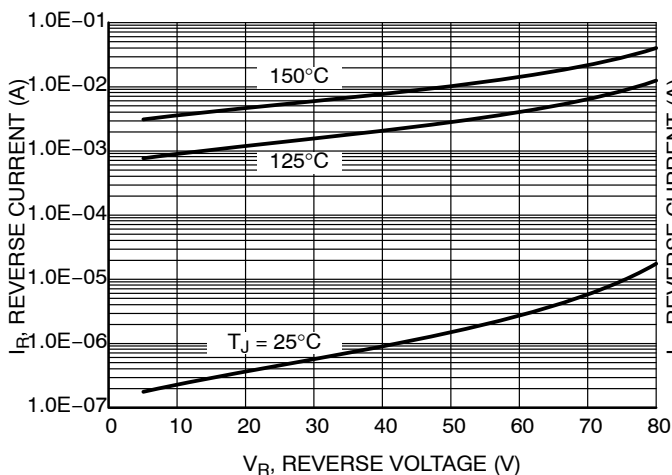

Figure 3. Typical Reverse Current

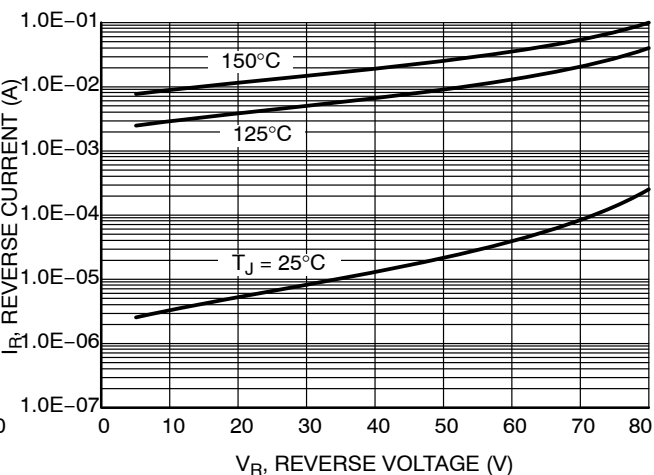

Figure 4. Maximum Reverse Current

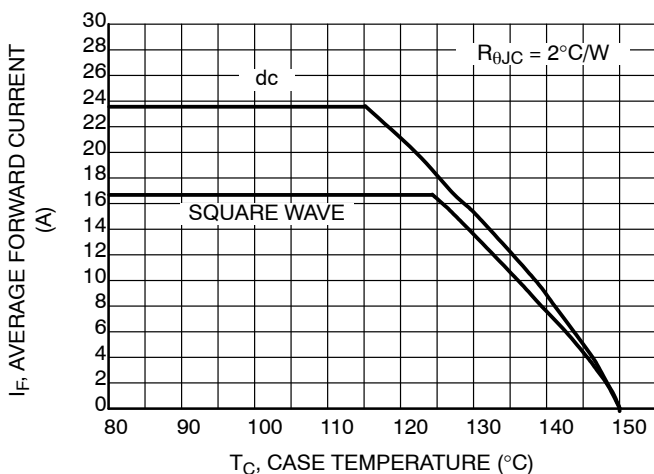

Figure 5. Current Derating, Case per Leg

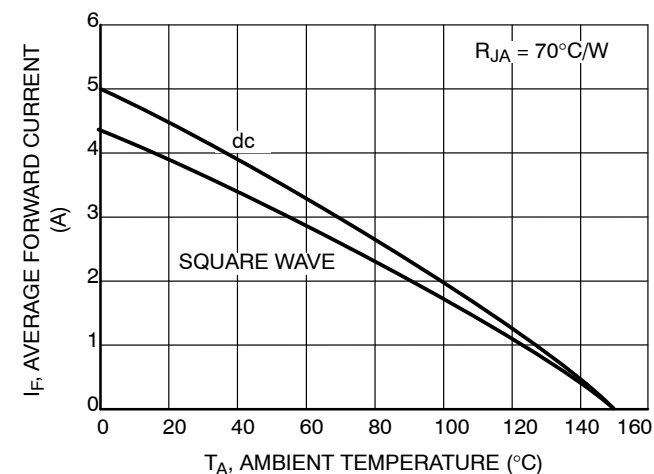

Figure 6. Current Derating, Ambient per Leg

# MBR30H80CT, MBRB30H80CT-1

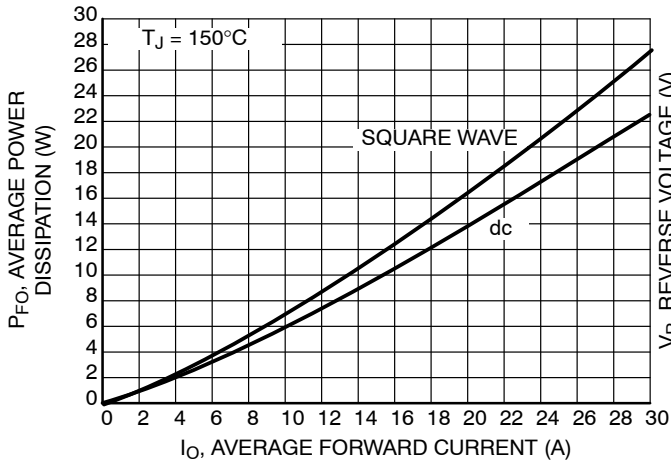

Figure 7. Forward Power Dissipation

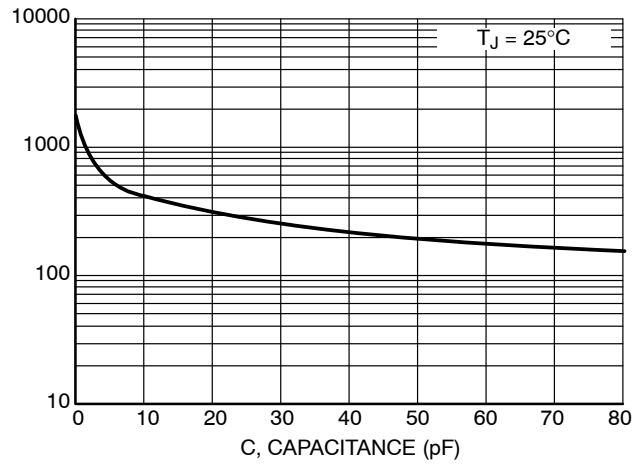

Figure 8. Capacitance

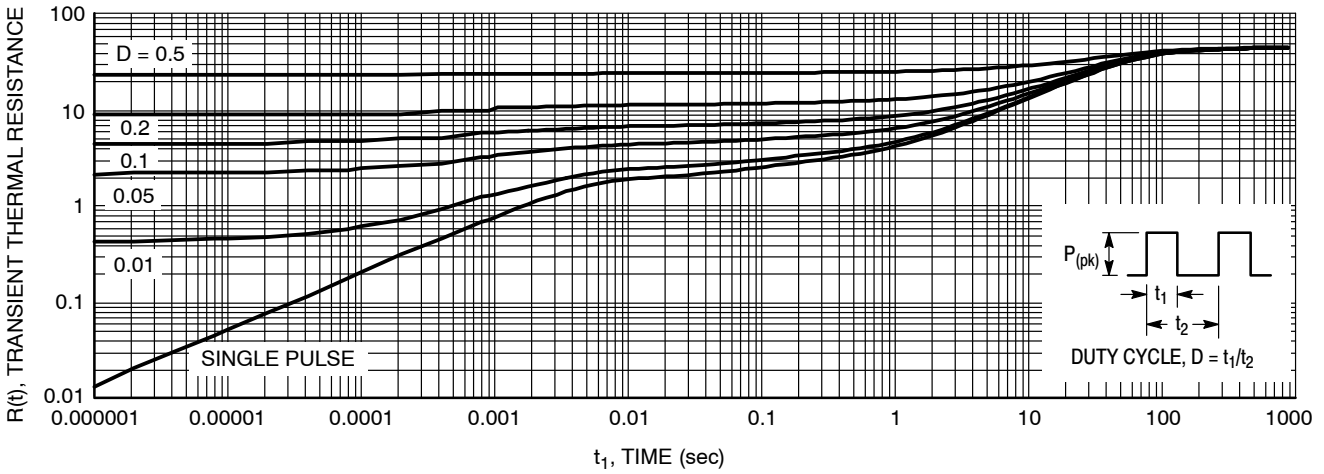

Figure 9. Thermal Response Junction-to-Ambient

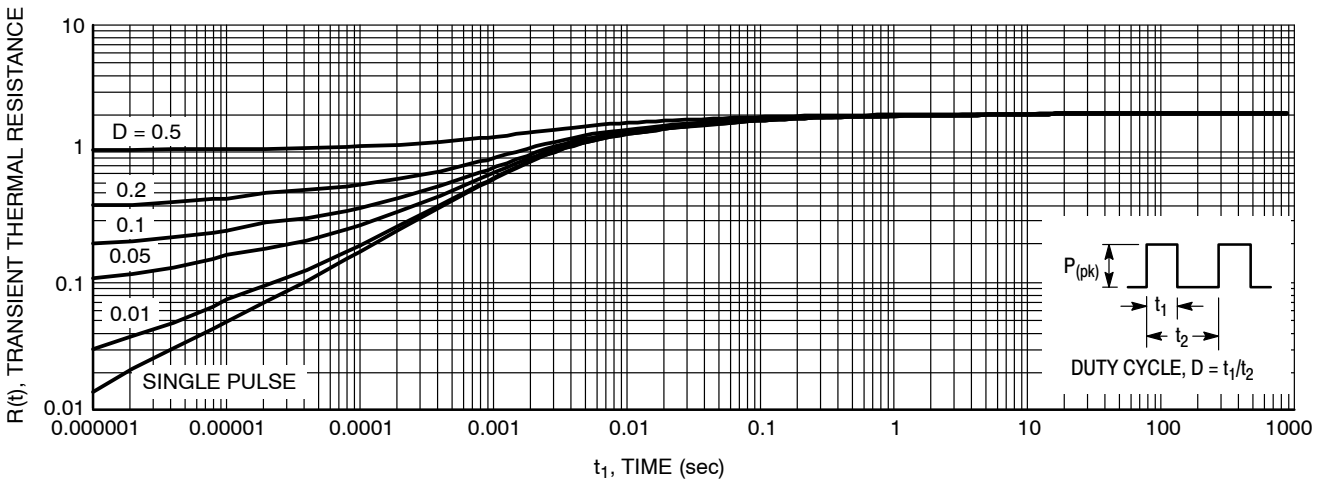
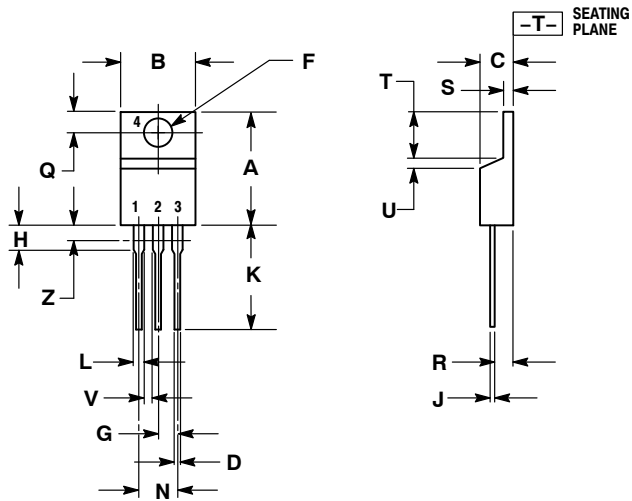

Figure 10. Thermal Response Junction-to-Case

# MBR30H80CT, MBRB30H80CT-1

## PACKAGE DIMENSIONS

TO-220  
CASE 221A-09  
ISSUE AF



NOTES:

1. DIMENSIONING AND TOLERANCING PER ANSI Y14.5M, 1982.
2. CONTROLLING DIMENSION: INCH.
3. DIMENSION Z DEFINES A ZONE WHERE ALL BODY AND LEAD IRREGULARITIES ARE ALLOWED.

DIM	INCHES		MILLIMETERS	
	MIN	MAX	MIN	MAX
A	0.570	0.620	14.48	15.75
B	0.380	0.405	9.66	10.28
C	0.160	0.190	4.07	4.82
D	0.025	0.035	0.64	0.88
F	0.142	0.161	3.61	4.09
G	0.095	0.105	2.42	2.66
H	0.110	0.155	2.80	3.93
J	0.014	0.025	0.36	0.64
K	0.500	0.562	12.70	14.27
L	0.045	0.060	1.15	1.52
N	0.190	0.210	4.83	5.33
Q	0.100	0.120	2.54	3.04
R	0.080	0.110	2.04	2.79
S	0.045	0.055	1.15	1.39
T	0.235	0.255	5.97	6.47
U	0.000	0.050	0.00	1.27
V	0.045	---	1.15	---
Z	---	0.080	---	2.04

STYLE 6:

- PIN 1. ANODE  
2. CATHODE  
3. ANODE  
4. CATHODE

# MBR30H80CT, MBRB30H80CT-1

## PACKAGE DIMENSIONS

I<sup>2</sup>PAK (TO-262)  
CASE 418D-01  
ISSUE D

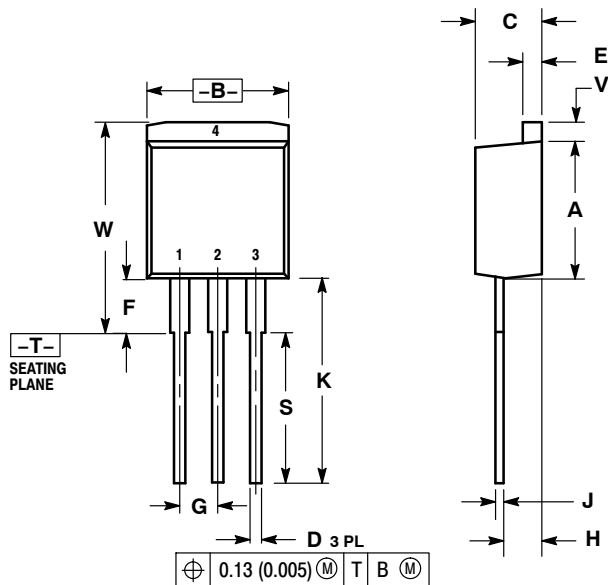

- NOTES:  
1. DIMENSIONING AND TOLERANCING PER ANSI Y14.5M, 1982.  
2. CONTROLLING DIMENSION: INCH.

DIM	INCHES		MILLIMETERS	
	MIN	MAX	MIN	MAX
A	0.335	0.380	8.51	9.65
B	0.380	0.406	9.65	10.31
C	0.160	0.185	4.06	4.70
D	0.026	0.035	0.66	0.89
E	0.045	0.055	1.14	1.40
F	0.122 REF		3.10 REF	
G	0.100 BSC		2.54 BSC	
H	0.094	0.110	2.39	2.79
J	0.013	0.025	0.33	0.64
K	0.500	0.562	12.70	14.27
S	0.390 REF		9.90 REF	
V	0.045	0.070	1.14	1.78
W	0.522	0.551	13.25	14.00

- STYLE 3:  
PIN 1: ANODE  
2: CATHODE  
3: ANODE  
4: CATHODE

SWITCHMODE is a trademark of Semiconductor Components Industries, LLC.

ON Semiconductor and are registered trademarks of Semiconductor Components Industries, LLC (SCILLC). SCILLC reserves the right to make changes without further notice to any products herein. SCILLC makes no warranty, representation or guarantee regarding the suitability of its products for any particular purpose, nor does SCILLC assume any liability arising out of the application or use of any product or circuit, and specifically disclaims any and all liability, including without limitation special, consequential or incidental damages. "Typical" parameters which may be provided in SCILLC data sheets and/or specifications can and do vary in different applications and actual performance may vary over time. All operating parameters, including "Typicals" must be validated for each customer application by customer's technical experts. SCILLC does not convey any license under its patent rights nor the rights of others. SCILLC products are not designed, intended, or authorized for use as components in systems intended for surgical implant into the body, or other applications intended to support or sustain life, or for any other application in which the failure of the SCILLC product could create a situation where personal injury or death may occur. Should Buyer purchase or use SCILLC products for any such unintended or unauthorized application, Buyer shall indemnify and hold SCILLC and its officers, employees, subsidiaries, affiliates, and distributors harmless against all claims, costs, damages, and expenses, and reasonable attorney fees arising out of, directly or indirectly, any claim of personal injury or death associated with such unintended or unauthorized use, even if such claim alleges that SCILLC was negligent regarding the design or manufacture of the part. SCILLC is an Equal Opportunity/Affirmative Action Employer. This literature is subject to all applicable copyright laws and is not for resale in any manner.

### PUBLICATION ORDERING INFORMATION

**LITERATURE FULFILLMENT:**  
Literature Distribution Center for ON Semiconductor  
P.O. Box 5163, Denver, Colorado 80217 USA  
**Phone:** 303-675-2175 or 800-344-3860 Toll Free USA/Canada  
**Fax:** 303-675-2176 or 800-344-3867 Toll Free USA/Canada  
**Email:** orderlit@onsemi.com

**N. American Technical Support:** 800-282-9855 Toll Free  
USA/Canada  
**Europe, Middle East and Africa Technical Support:**  
Phone: 421 33 790 2910  
**Japan Customer Focus Center**  
Phone: 81-3-5773-3850

**ON Semiconductor Website:** [www.onsemi.com](http://www.onsemi.com)  
**Order Literature:** <http://www.onsemi.com/orderlit>

For additional information, please contact your local Sales Representative