

# DATA SHEET

**EP20**

**EP cores and accessories**

Supersedes data of September 2004

2008 Sep 01



**FERROXCUBE**  
A YAGEO COMPANY

**CORE SETS**

**Effective core parameters**

SYMBOL	PARAMETER	VALUE	UNIT
$\Sigma(l/A)$	core factor (C1)	0.520	mm <sup>-1</sup>
$V_e$	effective volume	3230	mm <sup>3</sup>
$l_e$	effective length	41.1	mm
$A_e$	effective area	78.7	mm <sup>2</sup>
$A_{min}$	minimum area	60.8	mm <sup>2</sup>
m	mass of set	≈27	g

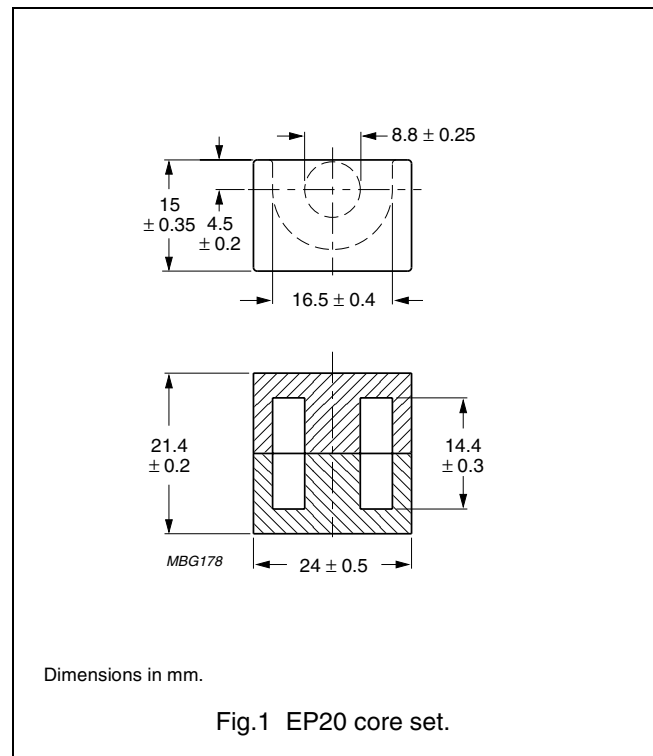

**Core sets for general purpose transformers and power applications**

Clamping force for  $A_L$  measurements, 60 ±20 N.

GRADE	$A_L$ (nH)	$\mu_e$	TOTAL AIR GAP (μm)	TYPE NUMBER
3C81	160 ±3%	≈ 67	≈ 790	EP20-3C81-E160
	250 ±3%	≈ 104	≈ 460	EP20-3C81-A250
	315 ±3%	≈ 131	≈ 350	EP20-3C81-A315
	400 ±3%	≈ 166	≈ 260	EP20-3C81-A400
	630 ±5%	≈ 262	≈ 150	EP20-3C81-A630
	4900 ±25%	≈ 2040	≈ 0	EP20-3C81
3C91 <small>des</small>	4900 ±25%	≈ 2040	≈ 0	EP20-3C91
3C94	160 ±3%	≈ 67	≈ 790	EP20-3C94-E160
	250 ±3%	≈ 104	≈ 460	EP20-3C94-A250
	315 ±3%	≈ 131	≈ 350	EP20-3C94-A315
	400 ±3%	≈ 166	≈ 260	EP20-3C94-A400
	630 ±5%	≈ 262	≈ 150	EP20-3C94-A630
	4435 ±25%	≈ 1840	≈ 0	EP20-3C94
3C96 <small>des</small>	3850 ±25%	≈ 1600	≈ 0	EP20-3C96

GRADE	$A_L$ (nH)	$\mu_e$	TOTAL AIR GAP ( $\mu\text{m}$ )	TYPE NUMBER
3F3	160 $\pm$ 3%	$\approx$ 67	$\approx$ 790	EP20-3F3-E160
	250 $\pm$ 3%	$\approx$ 104	$\approx$ 460	EP20-3F3-A250
	315 $\pm$ 3%	$\approx$ 131	$\approx$ 350	EP20-3F3-A315
	400 $\pm$ 3%	$\approx$ 166	$\approx$ 260	EP20-3F3-A400
	630 $\pm$ 5%	$\approx$ 262	$\approx$ 150	EP20-3F3-A630
	3550 $\pm$ 25%	$\approx$ 1480	$\approx$ 0	EP20-3F3

**Properties of core sets under power conditions**

GRADE	B (mT) at	CORE LOSS (W) at			
	H = 250 A/m; f = 25 kHz; T = 100 °C	f = 25 kHz; $\hat{B}$ = 200 mT; T = 100 °C	f = 100 kHz; $\hat{B}$ = 100 mT; T = 100 °C	f = 100 kHz; $\hat{B}$ = 200 mT; T = 100 °C	f = 400 kHz; $\hat{B}$ = 50 mT; T = 100 °C
3C81	$\geq$ 315	$\leq$ 0.75	–	–	–
3C91	$\geq$ 315	–	$\leq$ 0.2 <sup>(1)</sup>	$\leq$ 1.3 <sup>(1)</sup>	–
3C94	$\geq$ 320	–	$\leq$ 0.25	$\leq$ 1.6	–
3C96	$\geq$ 340	–	$\leq$ 0.2	$\leq$ 1.3	$\leq$ 0.5
3F3	$\geq$ 315	–	$\leq$ 0.36	–	$\leq$ 0.62

**Properties of core sets under power conditions (continued)**

GRADE	B (mT) at	CORE LOSS (W) at			
	H = 250 A/m; f = 25 kHz; T = 100 °C	f = 500 kHz; $\hat{B}$ = 50 mT; T = 100 °C	f = 500 kHz; $\hat{B}$ = 100 mT; T = 100 °C	f = 1 MHz; $\hat{B}$ = 30 mT; T = 100 °C	f = 3 MHz; $\hat{B}$ = 10 mT; T = 100 °C
3C81	$\geq$ 315	–	–	–	–
3C91	$\geq$ 315	–	–	–	–
3C94	$\geq$ 320	–	–	–	–
3C96	$\geq$ 340	$\leq$ 1.0	–	–	–
3F3	$\geq$ 315	–	–	–	–

**Note**

1. Measured at 60 °C.

**COIL FORMER**

**General data**

PARAMETER	SPECIFICATION
Coil former material	phenolformaldehyde (PF), glass-reinforced, flame retardant in accordance with "UL 94V-0"; UL file number E41429(M)
Pin material	copper-clad steel, tin (Sn) plated
Maximum operating temperature	180 °C, "IEC 60085", class H
Resistance to soldering heat	"IEC 60068-2-20", Part 2, Test Tb, method 1B: 350 °C, 3.5 s
Solderability	"IEC 60068-2-20", Part 2, Test Ta, method 1: 235 °C, 2 s

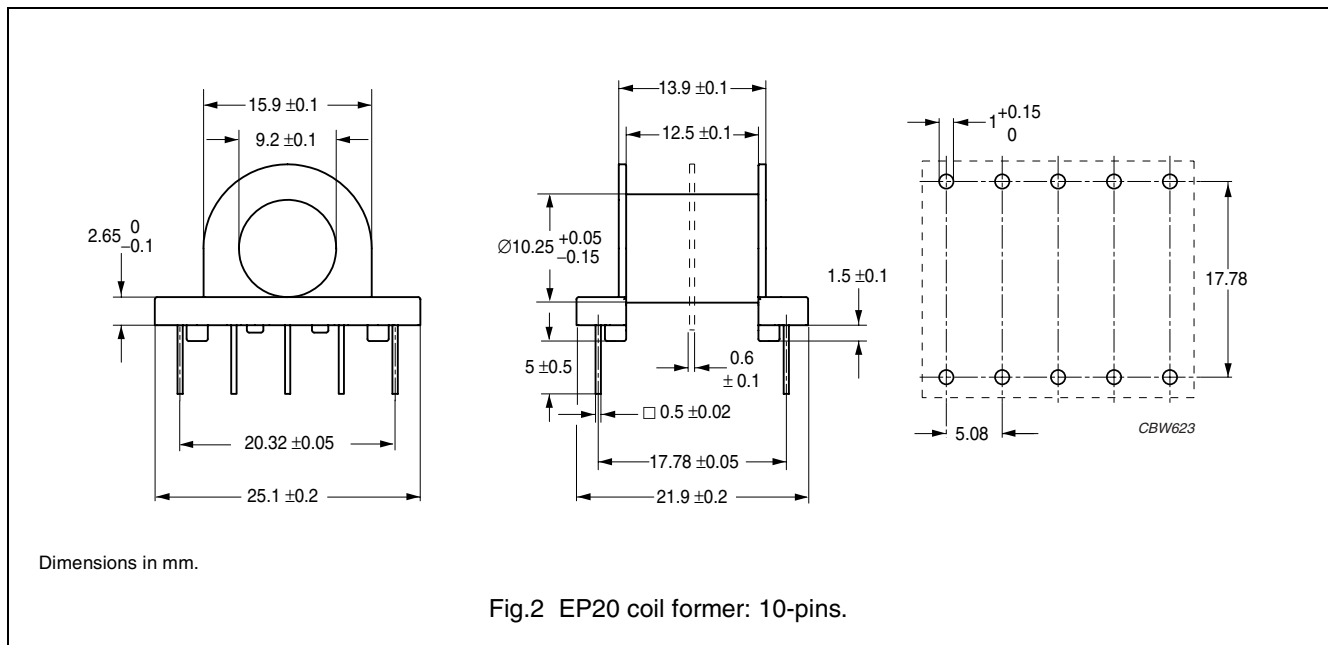

**Winding data and area product for 10-pins EP20 coil former**

NUMBER OF SECTIONS	MINIMUM WINDING AREA (mm <sup>2</sup> )	NOMINAL WINDING WIDTH (mm)	AVERAGE LENGTH OF TURN (mm)	AREA PRODUCT Ae x Aw (mm <sup>4</sup> )	TYPE NUMBER
1	40.3	12.4	39.4	3170	CSH-EP20-1S-10P-T
2	2 x 19.0	2 x 5.95	39.4	2 x 1500	CSH-EP20-2S-10P-T

**MOUNTING PARTS**

**General data**

ITEM	REMARKS	FIGURE	TYPE NUMBER
Clasp	steel, tin (Sn) plated (thickness 3-5 microns)	3	CLA-EP20-Z
Spring	copper-tin alloy (CuSn), tin (Sn) plated	4	SPR-EP20-Z

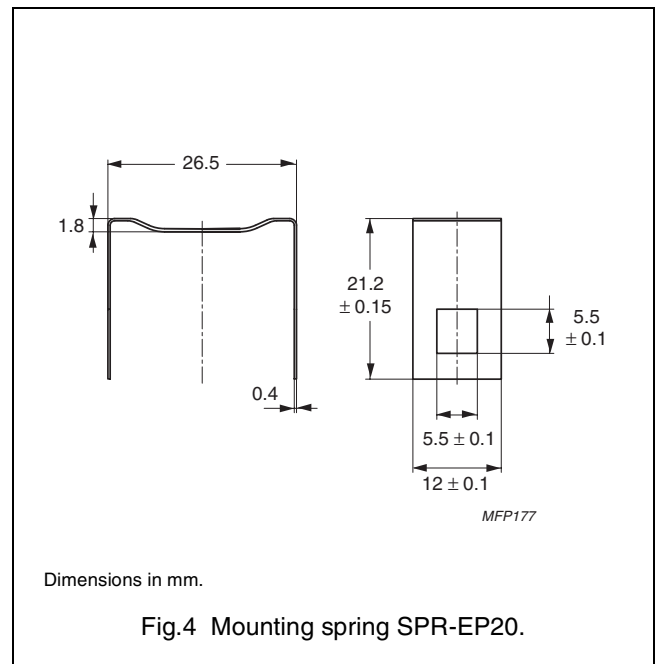
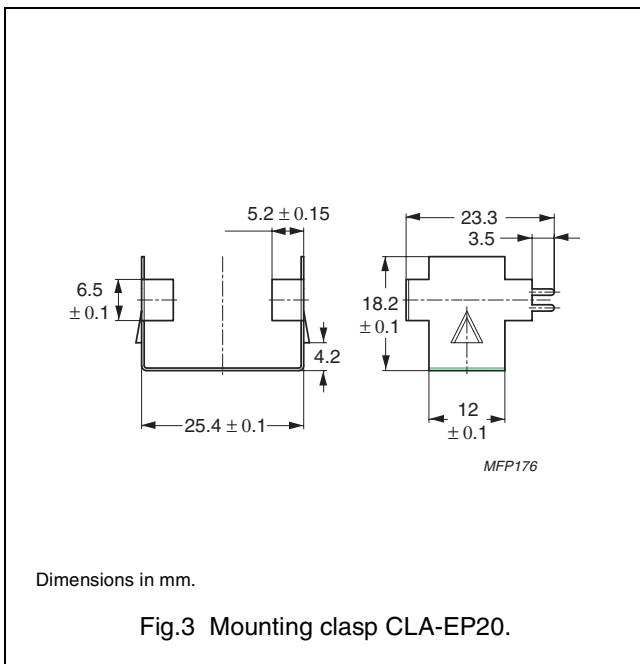



**DATA SHEET STATUS DEFINITIONS**

DATA SHEET STATUS	PRODUCT STATUS	DEFINITIONS
Preliminary specification	Development	This data sheet contains preliminary data. Ferroxcube reserves the right to make changes at any time without notice in order to improve design and supply the best possible product.
Product specification	Production	This data sheet contains final specifications. Ferroxcube reserves the right to make changes at any time without notice in order to improve design and supply the best possible product.

**DISCLAIMER**

**Life support applications** — These products are not designed for use in life support appliances, devices, or systems where malfunction of these products can reasonably be expected to result in personal injury. Ferroxcube customers using or selling these products for use in such applications do so at their own risk and agree to fully indemnify Ferroxcube for any damages resulting from such application.

**PRODUCT STATUS DEFINITIONS**

STATUS	INDICATION	DEFINITION
<b>Prototype</b>		These are products that have been made as development samples for the purposes of technical evaluation only. The data for these types is provisional and is subject to change.
<b>Design-in</b>		These products are recommended for new designs.
<b>Preferred</b>		These products are recommended for use in current designs and are available via our sales channels.
<b>Support</b>		These products are <b>not</b> recommended for new designs and may not be available through all of our sales channels. Customers are advised to check for availability.