



| | |
|-----------|------------|
| Spec. No. | PS-ND-0712 |
| Rev. | A |

PRODUCT SPECIFICATION

Model No : CSS-5160E/CSS-5161E

Descriptions:

- 0.50 Inch Single Digit Alphanumeric Display
- Emitting Color: Orange



| CUSTOMER APPROVED | APPROVED BY | CHECKED BY | PREPARED BY |
|-------------------|-------------|------------|-------------|
| SIGNATURES | | | |
| | | | |

CHINA SEMICONDUCTOR CORPORATION
Address:2FL. NO.909,Chung-Cheng Road,
Chung-Ho City Taipei Hsien,Taiwan.

Tel:886-2-2223-9696
Fax:886-2-2223-9377

OPTO PLUS TECHNOLOGIES CO.,LTD
Address:696 Shun jiang Rd.,Ji Shan St.Shaoxing,
ZheJiang,China

Tel:86-0575-8623888
Fax:86-0575-8623112



| | |
|------------------|------------|
| Spec. No. | PS-ND-0712 |
| Rev. | A |

Model No : CSS-5160E/5161E

Features -

1. 0.50 inch (12.7 mm) digit height.
2. Case mold type.
3. RoHs compliant.
4. Low power consumption.
5. Easy mounting on P.C. board or socket.

Device Selection Guide -

| Part No. | Chip | | Description |
|------------------|--------------|---------------|-----------------------|
| | Material | Emitted Color | |
| CSS-5160E | GaAsP | Orange | Common Anode |
| CSS-5161E | | | Common Cathode |

Package Dimensions -

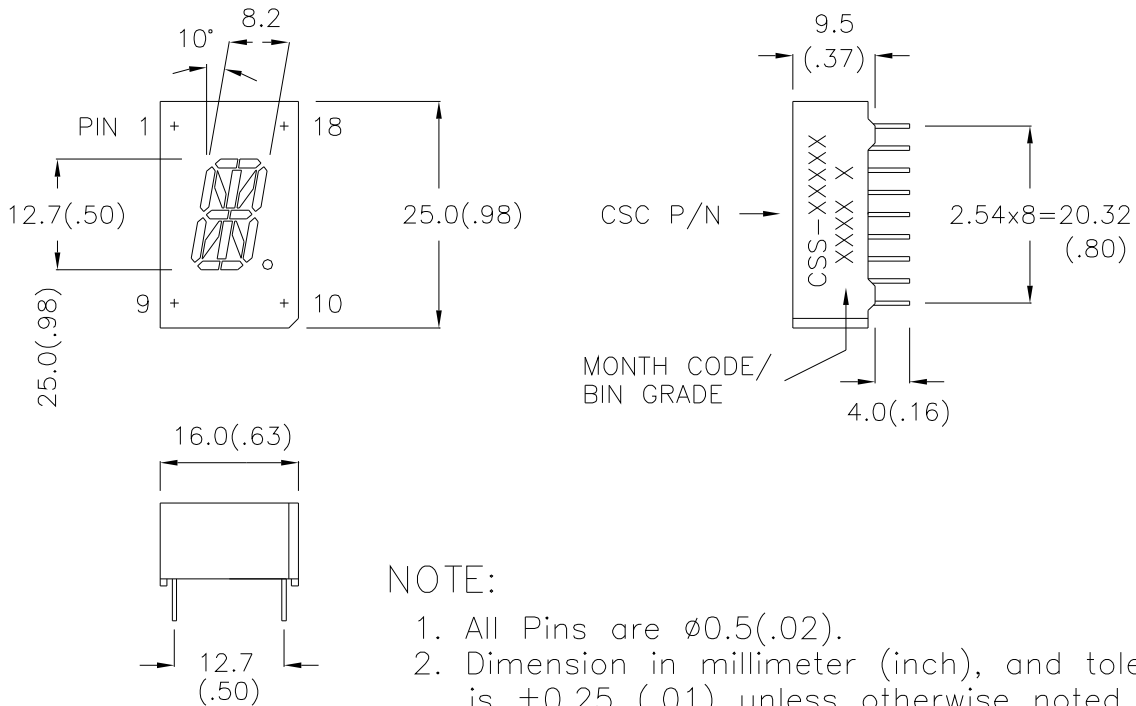

NOTE:

1. All Pins are $\phi 0.5(.02)$.
2. Dimension in millimeter (inch), and tolerance is $\pm 0.25 (.01)$ unless otherwise noted.



Model No : CSS-5160E/5161E

■ Internal Circuit Diagrams -

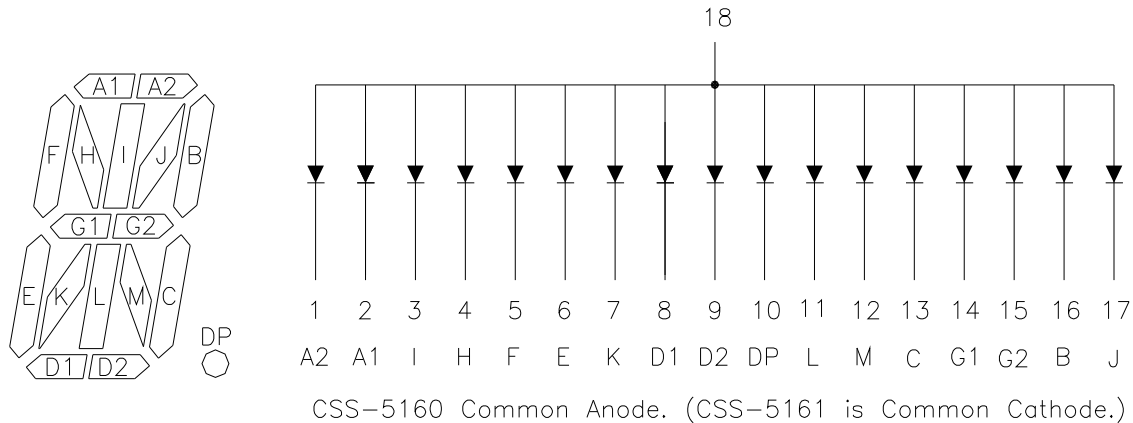

■ Absolute Maximum Rating -

(Ta=25°C)

| Parameter | Symbol | Rating | Unit |
|---|--------|-----------|-------|
| Power Dissipation Per Dice | Pd | 70 | mW |
| Continuous Forward Current Per Dice | IAF | 25 | mA |
| Peak Current Per Dice (duty cycle 1/10, 1kHz) | IPF | 90 | mA |
| Derating Linear From 25°C Per Dice | - | 0.33 | mA/°C |
| Reverse Voltage Per Dice | VR | 5 | V |
| Operating Temperature | Topr | -25 ~ +85 | °C |
| Storage Temperature | Tstg | -25 ~ +85 | °C |
| Solder temperature 1/16 inch below seating plane for 3 seconds at 260 | | | |



| | |
|-----------|------------|
| Spec. No. | PS-ND-0712 |
| Rev. | A |

Model No : CSS-5160E/5161E

■ Electro-optical Characteristics -

(Ta=25°C)

| Parameter | Symbol | Min. | Typ. | Max. | Unit | Condition |
|-----------------------------------|------------------|------|------|-------|---------|-----------|
| Forward Voltage Per Segment | VF | - | 2.0 | 2.8 | V | IF=20mA |
| Luminous Intensity Per Segment | Iv | - | 4 | - | mcd | IF=10mA |
| Peak Emission Wavelength | λ_p | - | 632 | - | nm | IF=20mA |
| Spectrum Radiation Bandwidth | $\Delta \lambda$ | - | 35 | - | nm | IF=20mA |
| Reverse Current | IR | - | - | 100 | μA | VR=5V |
| Luminous Intensity Matching Ratio | IV-m | - | - | 2 : 1 | - | IF=20mA |



| | |
|-----------|------------|
| Spec. No. | PS-ND-0712 |
| Rev. | A |

Model No : CSS-5160E/5161E

Typical Electrical / Optical Characteristics Curves -

(Ta = 25°C Unless Otherwise Noted)

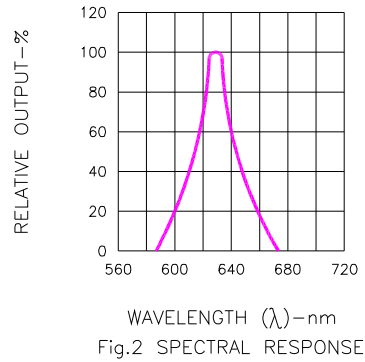
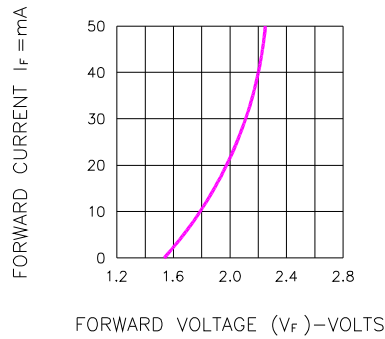

Fig.2 SPECTRAL RESPONSE

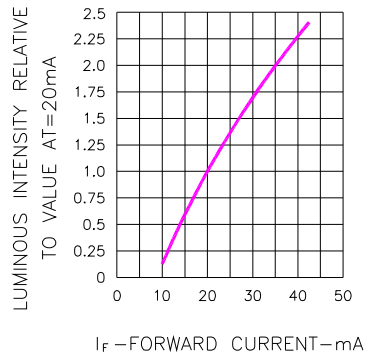

Fig.3 RELATIVE LUMINOUS INTENSITY VS. FORWARD CURRENT

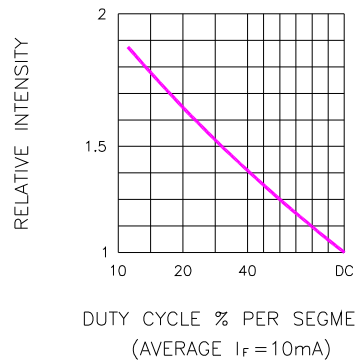

Fig.5 LUMINOUS INTENSITY VS. DUTY CYCLE

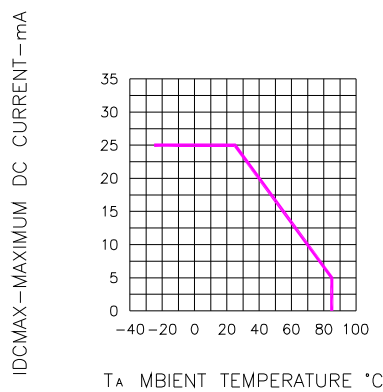

Fig.4 MAXIMUM ALLOWABLE DC CURRENT PER SEGMENT VS. A FUNCTION OF AMBIENT TEMPERATURE

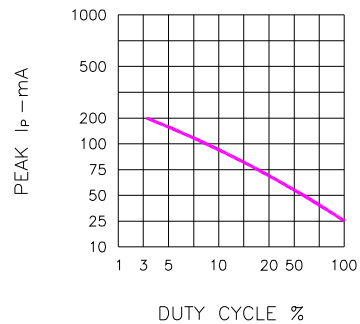

Fig.6 MAX PEAK CURRENT VS. DUTY CYCLE % (REFRESH RATE f=1 KHz)



| | |
|-----------|------------|
| Spec. No. | PS-ND-0712 |
| Rev. | A |

Model No : CSS-5160E/5161E

■ Package Dimensions

S = Single Digit Display
Dice Code
CSS-516xX-XX
Segment Resin Color Code.
Surface silk Screen Ink Code.

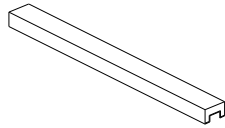

1 TUBE From Box = 20 PCS

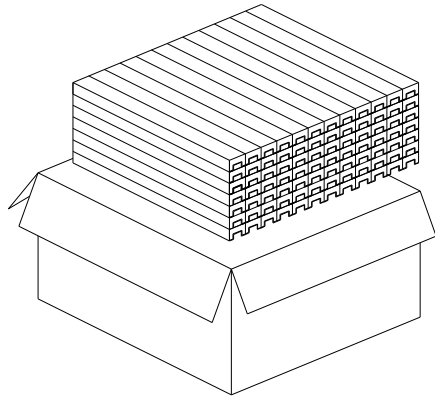

1 BOX= 60 TUBE From Box
Q'TY: 1200 PCS.



1 CARTON = 3 BOX.
Q'TY: 3600 PCS.

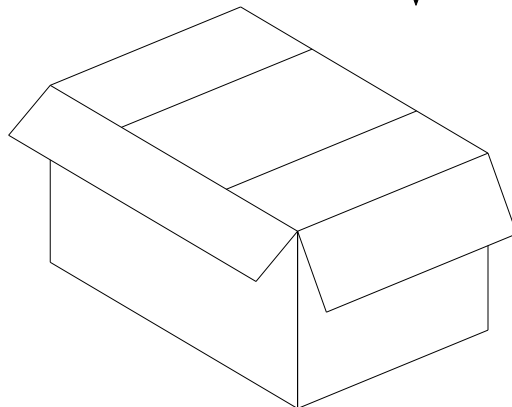

CARTON SIZE:
L540xW485xH305mm

Note: The specifications are subject to change without notice. Please contact us for updated information.