



Spec. No.	PS-ND-0712
Rev.	A

# PRODUCT SPECIFICATION

**Model No : CSS-1116G/CSS-1117G**

## Descriptions:

- 1.0 Inch Single Digit Alphanumeric Display
- Emitting Color: Yellow Green



CUSTOMER APPROVED	APPROVED BY	CHECKED BY	PREPARED BY
SIGNATURES			

**CHINA SEMICONDUCTOR CORPORATION**  
Address:2FL. NO.909,Chung-Cheng Road,  
Chung-Ho City Taipei Hsien,Taiwan.

Tel:886-2-2223-9696  
Fax:886-2-2223-9377

**OPTO PLUS TECHNOLOGIES CO.,LTD**  
Address:696 Shun jiang Rd.,Ji Shan St.Shaoxing,  
ZheJiang,China

Tel:86-0575-8623888  
Fax:86-0575-8623112



<b>Spec. No.</b>	PS-ND-0712
<b>Rev.</b>	A

**Model No : CSS-1116G/1117G**

**Features -**

1. 1.00 inch (25.4 mm) digit height.
2. Case mold type.
3. RoHs compliant.
4. Low power consumption.
5. Easy mounting on P.C. board or socket.

**Device Selection Guide -**

Part No.	Chip		Description
	Material	Emitted Color	
CSS-1116G	GaP	Yellow Green	Common Anode
CSS-1117G			Common Cathode

**Package Dimensions -**

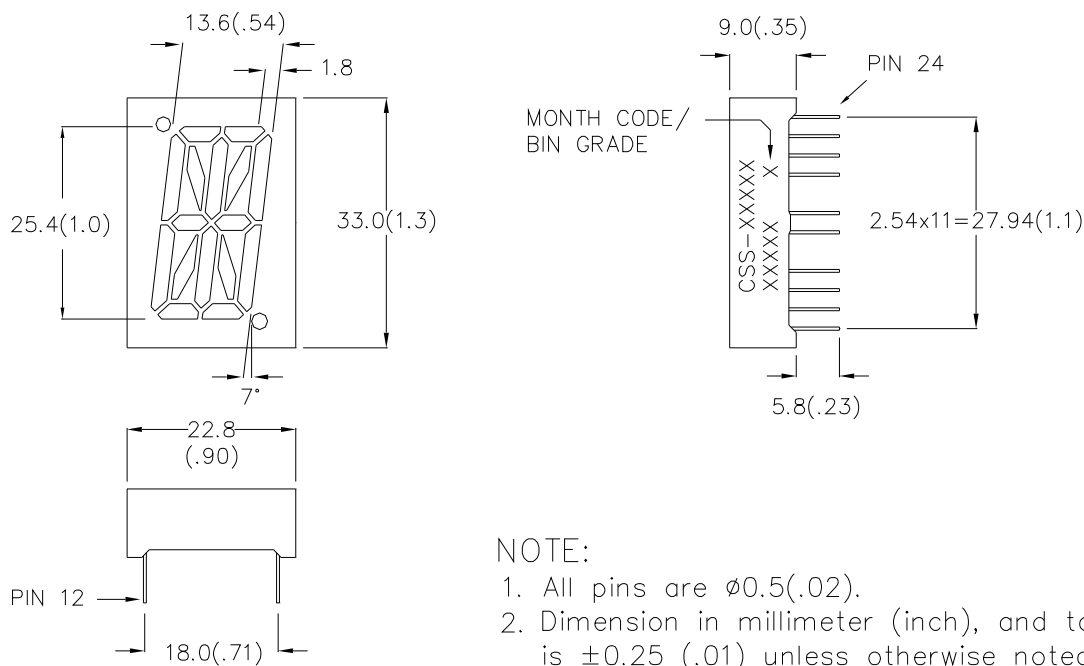

**NOTE:**

1. All pins are  $\phi 0.5(.02)$ .
2. Dimension in millimeter (inch), and tolerance is  $\pm 0.25 (.01)$  unless otherwise noted.



**Model No : CSS-1116G/1117G**

**Internal Circuit Diagrams -**

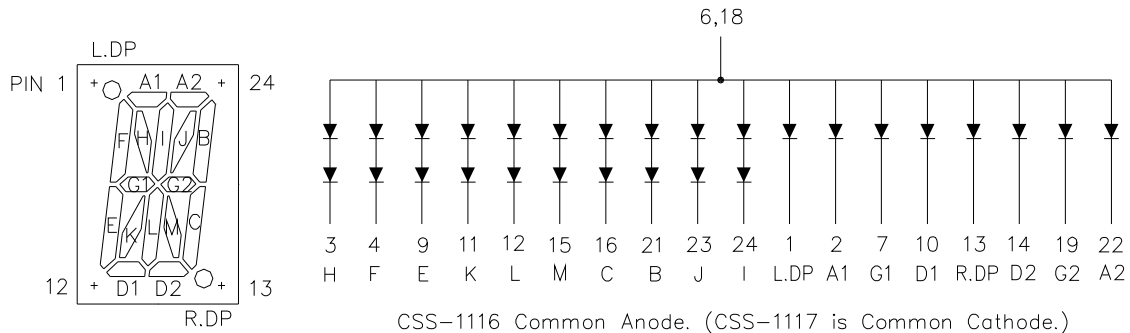

CSS-1116 Common Anode. (CSS-1117 is Common Cathode.)  
NO. 5, 8, 17, 20 No Pin.

**Absolute Maximum Rating -**

(Ta=25°C)

Parameter	Symbol	Rating	Unit
Power Dissipation Per Dice	Pd	70	mW
Continuous Forward Current Per Dice	IAF	25	mA
Peak Current Per Dice (duty cycle 1/10, 1kHz)	IPF	90	mA
Derating Linear From 25°C Per Dice	-	0.33	mA/°C
Reverse Voltage Per Dice	VR	5	V
Operating Temperature	Topr	-25 ~ +85	°C
Storage Temperature	Tstg	-25 ~ +85	°C
Solder temperature 1/16 inch below seating plane for 3 seconds at 260 °C			



Spec. No.	PS-ND-0712
Rev.	A

Model No : CSS-1116G/1117G

■ Electro-optical Characteristics -

(Ta=25°C)

Parameter	Symbol	Min.	Typ.	Max.	Unit	Condition
Forward Voltage Two Dice (One Dice)	VF	-	4.2(2.1)	5.6(2.8)	V	IF=20mA
Luminous Intensity Per Segment	Iv	-	8	-	mcd	IF=10mA
Peak Emission Wavelength	$\lambda_p$	-	570	-	nm	IF=20mA
Spectrum Radiation Bandwidth	$\Delta \lambda$	-	30	-	nm	IF=20mA
Reverse Current	IR	-	-	100	$\mu A$	VR=10V
Luminous Intensity Matching Ratio	IV-m	-	-	2 : 1	-	IF=20mA



Spec. No.	PS-ND-0712
Rev.	A

**Model No : CSS-1116G/1117G**

**Typical Electrical / Optical Characteristics Curves -**

**(Ta = 25°C Unless Otherwise Noted)**

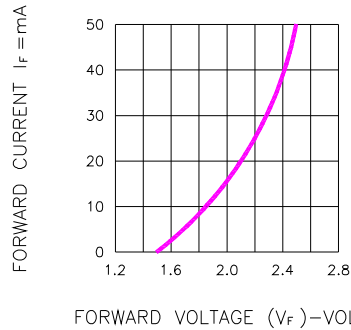

Fig.1 FORWARD CURRENT VS. FORWARD VOLTAGE

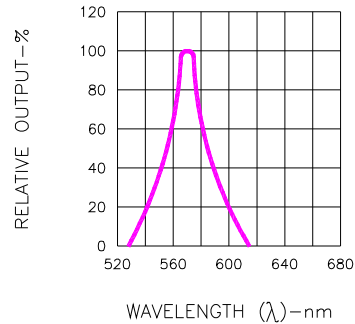

Fig.2 SPECTRAL RESPONSE

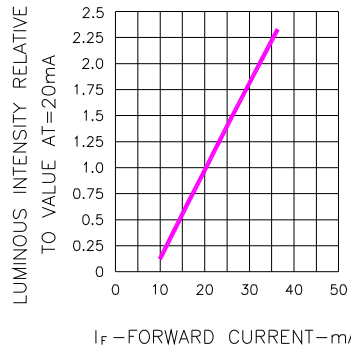

Fig.3 RELATIVE LUMINOUS INTENSITY VS. FORWARD CURRENT

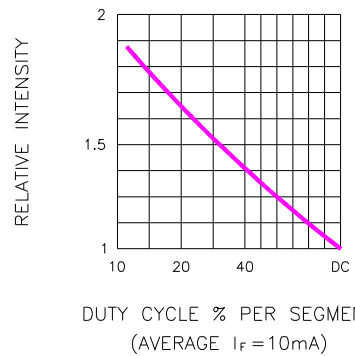

Fig.5 LUMINOUS INTENSITY VS. DUTY CYCLE

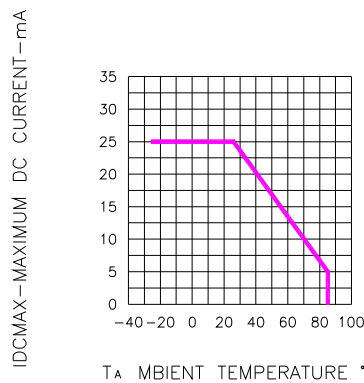

Fig.4 MAXIMUM ALLOWABLE DC CURRENT PER SEGMENT VS. A FUNCTION OF AMBIENT TEMPERATURE

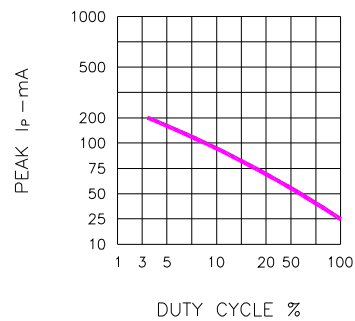

Fig.6 MAX PEAK CURRENT VS. DUTY CYCLE % (REFRESH RATE f=1 KHz)



Spec. No.	0
Rev.	A

**Model No : CSS-1116G/1117G**

**Package Dimensions**

S = Single Digit Displays  
Dice Code  
CSS-1116X-21  
Segment Resin Color Code. 1=White Segment.  
Surface silk Screen Ink Code. 2=Black (1=Gray).

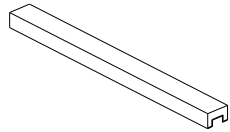

1 TUBE From Box = 15 PCS

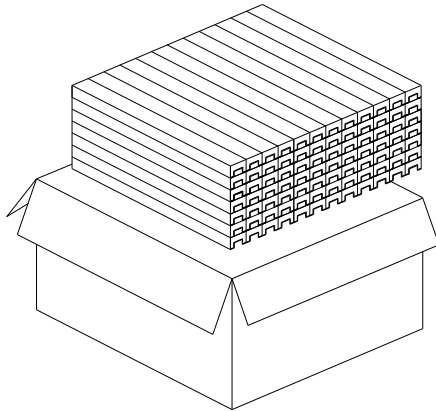

1 BOX= 50 TUBE From Box  
Q'TY: 750 PCS.



1 CARTON = 3 BOX.  
Q'TY: 2250 PCS.

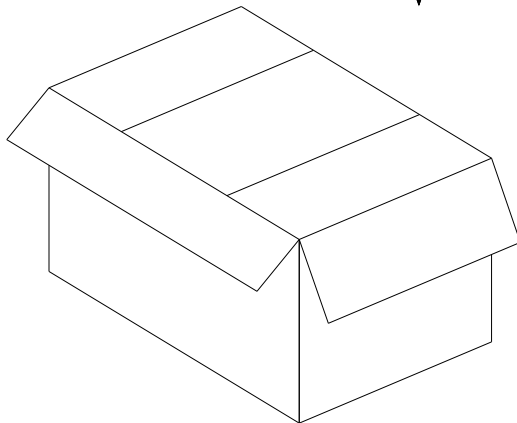

CARTON SIZE:  
L540xW485xH305mm

