

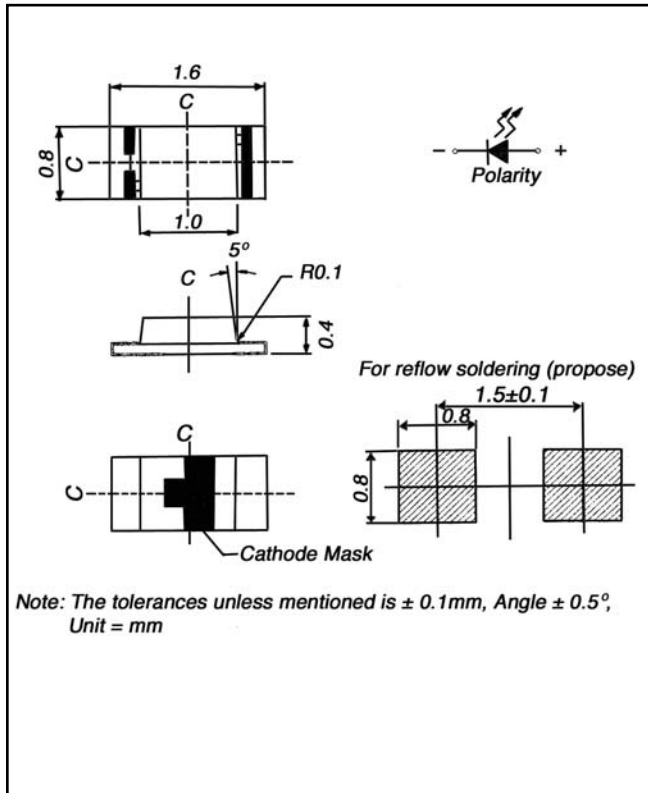

AND7RA

InGaAlP Ultra Bright Red Light Low Profile Surface Mount Package



Features

- 0.40 mm height
- Compatible with automatic placement equipment.
- Compatible w/ infrared & vapor phase reflow solder process.
- RoHS Compliant

Applications

- Backlighting in auto dashboard & switch.
- Flat backlight for LCD, switch & symbol.
- General use for miniature applications.

Maximum Ratings (T_a = 25°C)

Characteristics	Symbol	Rating	Unit
Forward Current	I _F	25	mA
Reverse Voltage	V _R	5	V
Power Dissipation	P _D	60	mW
Operating Temp. Range	T _{Opr}	-40~ +85	°C
Storage Temp. Range	T _{Stg}	-40~ +90	°C
Soldering Temp. (for 5 seconds)	T _{Sol}	260	°C
Electrostatic Discharge	ESD	2000	V
Peak Forward Current (Duty 1/10 @ 1KHz)	I _F	60	mA

Electro-Optical Characteristics (T_a = 25°C)

Characteristics	Symbol	Test Condition	Minimum	Typical	Maximum	Unit
Forward Voltage	V _F	I _F = 5 mA	-	1.6	-	V
Forward Voltage	V _F	I _F = 20 mA	-	2.0	2.4	V
Reverse Current	I _R	V _R = 5 V	-	-	10	µA
Luminous Intensity	I _V	I _F = 5 mA	-	45	-	mcd
Luminous Intensity	I _V	I _F = 20 mA	90	135	-	mcd
Peak Wavelength	λ _P	I _F = 20 mA	-	632	-	nm
Spectral Line Half Width	Δλ	I _F = 20 mA	-	20	-	nm
Dominant Wavelength	λ _d	I _F = 20 mA	-	624	-	nm
Full Viewing Angle	2 θ 1/2	I _F = 20 mA	-	120	-	degree

Recommended solder condition

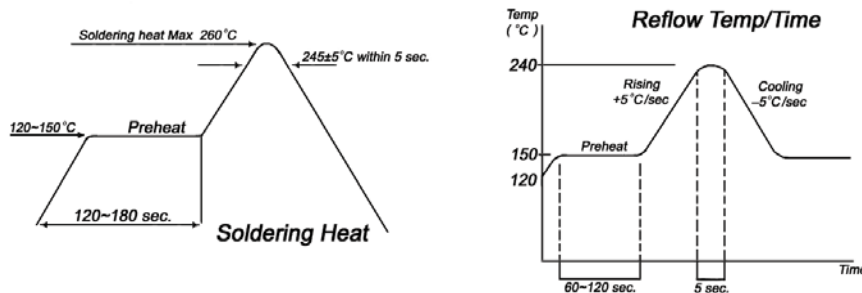

Product specifications contained herein may be changed without prior notice.

It is therefore advisable to contact Purdy Electronics before proceeding with the design of equipment incorporating this product.

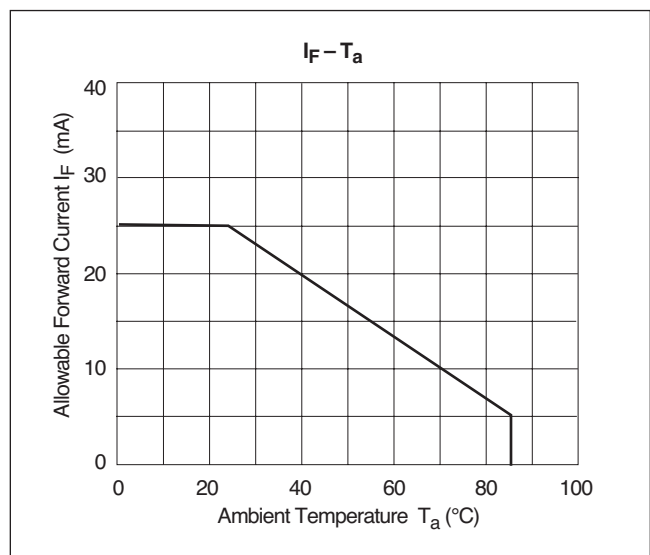
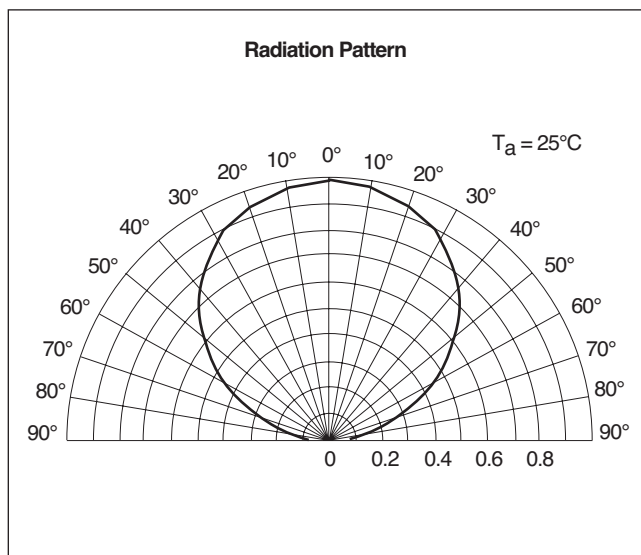
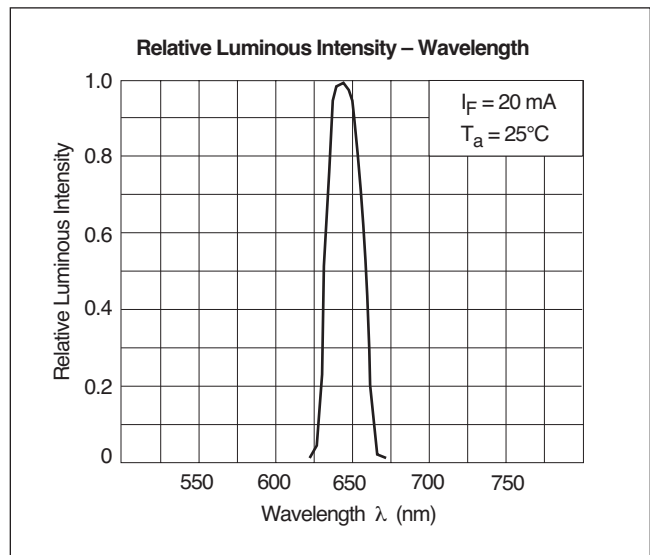
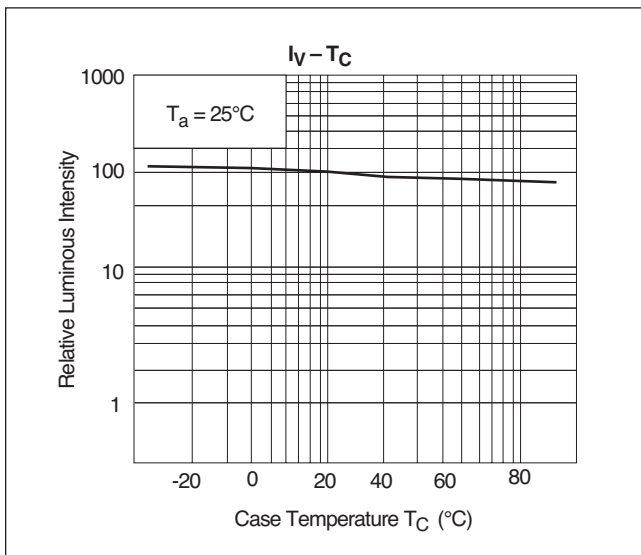
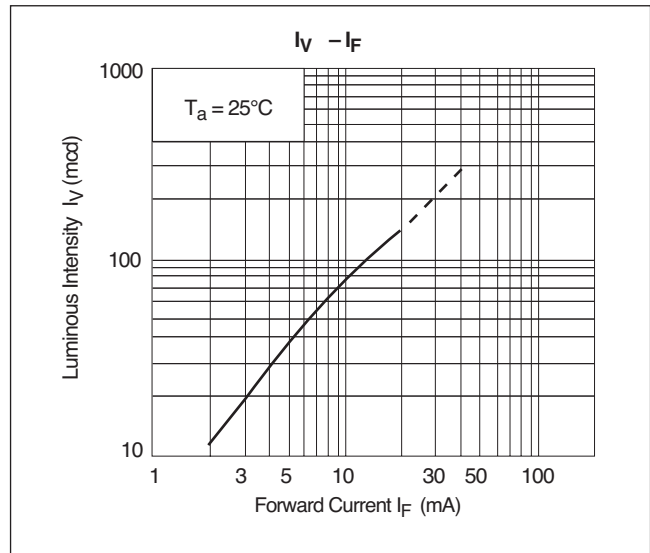
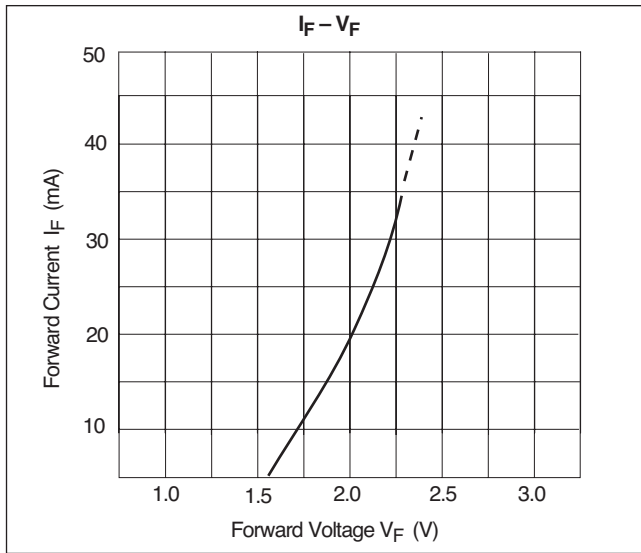



InGaAlP Ultra Bright Red Light

AND7RA
Ultra Bright LED Lamps



InGaAlP Ultra Bright Red Light

AND7RA
Ultra Bright LED Lamps
