

## SECURE DIGITAL

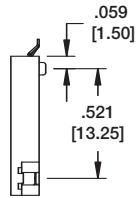

**SD-09-A-SG (Normal Type)**  
**SDR-09-A-SG (Reverse Type)**

## SECURE DIGITAL W/ METAL COVER

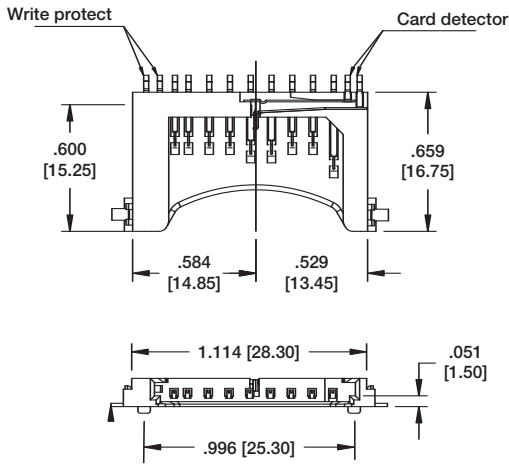
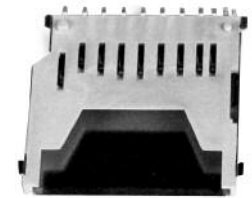
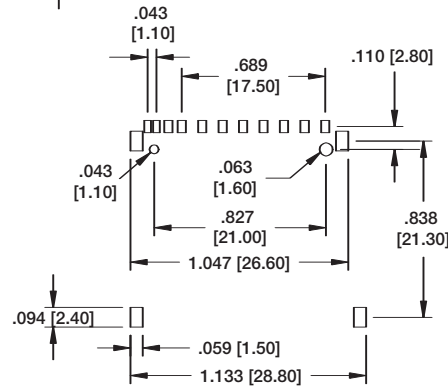
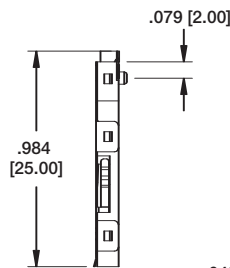
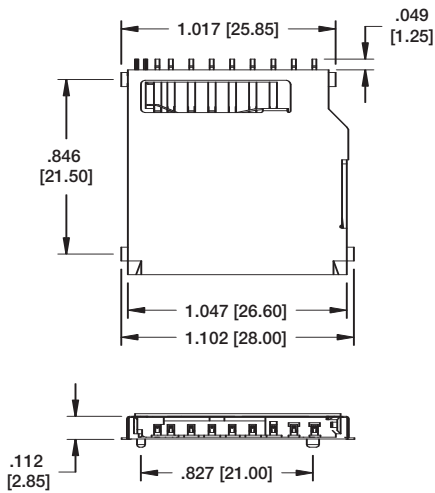

**SDM-09-A-SG-0 (Normal Type)**

## SECURE DIGITAL PUSH-IN/PUSH-OUT

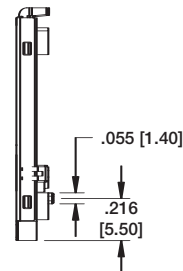
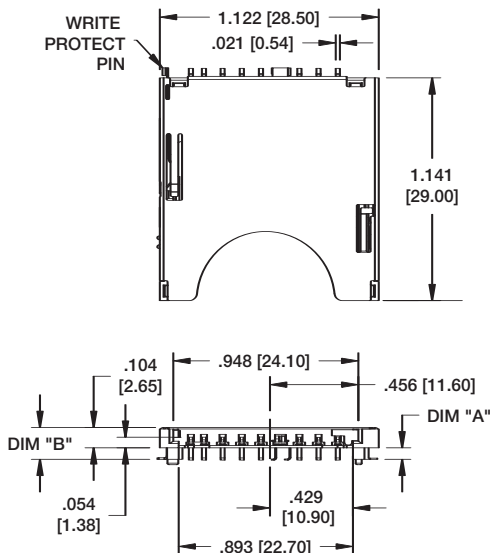

**Part Nos. Available**  
**SDP-09-SG-A (Normal Type, No Standoff)**  
**SDP-09-SG-B (Normal Type, 1.5mm Standoff)**  
**SDP-09-SG-C (Normal Type, 1.8mm Standoff)**  
**SDP-09-SG-D (Normal Type, 2.2mm Standoff)**  
**SDPR-09-SG-A (Reverse Type, No Standoff)**

PART NO.	DIM A	DIM B
SDP-09-SG-A	.00 [0.00]	.104 [2.65]
SDP-09-SG-B	.059 [1.50]	.163 [4.15]
SDP-09-SG-C	.071 [1.80]	.175 [4.45]
SDP-09-SG-D	.086 [2.20]	.190 [4.85]

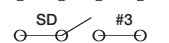

WITHOUT CARD

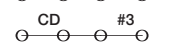

WITH CARD  
WRITE PROTECT  
(LOCKED)

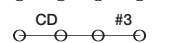

WITH CARD  
WRITE PROTECT  
(UNLOCKED)