

# LDS6023

## PureTouch™ Capacitance Touch IC with Integrated Keypad LED Drivers

The LDS6023 PureTouch™ controller empowers system designers to create streamlined, attractive and reliable product designs with capacitive touch controls. Integrated LED drivers allow visual feedback to be implemented when a touch occurs, without the need for host intervention.

### LDS6023 Features

#### Versatile, accurate capacitance-to-digital converter (CDC)

- 500 kHz sigma-delta CDC
- 6 capacitance sensor input channels
- 2 ms update rate per active sensor

#### Integrated keypad LED drivers

- C3-C5 sensor inputs configurable as keypad LED drivers
- 7.75 mA maximum driving current (up to 23 mA available by connecting multiple outputs to a single LED)
- Flexible dimming control
- Processor-free synchronization with touch events

#### Integrated, automatic calibration algorithms

- Environmental compensation
- On-chip RAM to store calibration data

#### Integrated touch preference modes

- Strongest single touch
- Strongest two touches
- Unrestricted (all) touches

#### Ultra-low touch sensor power consumption\*

- Operating mode (typical): <math>< 150 \mu\text{W}</math> ( $V_{DD1}=1.8\text{V}</math>)$
- Shutdown mode (typical): <math>< 1 \mu\text{W}</math> ( $V_{DD1}=1.8\text{V}</math>)$

\* Excludes LED driver current and I/F and voltage dependent  $V_{DDIO}$  current

## Description

The LDS6023 is a programmable capacitance-to-digital converter (CDC) designed for use with capacitive sensor arrays implementing touch-based input controls including sliders, scroll wheels, and buttons. Featuring 6 sensor inputs, 3 of which are dual-purpose I/Os configurable as either capacitive sensor inputs or keypad LED drivers, the LDS6023 provides the flexibility to implement multiple touch inputs with integrated lighting effects using a single controller.

When configured for capacitive sensing, the I/Os are directed through an integrated switch matrix to a 500 kHz sigma-delta CDC which senses changes in the external sensor array. When a sufficiently large change in capacitance occurs, a sensor activation is registered and the host processor is notified. LED lighting effects are automatically initiated by a touch event with no processor intervention required.

On-chip calibration logic continuously monitors the environment and automatically adjusts on-and-off threshold levels to prevent false sensor activation. The LDS6023 is offered with both SPI-compatible and I<sup>2</sup>C-compatible interfaces (active interface selected by I/F select pin) and features a general-purpose input/output (GPIO) and interrupt output for additional communication with the host processor.

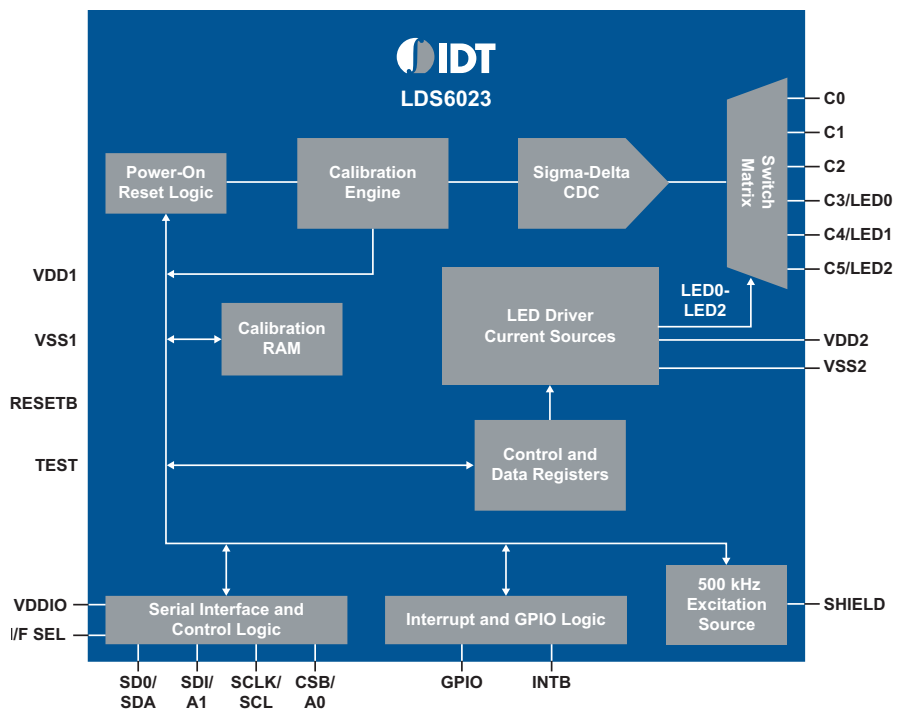

Figure 1. LDS6023 block diagram

### Flexible interface options

- SPI-compatible serial I/F
- I<sup>2</sup>C-compatible serial I/F
- Separate V<sub>DDIO</sub> level for serial interface
- GPIO and Interrupt Output

### Flexible package options

- 28 pin 4mm x 4mm QFN, 0.8mm max height
- 28 pin 5.3mm x 10.2mm SSOP, 1.83mm max height

### Power supply range

- Touch supply (VDD1): 1.65V - 1.95V
- LED supply (VDD2): 3.0V - 5.5V
- V<sub>DDIO</sub> = 1.65V - 3.6V

### Applications

- Mobile handsets and smartphones
- Personal music and media players (MP3/MP4)
- Gaming devices
- Remote controls
- Television, audio/video
- Set-top boxes
- Multi-function printers
- Enterprise telephony

## Integrated keypad LED drivers

The LDS6023 features integrated keypad LED drivers enabling the implementation of visual feedback for touch-based controls and fun lighting effects. The keypad LEDs may be powered either from V<sub>battery</sub> directly or from a regulated voltage supply. On/off transition times are programmed globally for all LEDs and maximum current may be programmed for each LED individually. LEDs may be either manually controlled or synchronized to automatically trigger when a touch event occurs.

## Ideal solution for portable applications

The LDS6023 is optimized for minimal power consumption, with touch sensor circuits operating from a 1.8V supply voltage. In full power mode, sensor conversion and calibration occur continuously, minimizing the time between touch event and touch detection. With its ultra-low touch sensor power consumption of <150 uW (typical), the LDS6023 may be operated continuously in full power mode, eliminating the need for introduced latencies that can cause noticeable delays and degrade the user experience.

The total solution footprint is also optimized for portable applications, with the functionality of multiple components consolidated into a single device. With integrated keypad LED driver functionality, the LDS6023 is a flexible solution combining the functionality of two discrete ICs into a compact 4mm x 4mm TQFN package with 0.75mm package thickness (SSOP package also available).

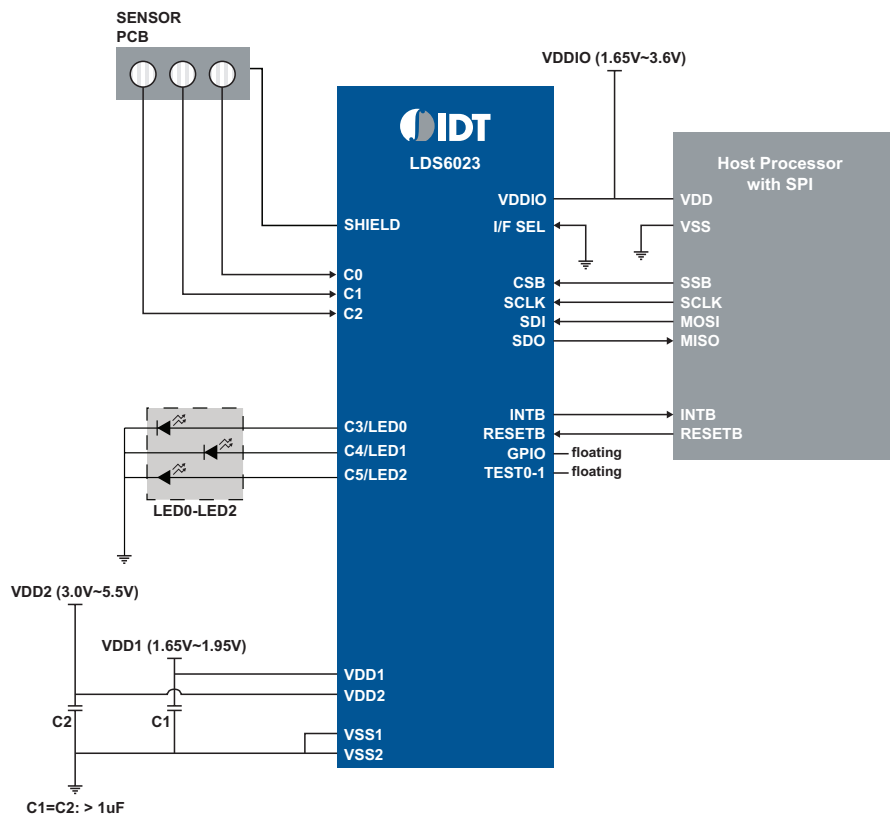

Figure 2. LDS6023 application diagram

Discover what IDT know-how can do for you.

[www.IDT.com/go/touch](http://www.IDT.com/go/touch)



© 2009 Integrated Device Technology, Inc. All rights reserved. Product specifications subject to change without notice. IDT and the IDT logo are registered trademarks of Integrated Device Technology, Inc. All other brands, product names and marks are or may be trademarks or registered trademarks used to identify products or services of their respective owners.

Printed in USA 08-09/MG/BWD/PDF\_r7\_v1

FLYR-LDS6023-089