

**Features**

- 0.56 INCH DIGIT HEIGHT.
- LOW CURRENT OPERATION.
- EXCELLENT CHARACTER APPEARANCE.
- EASY MOUNTING ON P.C. BOARDS OR SOCKETS.
- I.C. COMPATIBLE.
- MECHANICALLY RUGGED.
- GRAY FACE, WHITE SEGMENT.
- RoHS COMPLIANT.

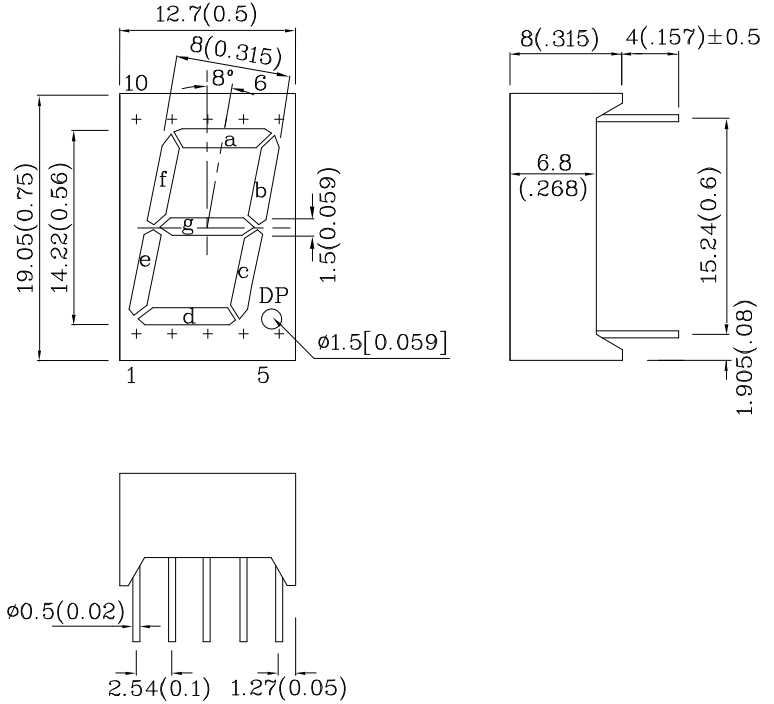
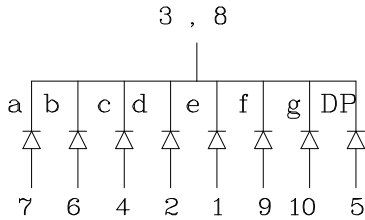

Notes:

1. All dimensions are in millimeters (inches).
2. Tolerance is  $\pm 0.25(0.01)$ " unless otherwise noted.
3. Specifications are subject to change without notice.

| Absolute Maximum Ratings<br>(TA=25°C)                          |                        | MR<br>(GaAlAs) | Unit |
|--|------------------------|----------------|------|
| Reverse Voltage  | V <sub>R</sub>         | 5              | V    |
| Forward Current  | I <sub>F</sub>         | 30             | mA   |
| Forward Current (Peak)<br>1/10 Duty Cycle<br>0.1ms Pulse Width | i <sub>FS</sub>        | 155            | mA   |
| Power Dissipation  | P <sub>T</sub>         | 75             | mW   |
| Operating Temperature  | T <sub>A</sub>         | -40 ~ +85      | °C   |
| Storage Temperature  | T <sub>stg</sub>       | -40 ~ +85      |      |
| Lead Solder Temperature<br>[2mm Below Package Base]            | 260°C For 3 -5 Seconds |                |      |

| Operating Characteristics<br>(TA=25°C)                                       |                | MR<br>(GaAlAs) | Unit |
|--|----------------|----------------|------|
| Forward Voltage (Typ.)<br>(I <sub>F</sub> =10mA)                             | V <sub>F</sub> | 1.8            | V    |
| Forward Voltage (Max.)<br>(I <sub>F</sub> =10mA)                             | V <sub>F</sub> | 2.5            | V    |
| Reverse Current (Max.)<br>(V <sub>R</sub> =5V)                               | I <sub>R</sub> | 10             | uA   |
| Wavelength of Peak<br>Emission (Typ.)<br>(I <sub>F</sub> =10mA)              | λ <sub>P</sub> | 660            | nm   |
| Wavelength of Dominant<br>Emission (Typ.)<br>(I <sub>F</sub> =10mA)          | λ <sub>D</sub> | 640            | nm   |
| Spectral Line Full Width At<br>Half-Maximum (Typ.)<br>(I <sub>F</sub> =10mA) | Δλ             | 20             | nm   |
| Capacitance (Typ.)<br>(V <sub>F</sub> =0V, f=1MHz)                           | C              | 45             | pF   |

| Part Number | Emitting Color | Emitting Material | Luminous Intensity (I <sub>F</sub> =10mA)<br>ucd |       | Wavelength<br>nm<br>λ <sub>P</sub> | Description                      |
|-------------|----------------|-------------------|--|-------|------------------------------------|----------------------------------|
|             |                |                   | min.   | typ.  |                                    |                                  |
| DMR14C-1    | Red            | GaAlAs            | 4700   | 23990 | 660                                | Common Cathode. Rt. Hand Decimal |

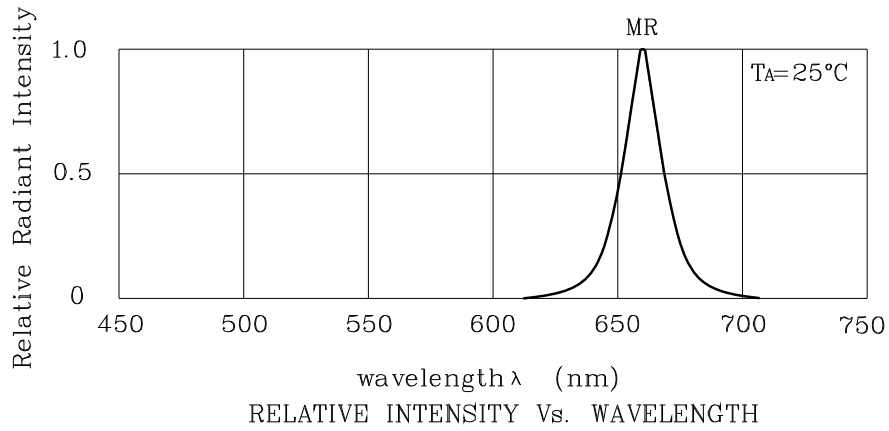

❖ MR

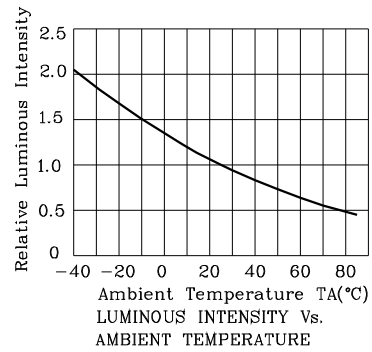
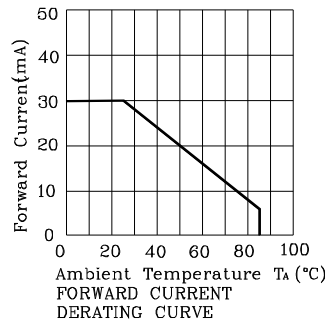
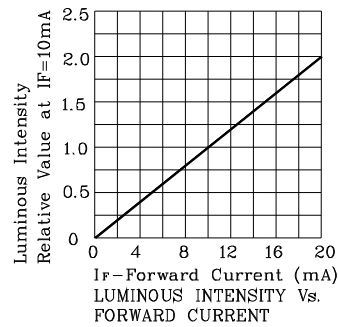
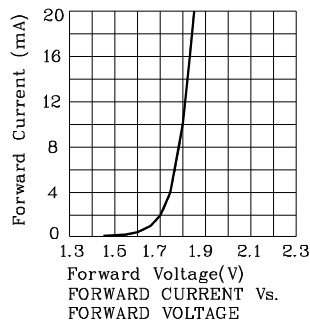

Wave Soldering Profile For Lead-free Through-hole LED.

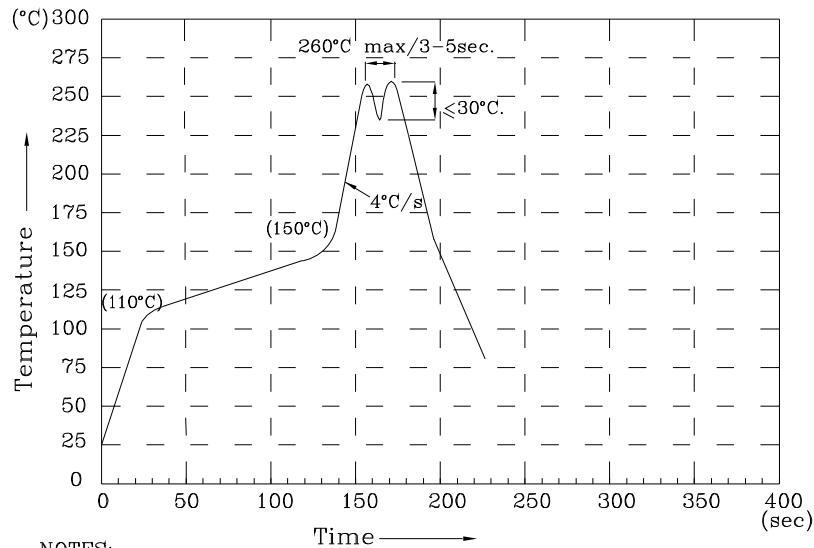

NOTES:

- 1.Recommend the wave temperature 245°C~260°C.The maximum soldering temperature should be less than 260°C.
- 2.Do not apply stress on epoxy resins when temperature is over 85 degree°C.
- 3.The soldering profile apply to the lead free soldering (Sn/Cu/Ag alloy).
- 4.No more than once.

Remarks:

If special sorting is required (e.g. binning based on forward voltage, luminous intensity/ luminous flux or wavelength), the typical accuracy of the sorting process is as follows:

1. Wavelength: +/-1nm
2. Luminous Intensity/ luminous flux: +/-15%
3. Forward Voltage: +/-0.1V

Note: Accuracy may depend on the sorting parameters.

**PACKING & LABEL SPECIFICATIONS**

**DMR14C-1**

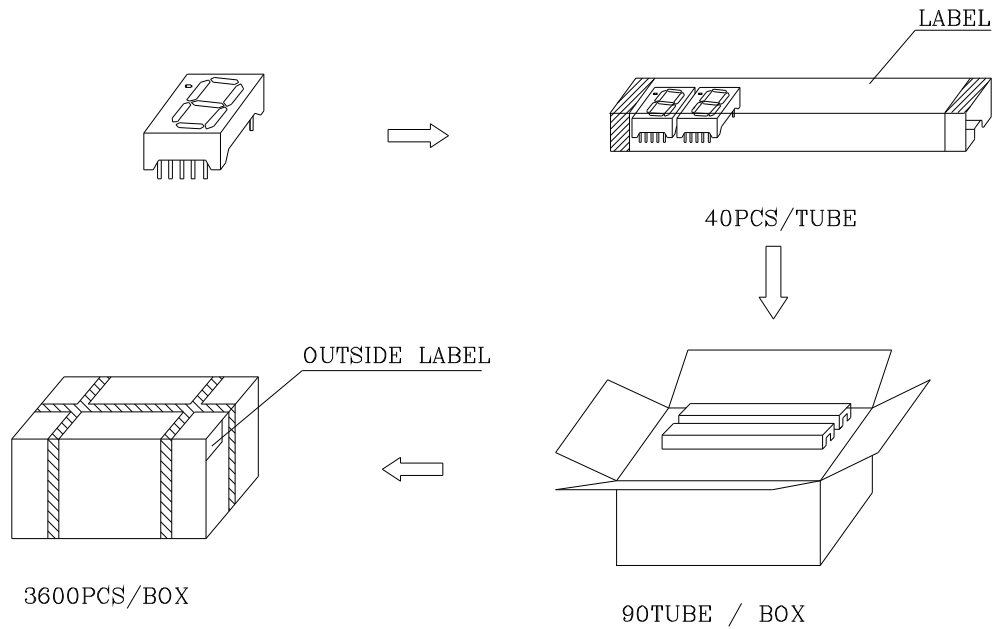

Inside LABEL Paste On The IC-tube

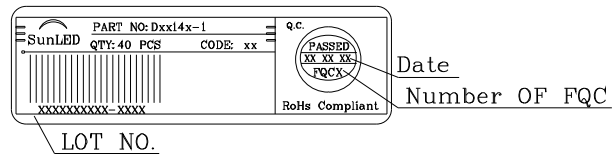

Outside LABEL Paste On The Box

