

## Standard Variable Output LDO Regulator Series

# Standard Variable Output LDO Regulators



**BA00DD0WCP-V5, BA00DD0WHFP, BA00DD0WT,  
BA00CC0WT, BA00CC0WT-V5, BA00CC0WCP-V5, BA00CC0WFP**

No.10023EBT01

## ●Description

The BA00DD0/CC0 series are low-saturation regulators available for outputs up to 2A/1A. The output voltage can be arbitrarily configured using the external resistance. These series of LDO regulators are offered in a broad packaging lineup. This IC has a built-in over-current protection circuit that prevents the destruction of the IC due to output short circuits and a thermal shutdown circuit that protects the IC from thermal damage due to overloading.

## ●Features

- 1) Maximum output current: 2A (BA00DD0 series), 1A(BA00CC0 series)
- 2)  $\pm 1\%$  high-precision output voltage (BA00DD0)
- 3) Low saturation with PNP output
- 4) Built-in over-current protection circuit that prevents the destruction of the IC due to output short circuits
- 5) Built-in thermal shutdown circuit for protecting the IC from thermal damage due to overloading
- 6) Built-in over-voltage protection circuit that prevents the destruction of the IC due to power supply surges
- 7) TO220FP and HRP5 packaging (BA00DD0), and TO220FP and TO252 packaging (BA00CC0)

## ●Applications

Usable in DSP power supplies for DVDs and CDs, FPDs, televisions, personal computers or any other consumer device

## ●Line up

### 1A BA00CC0 Series

Part Number	Package
BA00CC0WT	TO220FP-5
BA00CC0WT-V5	TO220FP-5(V5)
BA00CC0WCP-V5	TO220CP-V5
BA00CC0WFP	TO252-5

### 2A BA00DD0 Series

Part Number	Package
BA00DD0WT	TO220FP-5
BA00DD0WCP-V5	TO220CP-V5
BA00DD0WHFP	HRP5

●ABSOLUTE MAXIMUM RATINGS(Ta=25°C)

Parameter	Symbol	Limits	Unit
Input Power Supply Voltage <sup>*1</sup>	Vcc	-0.3 ~ +35	V
Power Dissipation	Pd	2300(HRP5)	mW
		1300(TO252-5)	
		2000(TO220FP-5)	
Operating Temperature Range	Topr	-40 ~ +125	°C
Ambient Storage Temperature	Tstg	-55 ~ +150	°C
Junction Temperature	Tjmax	+150	°C
Output Control Terminal Voltage	VCTL	-0.3 ~ +Vcc	V
Voltage Applied to the Tip <sup>*3</sup>	Vcc peak	+50	V

\*1 Must not exceed Pd

\*2 HRP5 : In cases in which Ta≥25°C when a 70mm×70mm×1.6mm glass epoxy board is used, the power is reduced by 18.4 mW/°C.  
TO252-5 : In cases in which Ta≥25°C when a 70mm×70mm×1.6mm glass epoxy board is used, the power is reduced by 10.4 mW/°C.  
TO252FP-5 : No heat sink. When Ta≥25°C, the power is reduced by 16 mW/°C.

\*3 Applied voltage: 200msec or less (tr≥1msec)

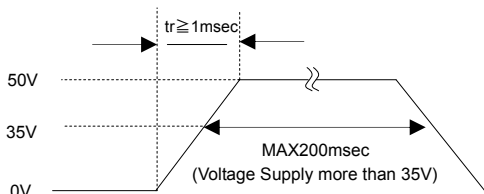

●Recommended Operating Range (Ta=25°C)

Parameter	Symbol	Min.	Max.	Unit
Input PowerSupply Voltage	BA00CC0□□	4.0	25.0	V
	BA00DD0□□	3.0	25.0	
Output Current	BA00CC0□□	—	1	A
	BA00DD0□□	—	2	
Output Control Terminal Voltage	VCTL	0	Vcc	V

●Electrical Characteristics(ABRIDGED)

BA00CC0□□ Series (unless specified otherwise, Ta=25°C, Vcc=10V, VCTL=5V, Io=500mA, R1=2.2kΩ, R2=6.8kΩ)

Parameter	Symbol	Min.	Typ.	Max.	Unit	Conditions
C-terminal Voltage	Vc	1.200	1.225	1.250	V	Io=50mA
Circuit Current at the Time of Shutdown	I <sub>sd</sub>	—	0	10	μA	VCTL=0V
Minimum I/O Voltage Difference	ΔVd	—	0.3	0.5	V	Vcc= 0.95 × Vo
Output Current Capacity	Io	1.0	—	—	A	
Input Stability	Reg.I	—	20	100	mV	Vcc= 6V→25 V
Load Stability	Reg.L	—	50	150	mV	Io=5mA→1A
Output Voltage Temperature Coefficient <sup>*</sup>	Tcvo	—	±0.02	—	%/°C	Io=5mA, Tj=0~125°C

\*Design guarantee (100% shipping inspection not performed)

BA00DD0□□ Series (unless specified otherwise, Ta=25°C, Vcc=8V, VCTL=3V, Io=500mA, R1=15kΩ, R2=44kΩ)

Parameter	Symbol	Min.	Typ.	Max.	Unit	Conditions
C-terminal Voltage	V <sub>ADJ</sub>	1.257	1.270	1.283	V	Io=100mA
Circuit Current at the Time of Shutdown	I <sub>sd</sub>	—	0	10	μA	VCTL=0V
Minimum I/O Voltage Difference	ΔVd	—	0.45	0.7	V	Vcc= 0.95 × Vo, Io=2A
Output Current Capacity	Io	2.0	—	—	A	
Input Stability	Reg.I	—	15	35	mV	Vcc= 5.7V→25 V, Io=200mA
Load Stability	Reg.L	—	50	100	mV	Io=0mA→2A
Output Voltage Temperature Coefficient <sup>*</sup>	Tcvo	—	±0.02	—	%/°C	Io=5mA, Tj=0~125°C

\*Design guarantee (100% shipping inspection not performed)

●Reference Data BA00CC0□□(3.3V preset voltage)

(Unless specified otherwise,  $V_{CC}=10V$ ,  $V_{OUT}=3.3V$  preset,  $V_{CTL}=3V$ ,  $I_o=0mA$ ,  $R_1=2.2k\Omega$ , and  $R_2=6.8k\Omega$ )

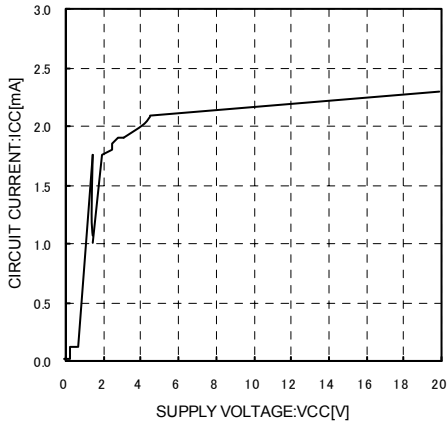

Fig.1 Circuit current

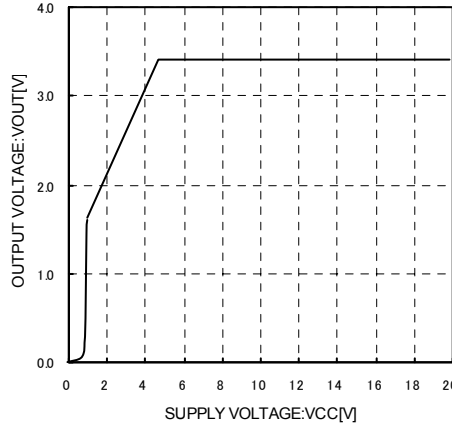

Fig.2 Input Stability

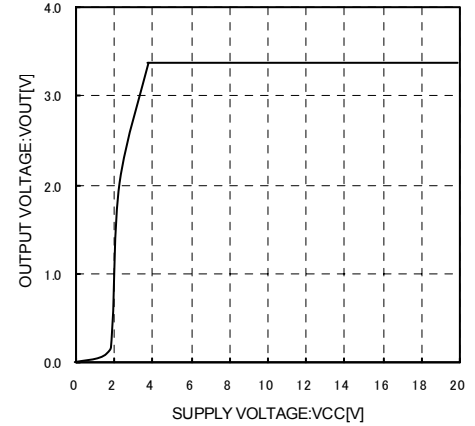

Fig.3 Input Stability  
( $I_o=500mA$ )

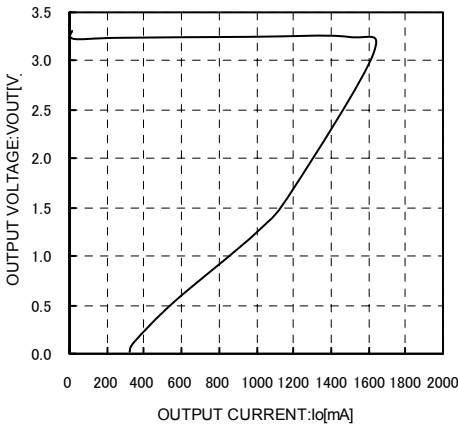

Fig.4 Load Stability

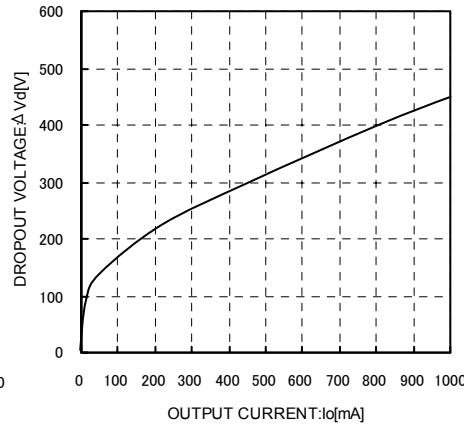

Fig.5 Input/Output Voltage Difference  
 $I_o-\Delta V_d$  Characteristics ( $V_{CC}=2.95V$ )

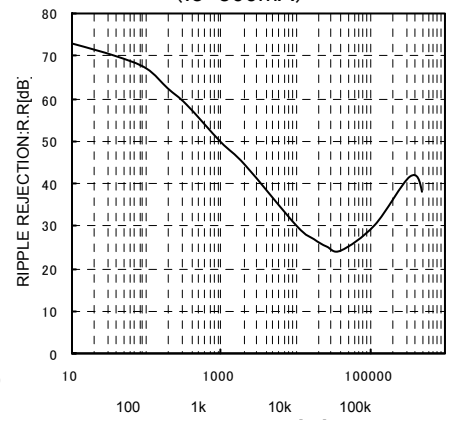

Fig.6 Ripple Rejection Characteristics  
( $I_o=100mA$ )

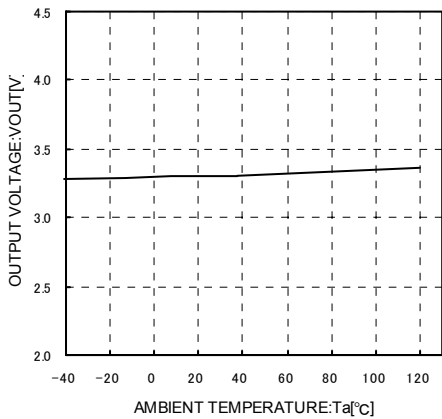

Fig.7 Output Voltage  
Temperature Characteristics

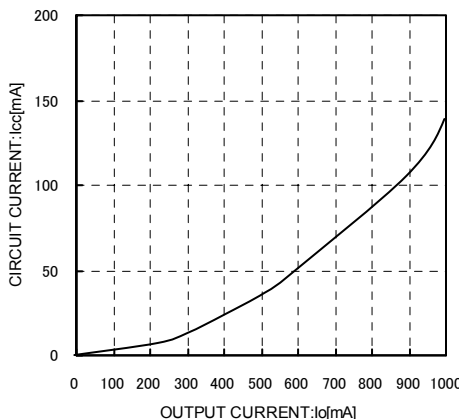

Fig.8 Circuit Current by load Level  
( $I_{OUT}=0mA \rightarrow 1A$ )

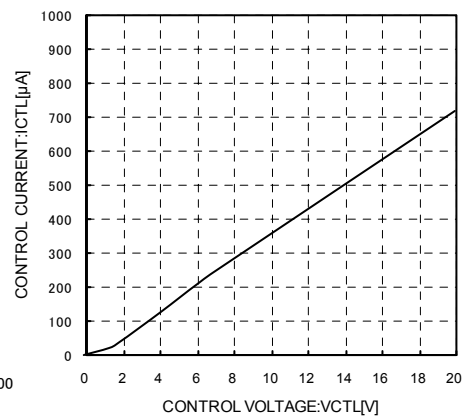

Fig.9 CTL Voltage vs. CTL Current

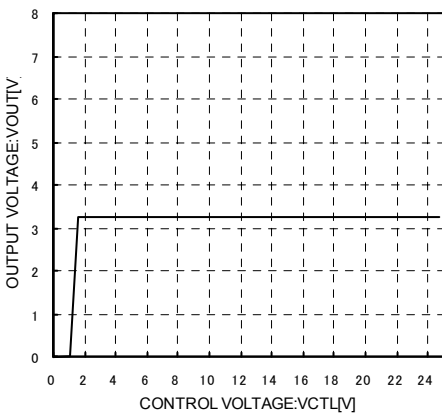

Fig.10 CTL Voltage vs. Output Voltage

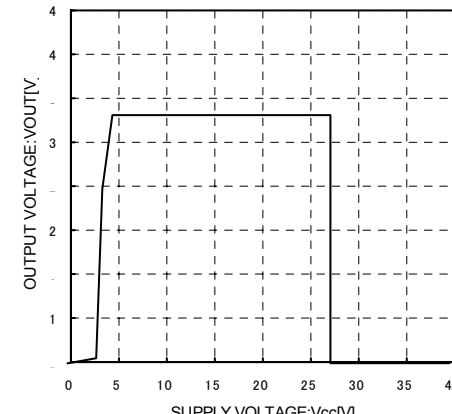

Fig.11 Overvoltage Operating  
Characteristics ( $I_o=200mA$ )

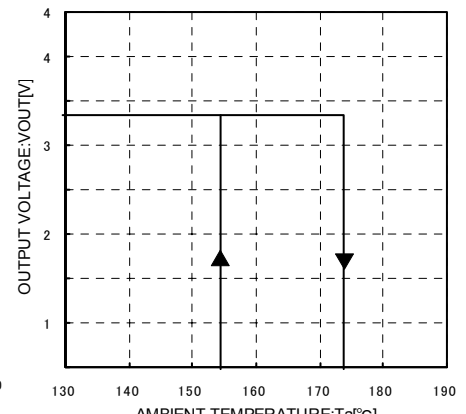

Fig.12 Thermal Shutdown  
Circuit Characteristics

●Reference Data BA00DD0□□(5.0V preset voltage)

(Unless specified otherwise, Vcc=8V, VOUT=5V preset, VCTL=3V, Io=0mA, R1=15kΩ, and R2=44kΩ)

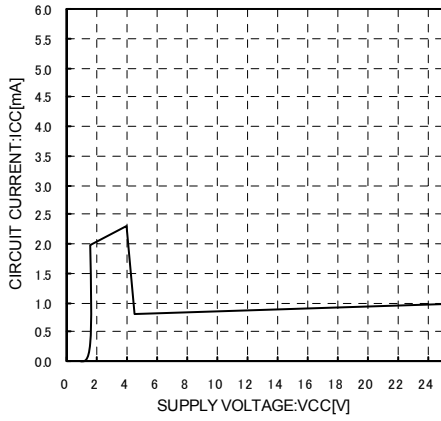

Fig.13 Circuit Current

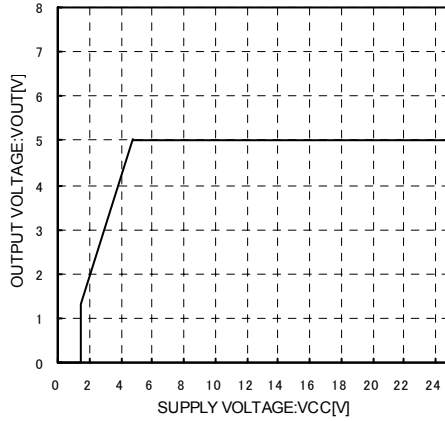

Fig.14 Input Stability

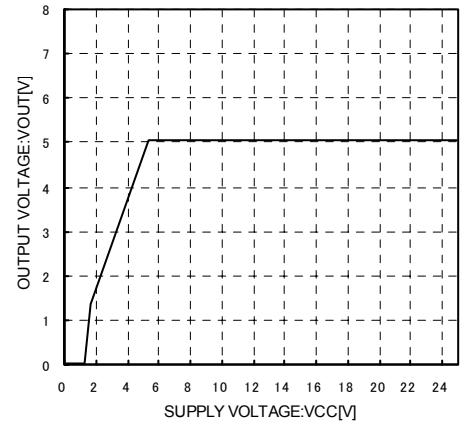

Fig.15 Input Stability (Io=2A)

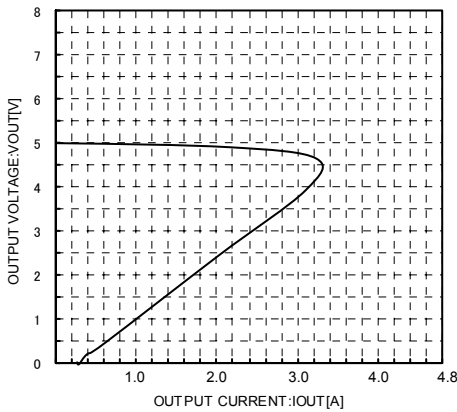

Fig.16 Load Stability

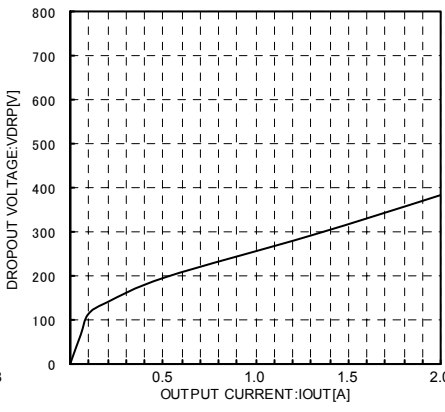

Fig.17 Input/Output Voltage Difference Iout-ΔVd Characteristics (Vcc=4.75V)

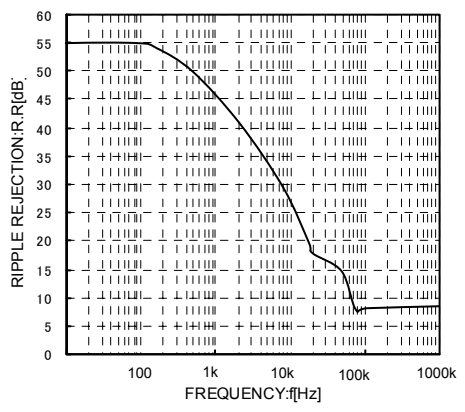

Fig.18 Ripple Rejection Characteristics (Iout=100mA)

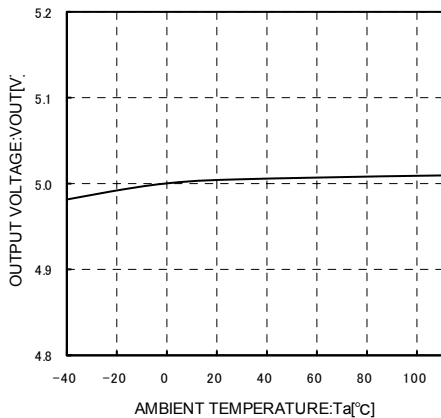

Fig.19 Output Voltage Temperature Characteristics

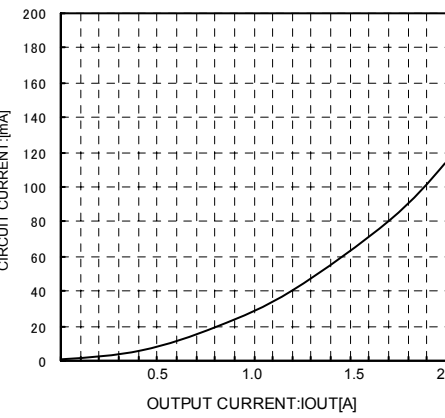

Fig.20 Circuit Current by load Level (IOUT=0mA→2A)

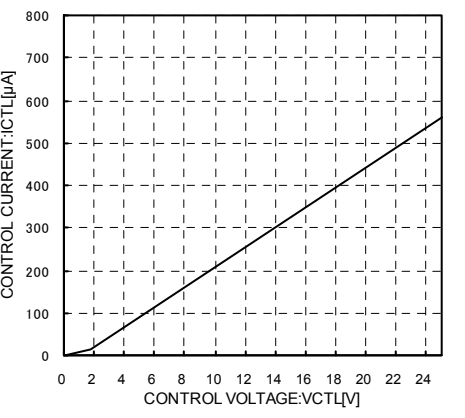

Fig.21 CTL Voltage vs. CTL Current

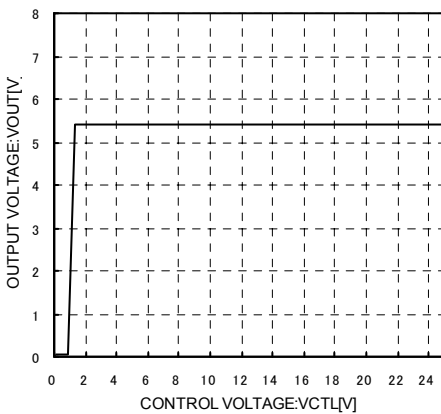

Fig.10 CTL Voltage vs. Output Voltage

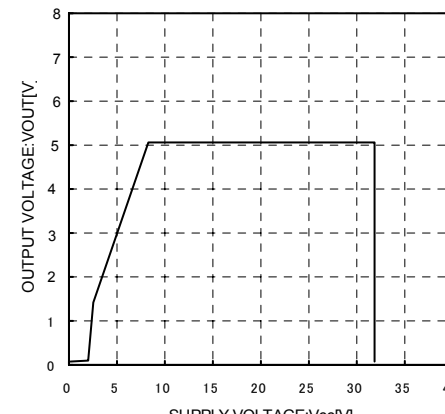

Fig.11 Overvoltage Operating Characteristics (Io=200mA)

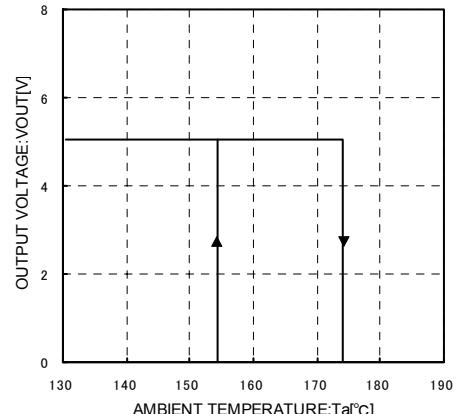
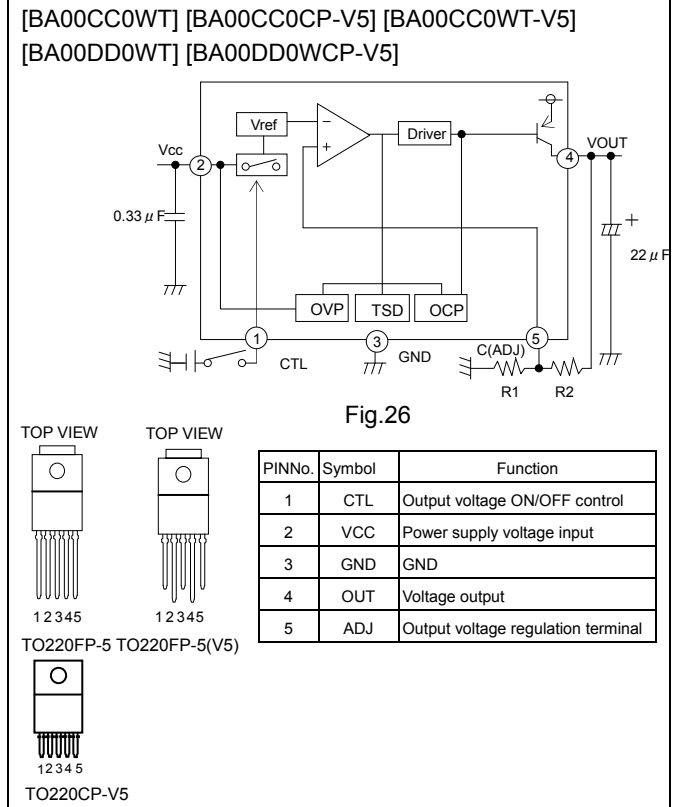
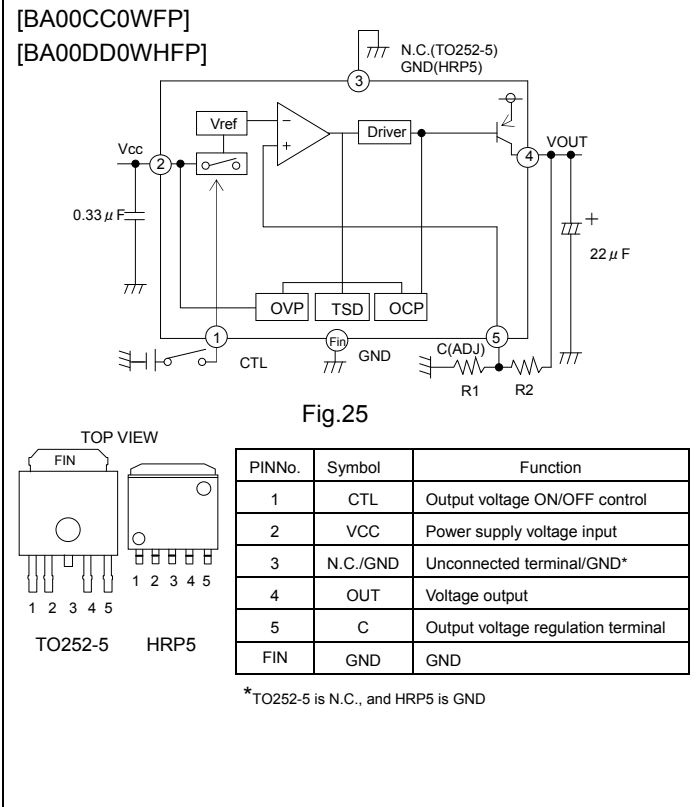
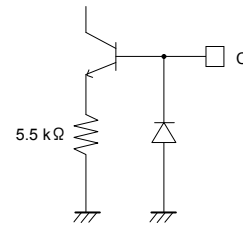
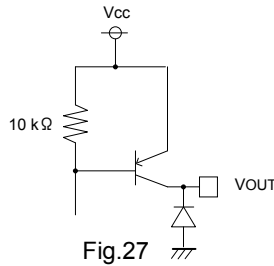
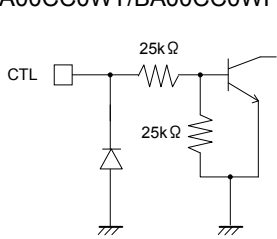

Fig.12 Thermal Shutdown Circuit Characteristics

●Block Diagrams



●Input / Output Equivalent Circuit Diagrams  
< BA00CC0WT/BA00CC0WFP >



< BA00DD0WT/BA00DD0WFP >

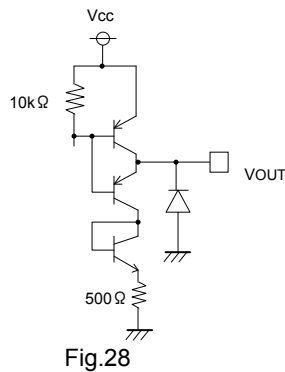
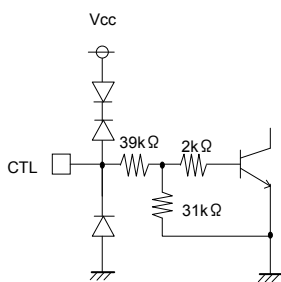

●Output Voltage Configuration Method

Please connect resistors R1 and R2 (which determines the output voltage) as shown in Fig.29. Please be aware that the offset due to the current that flows from the ADJ terminal becomes large when resistors with large values are used. The use of resistors with R1=2kΩ to 15 kΩ is recommended.

$$V_o = V_c (V_{ADJ}) \times \left( 1 + \frac{R_2}{R_1} \right)$$

BA□□CC0□□      Vc : 1.225 (Typ.)  
BA□□DD0□□      VADJ : 1.270 (Typ.)

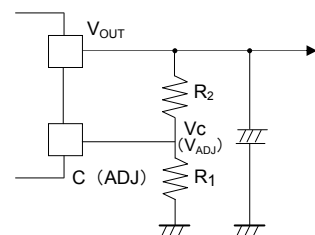

Fig.29

● Thermal Design

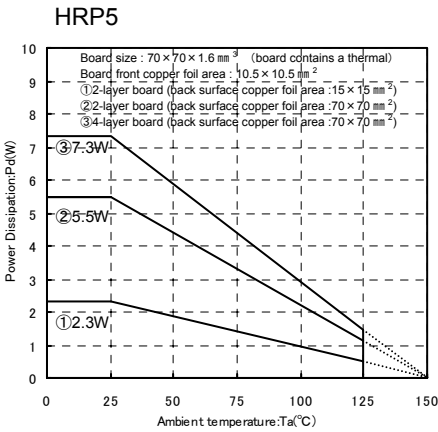

Fig.30

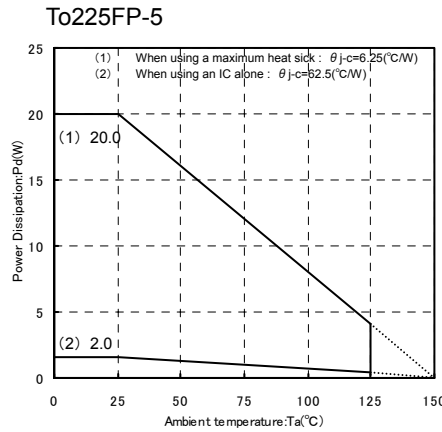

Fig.31

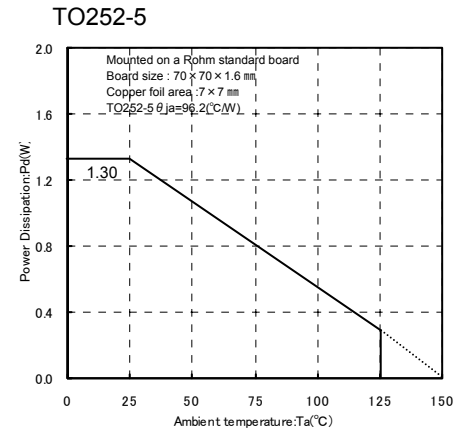

Fig.32

When using at temperatures over Ta=25°C, please refer to the heat reducing characteristics shown in Fig.30 through 32. The IC characteristics are closely related to the temperature at which the IC is used, so it is necessary to operate the IC at temperatures less than the maximum junction temperature TjMAX.

Fig.31 shows the acceptable loss and heat reducing characteristics of the TO220FP package. The portion shown by the diagonal line is the acceptable loss range that can be used with the IC alone. Even when the ambient temperature Ta is a normal temperature (25°C), the chip (junction) temperature Tj may be quite high so please operate the IC at temperatures less than the acceptable loss Pd.

The calculation method for power consumption Pc(W) is as follows :

Vcc : Input voltage  
Vo : Output voltage  
Io : Load current  
Icca : Circuit current

$$Pc = (Vcc - Vo) \times Io + Vcc \times Icca$$

$$\text{Acceptable loss } Pd \leq Pc$$

Solving this for load current IO in order to operate within the acceptable loss,

$$Io \leq \frac{Pd - Vcc \times Icca}{Vcc - Vo}$$

(Please refer to Figs.8 and 20 for Icca.)

It is then possible to find the maximum load current IOMAX with respect to the applied voltage Vcc at the time of thermal design.

Calculation Example

Example 1) When Ta=85°C, Vcc=8.3V, Vo=3.3V, BA33DD0WT

$$Io \leq \frac{1.04 - 8.3 \times Icca}{5}$$

$$Io \leq 200\text{mA} \text{ (Icca : 2mA)}$$

With the IC alone :  $\theta_{ja} = 62.5^\circ\text{C/W} \rightarrow -16\text{mW}/^\circ\text{C}$   
 $25^\circ\text{C} = 2000\text{mW} \rightarrow 85^\circ\text{C} = 1040\text{mW}$

Please refer to the above information and keep thermal designs within the scope of acceptable loss for all operating temperature ranges. The power consumption Pc of the IC when there is a short circuit (short between Vo and GND) is :

$$Pc = Vcc \times (Icca + I_{short})$$

Ishort : Short circuit current

● Terminal Vicinity Settings and Cautions

- Vcc Terminal

Please attach a capacitor (greater than 0.33 μF) between the Vcc and GND.

The capacitance values differ depending on the application, so please chose a capacitor with sufficient margin and verify the operation on an actual board.

- CTL Terminal

The CTL terminal is turned ON at 2.0V and higher and OFF at 0.8V and lower within the operating power supply voltage range. The power supply and the CTL terminal may be started up and shut down in any order without problems.

●Vo Terminal

Please attach an anti-oscillation capacitor between V<sub>OUT</sub> and GND. The capacitance of the capacitor may significantly change due to factors such as temperature changes, which may cause oscillations. Please use a tantalum capacitor or aluminum electrolytic capacitor with favorable characteristics and small external series resistance (ESR) even at low temperatures. The output oscillates regardless of whether the ESR is large or small. Please use the IC within the stable operating region while referring to the ESR characteristics reference data shown in Figs.33 through 35. In cases where there are sudden load fluctuations, the a large capacitor is recommended.

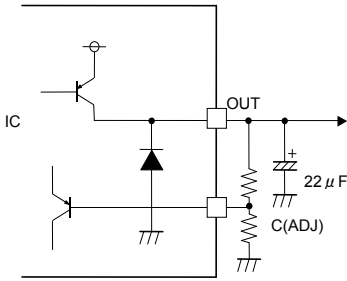

Fig.33:Output equivalent circuit

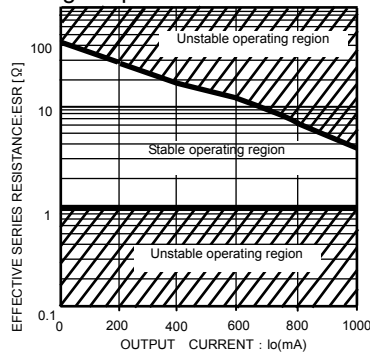

Fig.34: I<sub>o</sub> vs. ESR characteristics (BA□□CC0)

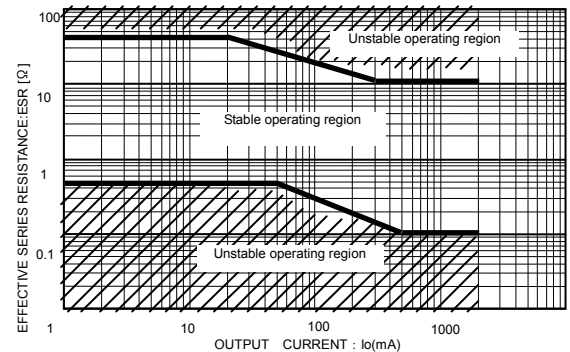

Fig.35: I<sub>o</sub> vs. ESR characteristics (BA□□DD0)

●Other

1) Protection Circuits

Overcurrent Protection Circuit

A built-in overcurrent protection circuit corresponding to the current capacity prevents the destruction of the IC when there are load shorts. This protection circuit is a “7”-shaped current control circuit that is designed such that the current is restricted and does not latch even when a large current momentarily flows through the system with a high-capacitance capacitor. However, while this protection circuit is effective for the prevention of destruction due to unexpected accidents, it is not suitable for continuous operation or transient use. Please be aware when creating thermal designs that the overcurrent protection circuit has negative current capacity characteristics with regard to temperature (Refer to Figs.4 and 16).

Thermal Shutdown Circuit (Thermal Protection)

This system has a built-in temperature protection circuit for the purpose of protecting the IC from thermal damage. As shown above, this must be used within the range of acceptable loss, but if the acceptable loss happens to be continuously exceeded, the chip temperature T<sub>j</sub> increases, causing the temperature protection circuit to operate.

When the thermal shutdown circuit operates, the operation of the circuit is suspended. The circuit resumes operation immediately after the chip temperature T<sub>j</sub> decreases, so the output repeats the ON and OFF states (Please refer to Figs.12 and 24 for the temperatures at which the temperature protection circuit operates).

There are cases in which the IC is destroyed due to thermal runaway when it is left in the overloaded state. Be sure to avoid leaving the IC in the overloaded state.

Reverse Current

In order to prevent the destruction of the IC when a reverse current flows through the IC, it is recommended that a diode be placed between the V<sub>CC</sub> and V<sub>O</sub> and a pathway be created so that the current can escape (Refer to Fig.36).

2) This IC is bipolar IC that has a P-board (substrate) and P+ isolation layer between each device, as shown in Fig.37. A P-N junction is formed between this P-layer and the N-layer of each device, and the P-N junction operates as a parasitic diode when the electric potential relationship is GND > Terminal A, GND > Terminal B, while it operates as a parasitic transistor when the electric potential relationship is Terminal B > Terminal A. Parasitic devices are intrinsic to the IC. The operation of parasitic devices induces mutual interference between circuits, causing malfunctions and eventually the destruction of the IC itself. It is necessary to be careful not to use the IC in ways that would cause parasitic elements to operate. For example, applying a voltage that is lower than the GND (P-board) to the input terminal.

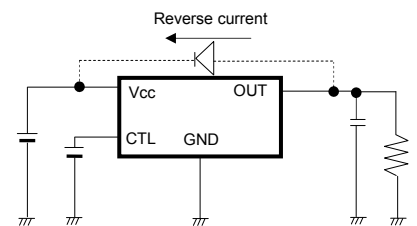

Fig. 36: Bypass diode

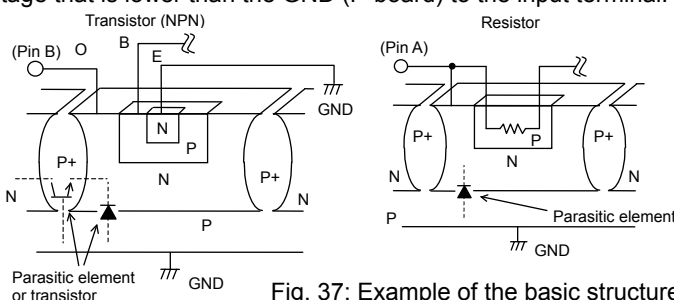
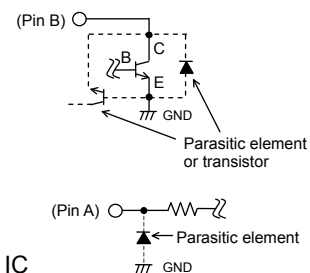

Fig. 37: Example of the basic structure of a bipolar IC



●Ordering part number

B	A	0	0	C	C	0	W	H	F	P	-	T	R
Part No.		Output voltage 00:Variable		Series CC0 : 1A DD0 : 2A			Shutdown switch W : Includes switch	Package HFP : HRP5 FP : TO252 CP : TO220CP T : TO220FP			Packaging and forming specification TR: Embossed tape and reel (HRP5) E2: Embossed tape and reel (TO252-5,TO220CP) None : Container Tube V5 :Foaming(V5 only)		

HRP5

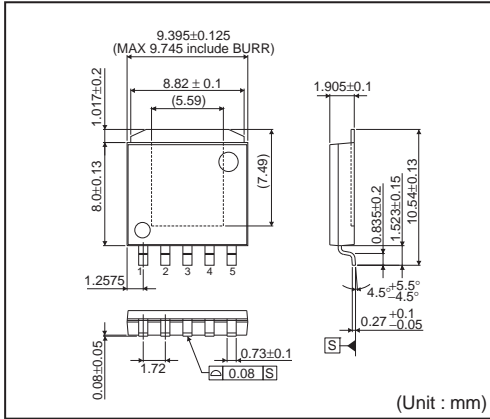

<Tape and Reel information>

Tape	Embossed carrier tape
Quantity	2000pcs
Direction of feed	TR ( The direction is the 1pin of product is at the upper right when you hold reel on the left hand and you pull out the tape on the right hand )

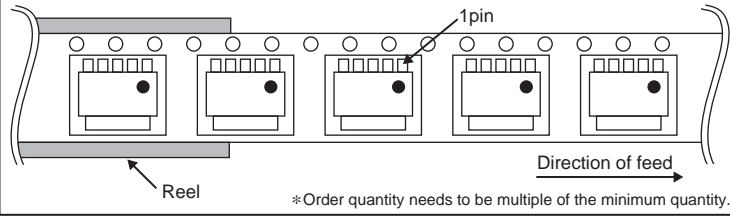

TO252-5

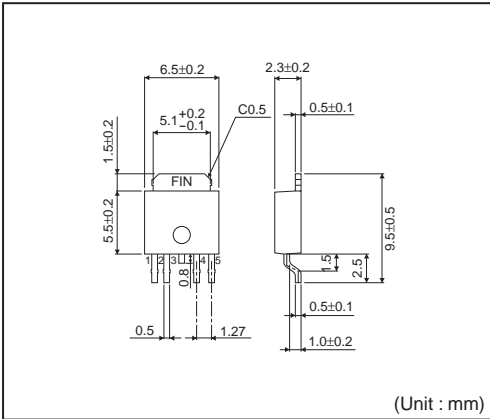

<Tape and Reel information>

Tape	Embossed carrier tape
Quantity	2000pcs
Direction of feed	E2 ( The direction is the 1pin of product is at the lower left when you hold reel on the left hand and you pull out the tape on the right hand )

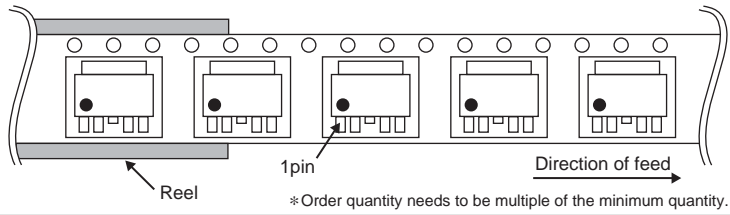

TO220CP-V5

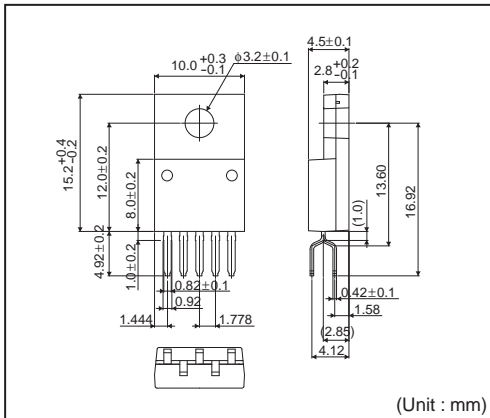

<Tape and Reel information>

Tape	Embossed carrier tape
Quantity	500pcs
Direction of feed	E2 ( The direction is the 1pin of product is at the lower left when you hold reel on the left hand and you pull out the tape on the right hand )

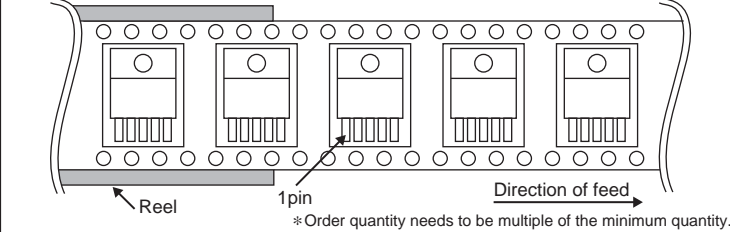



**TO220FP-5**

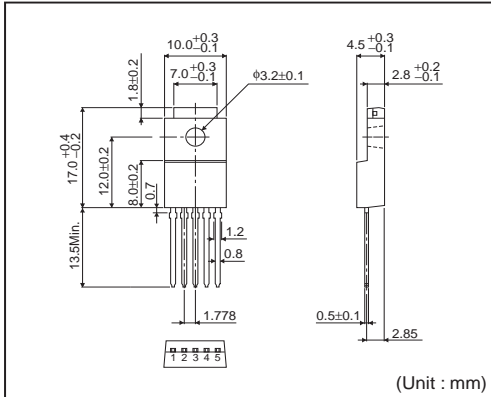

<Tape and Reel information>

Container	Tube
Quantity	500pcs
Direction of feed	Direction of products is fixed in a container tube

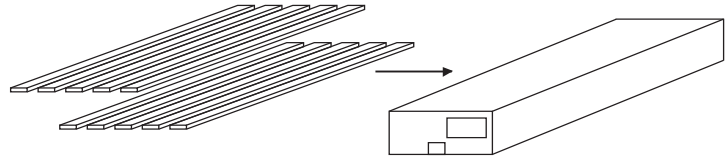

\*Order quantity needs to be multiple of the minimum quantity.

**TO220FP-5(V5)**

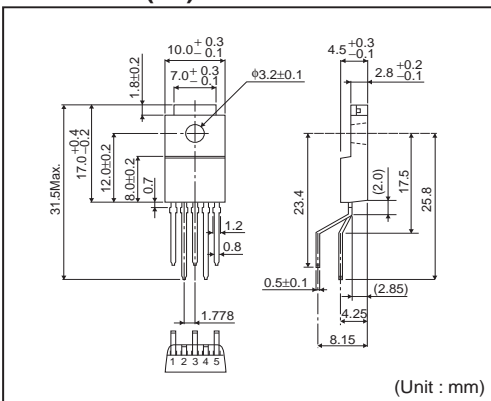

<Tape and Reel information>

Container	Tube
Quantity	500pcs
Direction of feed	Direction of products is fixed in a container tube

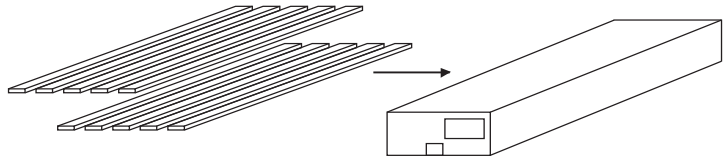

\*Order quantity needs to be multiple of the minimum quantity.

## Notes

No copying or reproduction of this document, in part or in whole, is permitted without the consent of ROHM Co.,Ltd.

The content specified herein is subject to change for improvement without notice.

The content specified herein is for the purpose of introducing ROHM's products (hereinafter "Products"). If you wish to use any such Product, please be sure to refer to the specifications, which can be obtained from ROHM upon request.

Examples of application circuits, circuit constants and any other information contained herein illustrate the standard usage and operations of the Products. The peripheral conditions must be taken into account when designing circuits for mass production.

Great care was taken in ensuring the accuracy of the information specified in this document. However, should you incur any damage arising from any inaccuracy or misprint of such information, ROHM shall bear no responsibility for such damage.

The technical information specified herein is intended only to show the typical functions of and examples of application circuits for the Products. ROHM does not grant you, explicitly or implicitly, any license to use or exercise intellectual property or other rights held by ROHM and other parties. ROHM shall bear no responsibility whatsoever for any dispute arising from the use of such technical information.

The Products specified in this document are intended to be used with general-use electronic equipment or devices (such as audio visual equipment, office-automation equipment, communication devices, electronic appliances and amusement devices).

The Products specified in this document are not designed to be radiation tolerant.

While ROHM always makes efforts to enhance the quality and reliability of its Products, a Product may fail or malfunction for a variety of reasons.

Please be sure to implement in your equipment using the Products safety measures to guard against the possibility of physical injury, fire or any other damage caused in the event of the failure of any Product, such as derating, redundancy, fire control and fail-safe designs. ROHM shall bear no responsibility whatsoever for your use of any Product outside of the prescribed scope or not in accordance with the instruction manual.

The Products are not designed or manufactured to be used with any equipment, device or system which requires an extremely high level of reliability the failure or malfunction of which may result in a direct threat to human life or create a risk of human injury (such as a medical instrument, transportation equipment, aerospace machinery, nuclear-reactor controller, fuel-controller or other safety device). ROHM shall bear no responsibility in any way for use of any of the Products for the above special purposes. If a Product is intended to be used for any such special purpose, please contact a ROHM sales representative before purchasing.

If you intend to export or ship overseas any Product or technology specified herein that may be controlled under the Foreign Exchange and the Foreign Trade Law, you will be required to obtain a license or permit under the Law.



Thank you for your accessing to ROHM product informations.  
More detail product informations and catalogs are available, please contact us.

## ROHM Customer Support System

<http://www.rohm.com/contact/>