

features

- Superior to RK73 series in maximum working voltage
- Suitable for flow and reflow solderings
- Marking: White three-digit on black protective coat
1J: no marking
- Products with lead-free terminations meet EU RoHS requirements. Pb located in glass material, electrode and resistor element is exempt per Annex 1, exemption 5 of EU directive 2005/95/EC

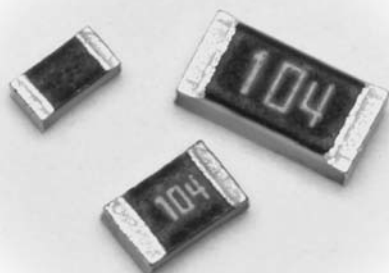

dimensions and construction

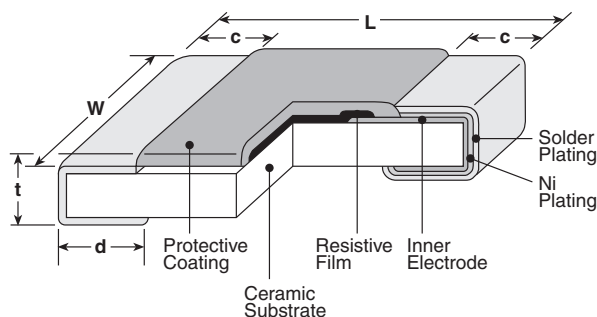

Type (Inch Size Code)	Dimensions inches (mm)				
	L	W	c	d	t
1J (0603)	.063±.008 (1.6±0.2)	.031±.004 (0.8±0.1)	.012±.004 (0.3±0.1)	.012±.004 (0.3±0.1)	.018±.004 (0.45±0.1)
2A (0805)	.079±.008 (2.0±0.2)	.049±.004 (1.25±0.1)	.016±.008 (0.4±0.2)	.012 ^{+0.008} _{-.004} (0.3 ^{+0.2} _{-.1})	.02±.004 (0.5±0.1)
2B (1206)	.126±.008 (3.2±0.2)	.063±.008 (1.6±0.2)	.02±.012 (0.5±0.3)	.016 ^{+0.008} _{-.004} (0.4 ^{+0.2} _{-.1})	.024±.004 (0.6±0.1)
2H (2010)	.197±.008 (5.0±0.2)	.098±.008 (2.5±0.2)	.02±.012 (0.5±0.3)	.016 ^{+0.008} _{-.004} (0.4 ^{+0.2} _{-.1})	.024±.004 (0.6±0.1)
3A (2512)	.248±.008 (6.3±0.2)	.122±.008 (3.1±0.2)	.02±.012 (0.5±0.3)	.016 ^{+0.008} _{-.004} (0.4 ^{+0.2} _{-.1})	.024±.004 (0.6±0.1)

ordering information

New Part #	HV73	2B	T	TD	1004	F
Type						
Size		1J: 0.1W 2A: 0.125W 2B: 0.25W 2H: 0.5W 3A: 1W				
Termination Material			T: Sn			
Packaging				TD: 0603, 0805, 1206: 7" 2mm pitch punched paper TDD: 0603, 0805, 1206: 10" paper tape TE: 2010 & 2512: 7" punched plastic TED: 2010 & 2512: 10" punched plastic For further information on packaging, please refer to Appendix A		
Nominal Resistance					±0.5%, ±1%: 3 significant figures + 1 multiplier ±2%, ±5%: 2 significant figures + 1 multiplier	
Resistance Tolerance						D: ±0.5% F: ±1% G: ±2% J: ±5%

applications and ratings

Part Designation	Power Rating @ 70°C	T.C.R. (ppm/°C) Max.	Resistance Range				Absolute Maximum Working Voltage	Maximum Overload Voltage (D.C.)*	Operating Temperature Range
			E-24 (D±0.5%)	E-24 (F±1%)	E-24 (G±2%)	E-24 (J±5%)			
1J	0.1W	±100**	—	10k - 10M	10k - 10M	10k - 10M	350V	500V*	-55°C to +155°C
2A	0.125W	±100	100k - 1M	100k - 10M	100k - 10M	100k - 10M	400V	800V*	
		±200	—	—	—	11M - 51M			
2B	0.25W	±100	100k - 1M	100k - 10M	100k - 10M	100k - 10M	500V	1000V*	
		±200	—	—	—	11M - 51M			
2H	0.5W	±100	100k - 1M	100k - 10M	100k - 10M	100k - 10M	2000V(*D.C.)	3000V*	
		±200	—	—	—	11M - 51M			
3A	1W	±100	43k - 1M	43k - 10M	43k - 10M	43k - 10M	3000V(*D.C.)	4000V*	
		±200	—	11M - 20M	11M - 20M	11M - 51M			

* AC Voltage Reference: When using for A.C. Voltage, use the peak A.C. Voltage, which should not exceed the Maximum DC Overload Voltage (Max. DC Voltage/√2)

** Cold T.C.R. of 1.1MΩ ~ 10MΩ is +200x10⁻⁶/K

environmental applications

Derating Curve

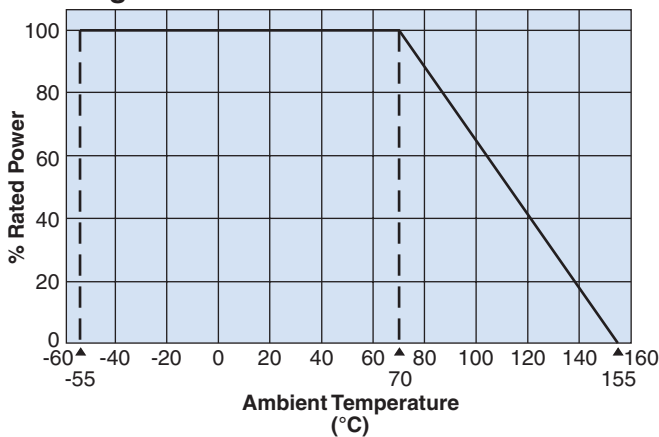

Performance Characteristics

Parameter	Requirement Δ R		Test Method
	Limit	Typical	
Resistance	Within regulated tolerance	—	25°C
T.C.R.	Within specified T.C.R.	—	+25°C/-55°C and +25°C/+125°C
Overload (Short time)	±2%	±0.5%	Rated Voltage (D.C.) x 2.5 for 5 seconds
Resistance to Solder Heat	±1%	±0.5%	260°C ± 5°C, 10 seconds ± 1 second
Rapid Change of Temperature	±0.5%, ±1%*	±0.3%, ±0.5%**	-55°C (30 minutes), +125°C (30 minutes), 100 cycles
Moisture Resistance	±2%	±0.75%	40°C ± 2°C, 90%-95% RH, 1000 hours, 1.5 hr ON, 0.5 hr OFF cycle
Endurance at 70°C	±2%	±0.75%	70°C ± 2°C, 1000 hours, 1.5 hr ON, 0.5 hr OFF cycle
High Temperature Exposure	±2%	±0.3%	+155°C, 1000 hours

* ±0.5%: (100kΩ≤R≤10MΩ), ±1%: (11MΩ≤R≤51MΩ)

** ±0.3%: (100kΩ≤R≤10MΩ), ±0.5%: (11MΩ≤R≤51MΩ)

Additional environmental applications can also be found at www.koaspeer.com

Specifications given herein may be changed at any time without prior notice. Please confirm technical specifications before you order and/or use.

11/07/08