



N-Channel Logic Level Enhancement Mode Field Effect Transistor

PRODUCT SUMMARY

V _{DSS}	I _D	R _{DS(ON)} (mΩ) Max
30V	30A	20 @ V _{GS} =10V
		29 @ V _{GS} =4.5V

FEATURES

- Super high dense cell design for low R_{DS(ON)}.
- Rugged and reliable.
- TO-252 and TO-251 Package.
- ESD Protected.

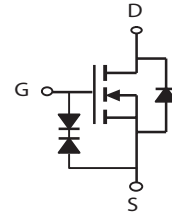
STU SERIES
TO-252AA(D-PAK)STD SERIES
TO-251(L-PAK)

ABSOLUTE MAXIMUM RATINGS (T_C=25°C unless otherwise noted)

Symbol	Parameter	Limit	Units
V _{DS}	Drain-Source Voltage	30	V
V _{GS}	Gate-Source Voltage	±20	V
I _D	Drain Current-Continuous ^a	T _C =25°C	30 ^e
		T _C =70°C	24
I _{DM}	-Pulsed ^b	120	A
E _{AS}	Avalanche Energy ^d	15	mJ
P _D	Maximum Power Dissipation ^a	T _C =25°C	32
		T _C =70°C	20
T _J , T _{STG}	Operating Junction and Storage Temperature Range	-55 to 150	°C

THERMAL CHARACTERISTICS

R _{θJC}	Thermal Resistance, Junction-to-Case ^a	4	°C/W
R _{θJA}	Thermal Resistance, Junction-to-Ambient ^a	50	°C/W

STU/D320S

Ver 1.0

ELECTRICAL CHARACTERISTICS (T_c=25°C unless otherwise noted)

Symbol	Parameter	Conditions	Min	Typ	Max	Units
OFF CHARACTERISTICS						
BV _{DSS}	Drain-Source Breakdown Voltage	V _{GS} =0V , I _D =250uA	30			V
I _{DSS}	Zero Gate Voltage Drain Current	V _{DS} =24V , V _{GS} =0V			1	A
I _{GSS}	Gate-Body leakage current	V _{GS} = ±20V , V _{DS} =0V			±10	uA
ON CHARACTERISTICS						
V _{GS(th)}	Gate Threshold Voltage	V _{DS} =V _{GS} , I _D =250uA	1	1.8	3	V
R _{DS(ON)}	Drain-Source On-State Resistance	V _{GS} =10V , I _D =15A		16	20	m ohm
		V _{GS} =4.5V , I _D =12.5A		22	29	m ohm
g _{FS}	Forward Transconductance	V _{DS} =10V , I _D =15A		12		S
DYNAMIC CHARACTERISTICS ^c						
C _{ISS}	Input Capacitance	V _{DS} =15V, V _{GS} =0V f=1.0MHz		430		pF
C _{OSS}	Output Capacitance			140		pF
C _{RSS}	Reverse Transfer Capacitance			88		pF
SWITCHING CHARACTERISTICS ^c						
t _{D(ON)}	Turn-On DelayTime	V _{DD} =15V I _D =1A V _{GS} =10V R _{GEN} =6 ohm		8		ns
t _r	Rise Time			13		ns
t _{D(OFF)}	Turn-Off DelayTime			16		ns
t _f	Fall Time			30		ns
Q _g	Total Gate Charge	V _{DS} =15V, I _D =15A, V _{GS} =10V		8		nC
		V _{DS} =15V, I _D =15A, V _{GS} =4.5V		4		nC
Q _{gs}	Gate-Source Charge	V _{DS} =15V, I _D =15A, V _{GS} =10V		0.9		nC
Q _{gd}	Gate-Drain Charge			2.5		nC
DRAIN-SOURCE DIODE CHARACTERISTICS AND MAXIMUM RATINGS						
I _S	Maximum Continuous Drain-Source Diode Forward Current				2.2	A
V _{SD}	Diode Forward Voltage ^b	V _{GS} =0V, I _S =2.2A		0.8	1.3	V
Notes a. Surface Mounted on FR4 Board, t _l ≤10 sec. b. Pulse Test: Pulse Width ≤ 300us, Duty Ctcle ≤ 2%. c. Guaranteed by design, not subject to production testing. d. Starting T _J =25°C, L=0.5mH, R _G =25Ω, V _{DD} =30V, V _{GS} =10V .(See Figure13) e. Package current limitation is 20A.						

Aug, 11, 2008

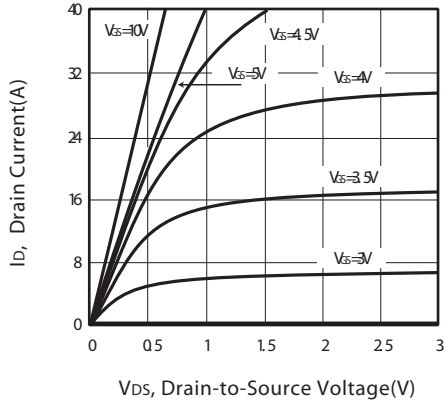

Figure 1. Output Characteristics

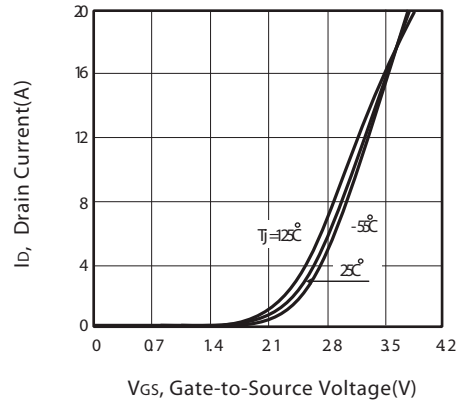

Figure 2. Transfer Characteristics

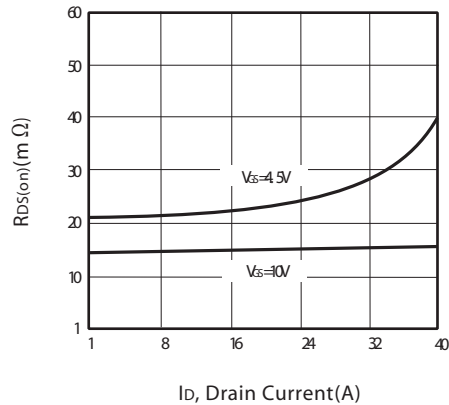

Figure 3. On-Resistance vs. Drain Current and Gate Voltage

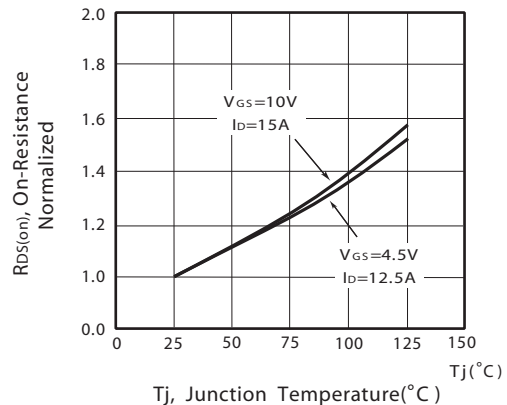

Figure 4. On-Resistance Variation with Drain Current and Temperature

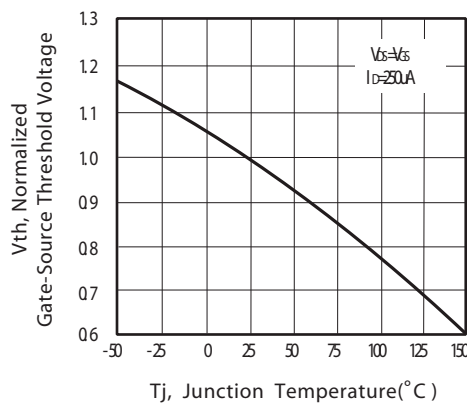

Figure 5. Gate Threshold Variation with Temperature

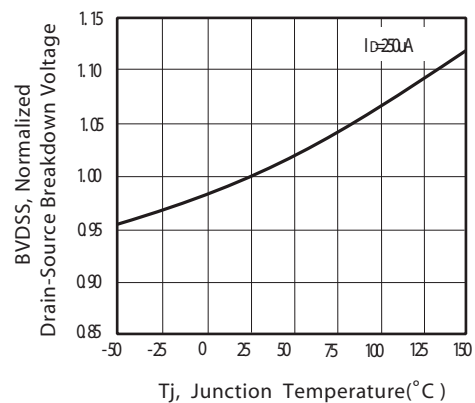

Figure 6. Breakdown Voltage Variation with Temperature

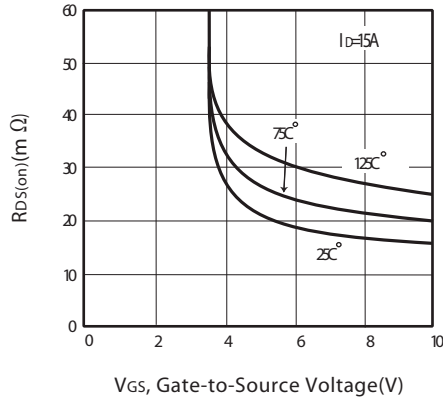

Figure 7. On-Resistance vs. Gate-Source Voltage

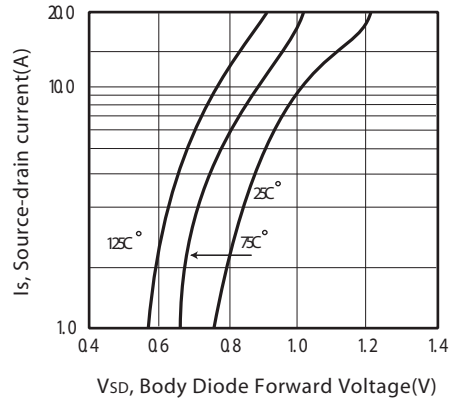

Figure 8. Body Diode Forward Voltage Variation with Source Current

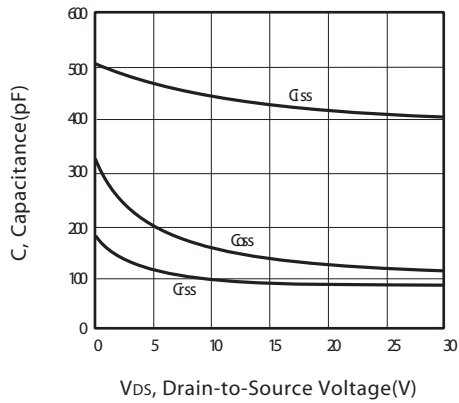

Figure 9. Capacitance

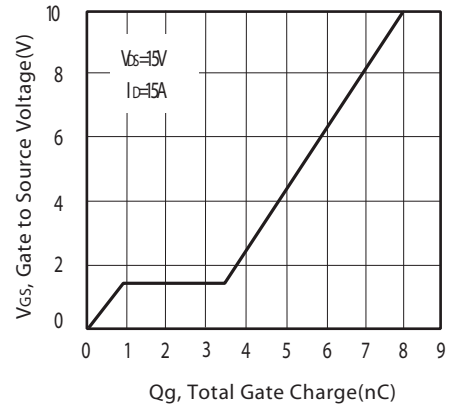

Figure 10. Gate Charge

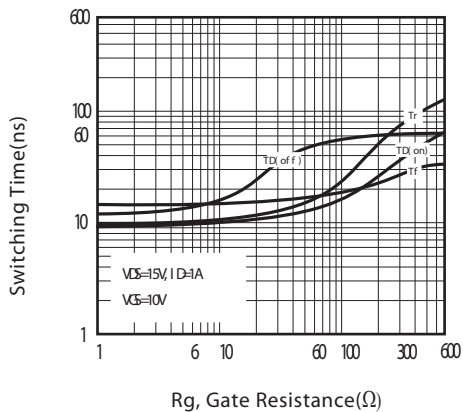

Figure 11. switching characteristics

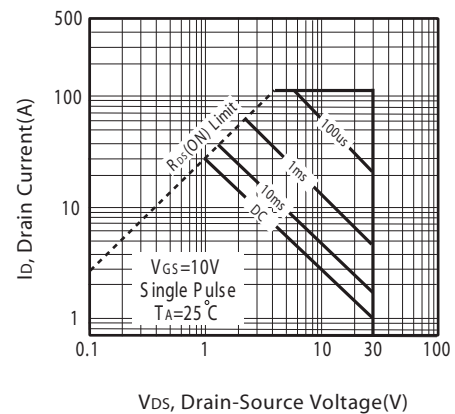
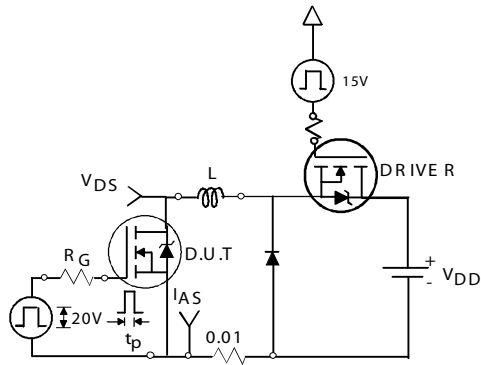
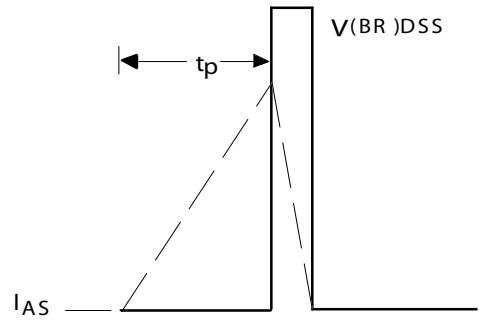

Figure 12. Maximum Safe Operating Area



Unclamped Inductive Test Circuit

Figure 13a.



Unclamped Inductive Waveforms

Figure 13b.

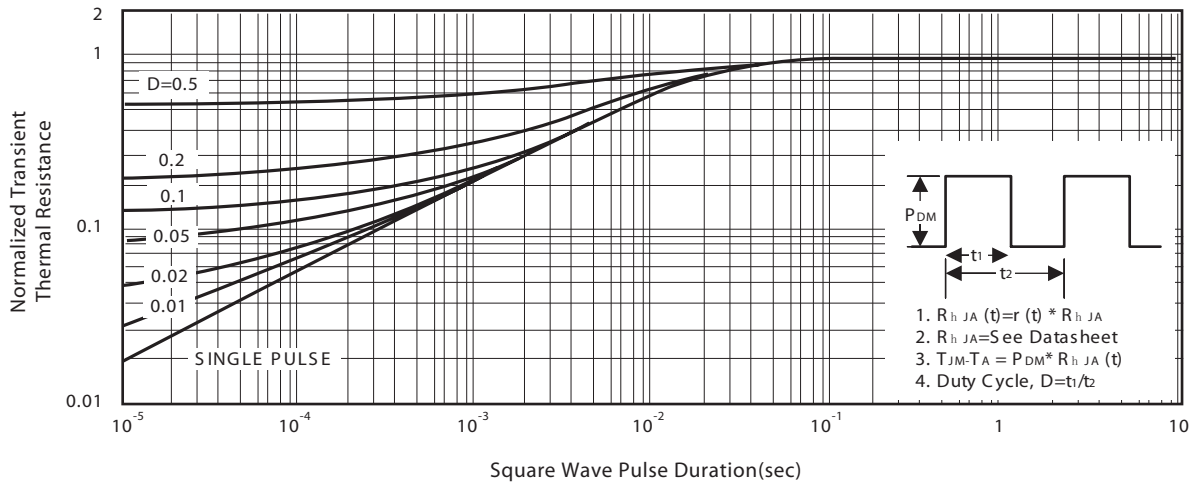
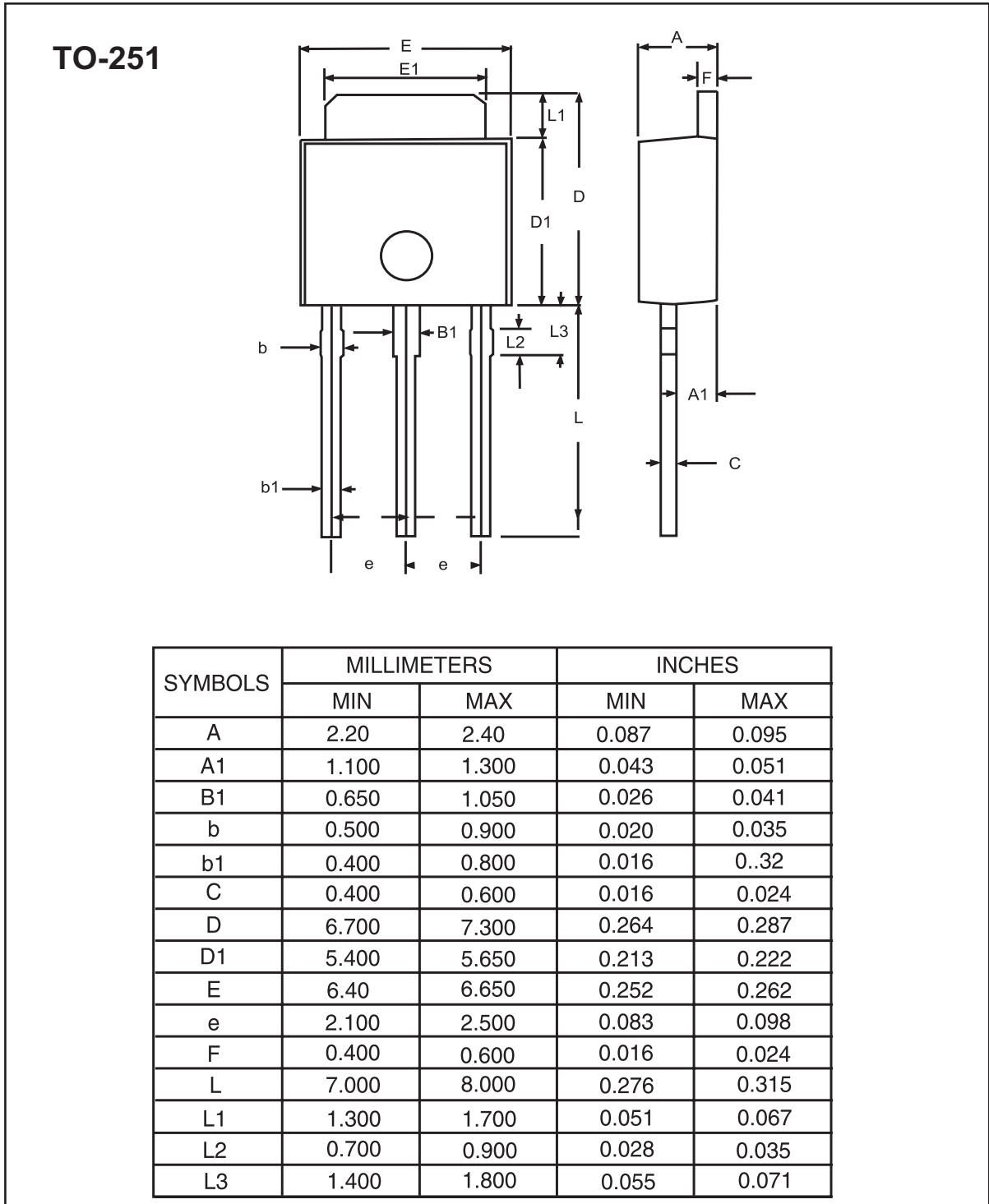

Figure 14. Normalized Thermal Transient Impedance Curve

STU/D320S

Ver 1.0

PACKAGE OUTLINE DIMENSIONS



Aug,11,2008

STU/D320S

Ver 1.0

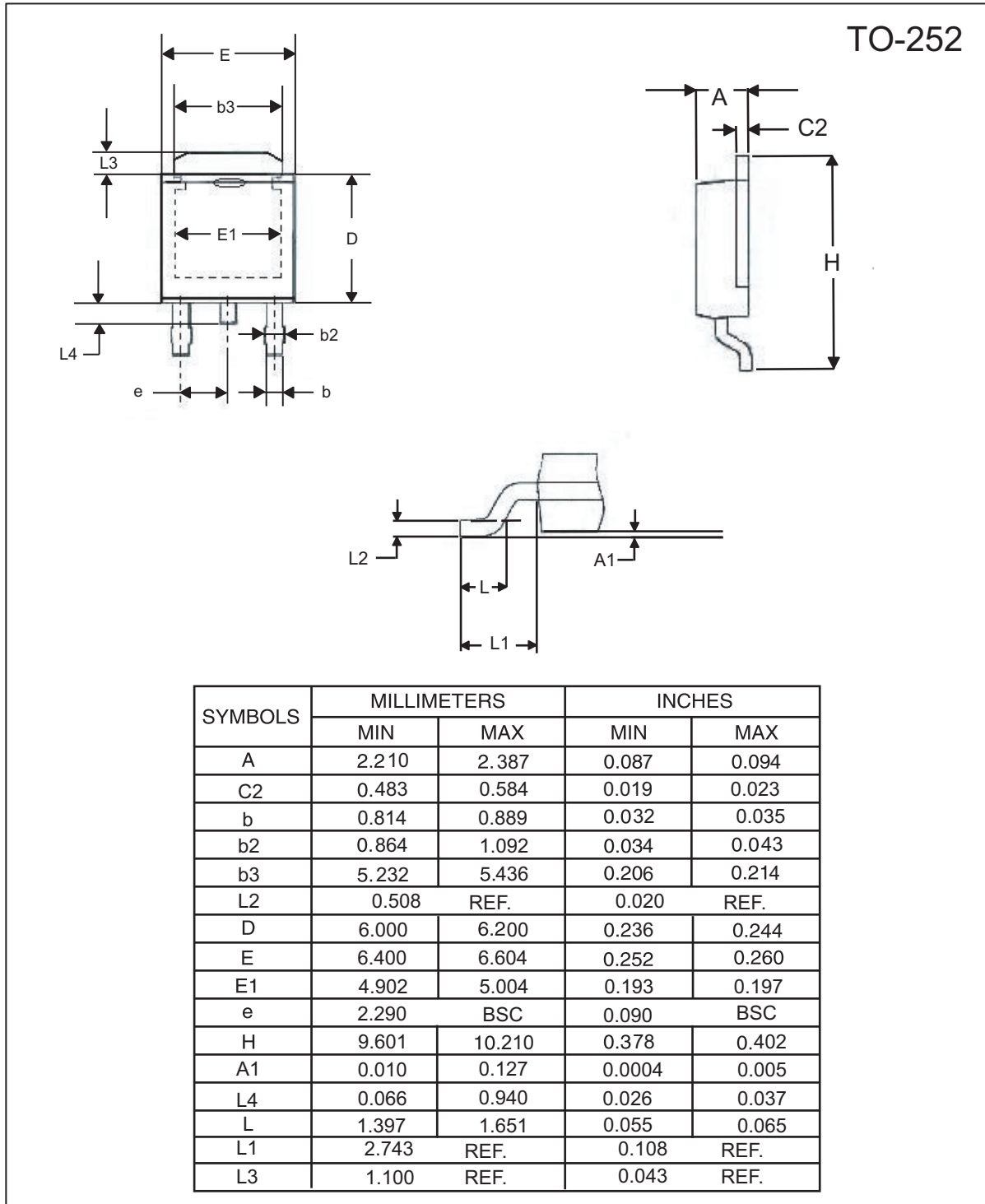

Aug,11,2008

TO-251 Tube/TO-252 Tape and Reel Data

TO-251 Tube

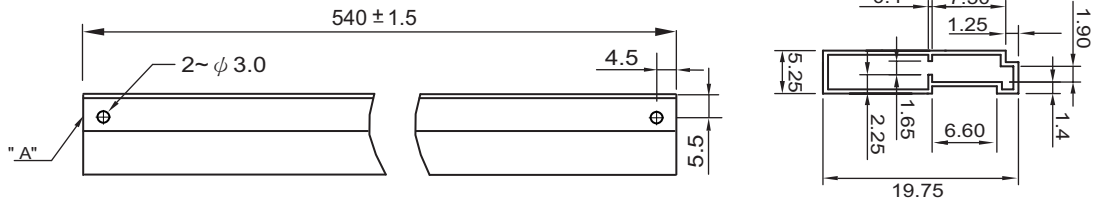

TO-252 Carrier Tape

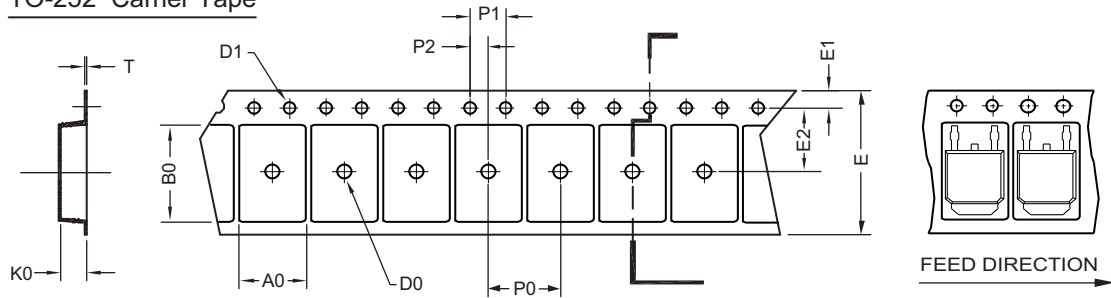

UNIT:mm

PACKAGE	A0	B0	K0	D0	D1	E	E1	E2	P0	P1	P2	T
TO-252 (16 mm)	6.96 ±0.1	10.49 ±0.1	2.79 ±0.1	φ2	φ1.5 +0.1 -0	16.0 ±0.3	1.75 ±0.1	7.5 ±0.15	8.0 ±0.1	4.0 ±0.1	2.0 ±0.15	0.3 ±0.05

TO-252 Reel

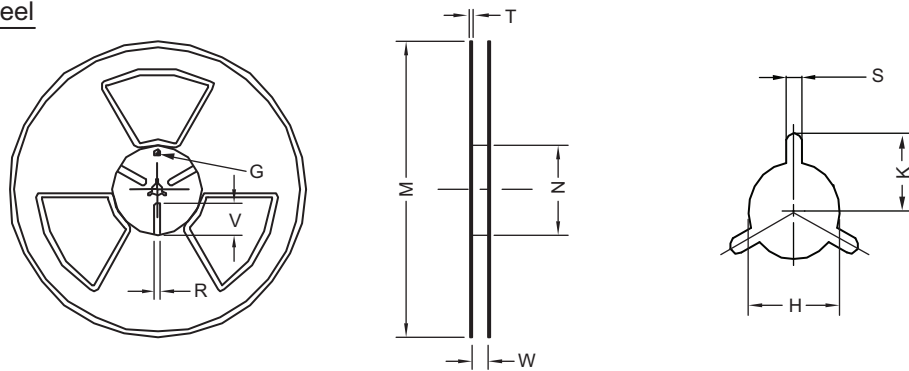

UNIT:mm

TAPE SIZE	REEL SIZE	M	N	W	T	H	K	S	G	R	V
16 mm	φ 330	φ 330 ±0.5	φ 97 ±1.0	17.0 +1.5 -0	2.2	φ 13.0 +0.5 -0.2	10.6	2.0 ±0.5	---	---	---