

T-1 3/4 PACKAGE SOLID STATE LAMP

MVL-504HSG

Description

The MVL-504HSG, a Green source color device, is made with InGaN on Sapphire substrate LED die. The package is T-1 3/4 (5mm) water clear plastic lens package.

Applications

- Full color displays & moving message signs
- Solid state incandescent replacement bulbs
- High ambient panel indicators
- Medical & Analytical instruments

Features

- High performance
- Excellent chip to chip consistency
- High reliability

Package Dimensions

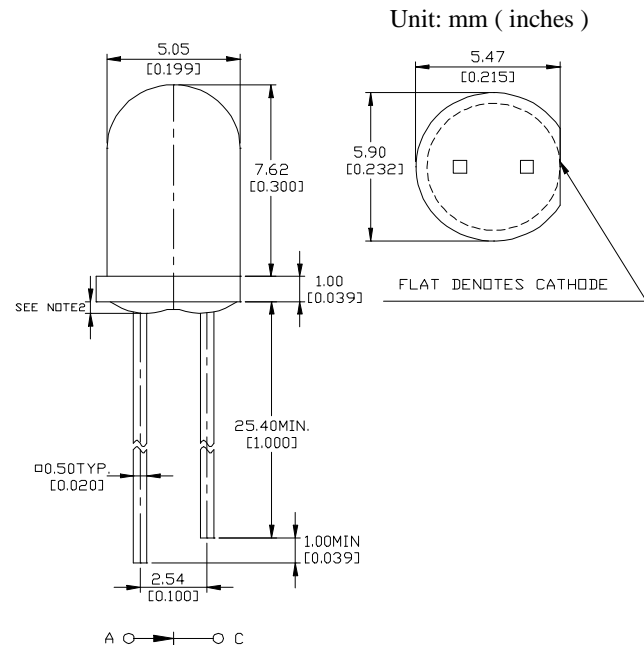

Notes :

1. Tolerance is ± 0.25 mm (.010") unless otherwise noted.
2. Protruded resin under flange is 0.8 mm (.031") max.
3. Lead spacing is measured where the leads emerge from the package.

Absolute Maximum Ratings

@ $T_A = 25^\circ\text{C}$

Parameter	Symbol	Maximum Rating	Unit
Peak Forward Current(1/10 Duty Cycle@ 1KHz)	I_{pf}	100	mA
Continuous Forward Current	I_{af}	30	mA
Reverse Voltage	V_R	5	V
Operating Temperature Range	T_{opr}	-20°C to + 80°C	
Storage Temperature Range	T_{stg}	-30°C to + 100°C	
Electrostatic Discharge Threshold ^{Note 1}		300 V	

Notes: 1. Product resistance to electrostatic discharge (ESD) is measured by simulating ESD using a rapid avalanche energy test (RAET). The RAET procedures are designed to approximate the maximum ESD ratings shown. Seller gives no other assurances regarding the ability of Products to withstand ESD.

UNI

Unity Opto Technology Co., Ltd.

04/04/2002

Optical-Electrical Characteristics

@ T_A=25°C

Parameter	Test Conditions	Symbol	Min .	Typ .	Max .	Unit .
Luminous Intensity	I _F =20mA	I _V	1800	4000	-	mcd
Forward Voltage	I _F =20mA	V _F	-	3.5	4.2	V
Reverse Current	V _R =5V	I _R	-	-	100	μA
Dominant Wavelength	I _F =20mA	λ _d	-	505	-	nm
Viewing Angle	I _F =20mA	2θ _{1/2}	-	15	-	deg.

Typical Optical-Electrical Characteristic Curves

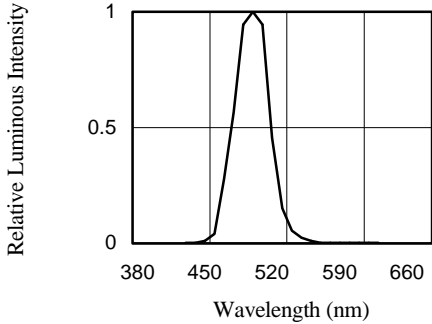

FIG.1 RELATIVE LUMINOUS INTENSITY VS. WAVELENGTH

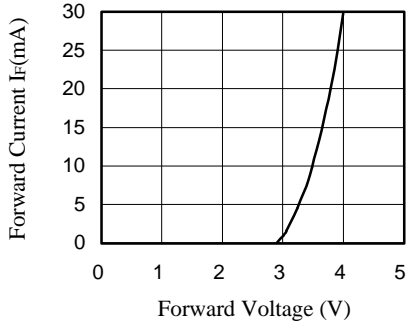

FIG.2 FORWARD CURRENT VS. FORWARD VOLTAGE

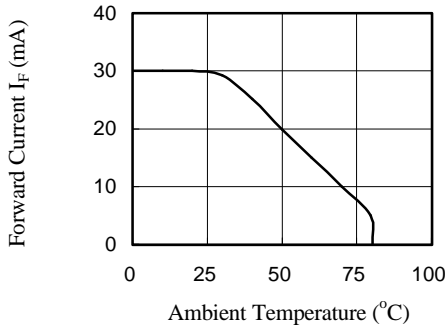

FIG.3 FORWARD CURRENT VS. AMBIENT TEMPERATURE

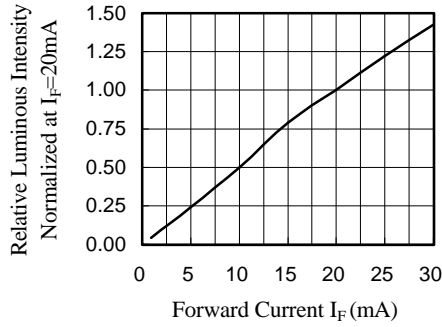

FIG.4 RELATIVE LUMINOUS INTENSITY VS. FORWARD CURRENT

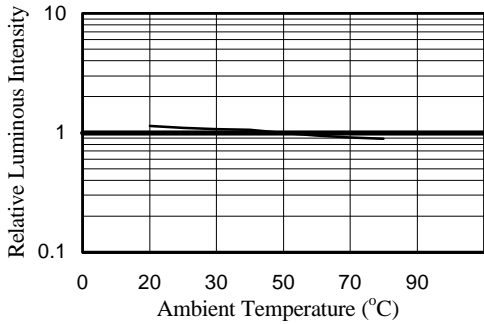

FIG.5 RELATIVE LUMINOUS INTENSITY VS. AMBIENT TEMPERATURE

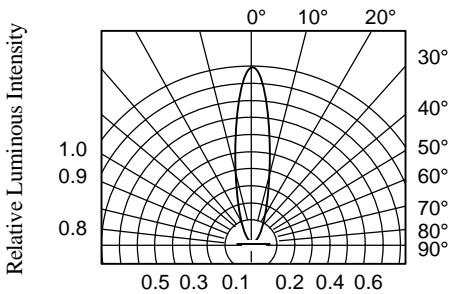

FIG.6 RADIATION DIAGRAM