

SPECIFICATION FOR APPROVAL

REF : 20080424-A

PAGE: 1

PROD. NAME	THIN FILM CHIP INDUCTOR	ABC'S DWG NO.	AL1005□□□□L□-□□□
		ABC'S ITEM NO.	

I . CONFIGURATION & DIMENSIONS :

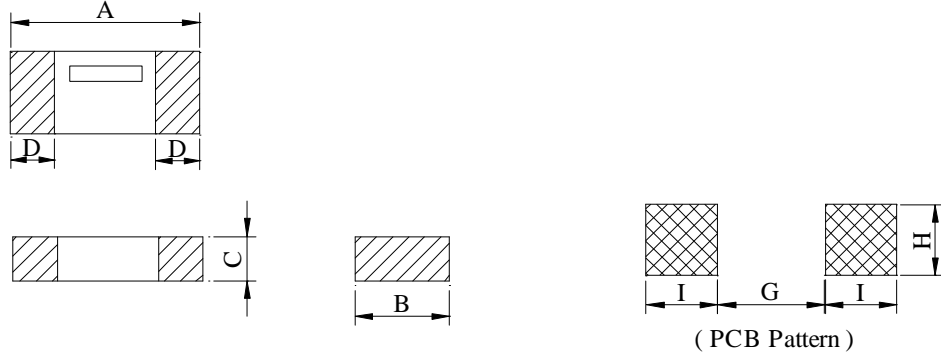

Unit : m/m

Series	A	B	C	D	G	H	I
AL1005	1.00±0.05	0.50±0.05	0.32±0.05	0.20±0.10	0.5	0.6	0.45

II . SCHEMATIC DIAGRAM :



III . MATERIALS :

- a . Body : Ceramic
- b . Internal conductor : Cu
- c . Terminal electrode : Cu/Ni/Sn
- d . Remark : Products comply with RoHS' requirements

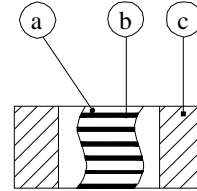

IV . GENERAL SPECIFICATION :

- a . Storage temp. : -40°C --- +105°C
- b . Operating temp. : -55°C --- +125°C
- c . Terminal strength :

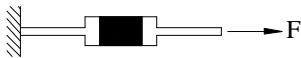

Type	F (kgf)	Time (sec)
AL1005	0.3	30±5

- d . Solderability : Preheat : 150±25°C for 60 seconds
 Solder : Sn96.5 / Ag3 / Cu0.5 or equivalent
 Solder temp. : 260±5°C
 Flux : Rosin
 Dip time : 4±1 seconds

Peak Temp : 260°C max.
 Max time above 230°C : 50sec max.
 Max time above 200°C : 70sec max.

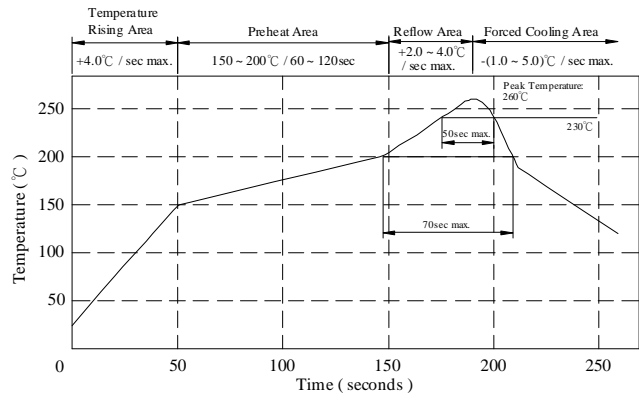

AR-001A

SPECIFICATION FOR APPROVAL

REF : 20080424-A

PAGE: 2-1

PROD. NAME	THIN FILM CHIP INDUCTOR	ABC'S DWG NO.	AL1005□□□□L□-□□□
		ABC'S ITEM NO.	

V . ELECTRICAL CHARACTERISITCS :

DWG No.	Inductance (nH)	Q min	Test Freq. (MHz)	SRF (GHz) min	DC Resistance (Ω) max	Rated Current (mA) max
AL10050N2DL□-□□□	0.2±0.3	13	500	14.0	0.10	800
AL10050N4DL□-□□□	0.4±0.3	13	500	14.0	0.10	800
AL10050N8DL□-□□□	0.8±0.3	13	500	14.0	0.15	700
AL10051N0DL□-□□□	1.0±0.3	13	500	12.0	0.15	700
AL10051N1DL□-□□□	1.1±0.3	13	500	12.0	0.15	700
AL10051N2DL□-□□□	1.2±0.3	13	500	12.0	0.15	700
AL10051N3DL□-□□□	1.3±0.3	13	500	10.0	0.25	700
AL10051N4DL□-□□□	1.4±0.3	13	500	10.0	0.25	700
AL10051N5DL□-□□□	1.5±0.3	13	500	10.0	0.25	700
AL10051N6DL□-□□□	1.6±0.3	13	500	10.0	0.25	560
AL10051N7DL□-□□□	1.7±0.3	13	500	10.0	0.25	560
AL10051N8DL□-□□□	1.8±0.3	13	500	10.0	0.25	560
AL10051N9DL□-□□□	1.9±0.3	13	500	8.0	0.35	560
AL10052N0DL□-□□□	2.0±0.3	13	500	8.0	0.35	560
AL10052N1DL□-□□□	2.1±0.3	13	500	8.0	0.35	440
AL10052N2DL□-□□□	2.2±0.3	13	500	8.0	0.35	440
AL10052N3DL□-□□□	2.3±0.3	13	500	8.0	0.35	440
AL10052N4DL□-□□□	2.4±0.3	13	500	8.0	0.35	440
AL10052N5DL□-□□□	2.5±0.3	13	500	8.0	0.35	440
AL10052N6DL□-□□□	2.6±0.3	13	500	8.0	0.35	440
AL10052N7DL□-□□□	2.7±0.3	13	500	8.0	0.35	440
AL10052N8DL□-□□□	2.8±0.3	13	500	6.0	0.45	380
AL10052N9DL□-□□□	2.9±0.3	13	500	6.0	0.45	380
AL10053N0DL□-□□□	3.0±0.3	13	500	6.0	0.45	380
AL10053N1DL□-□□□	3.1±0.3	13	500	6.0	0.45	380
AL10053N2DL□-□□□	3.2±0.3	13	500	6.0	0.45	380
AL10053N3DL□-□□□	3.3±0.3	13	500	6.0	0.45	380
AL10053N4DL□-□□□	3.4±0.3	13	500	6.0	0.55	380
AL10053N5DL□-□□□	3.5±0.3	13	500	6.0	0.55	380
AL10053N6DL□-□□□	3.6±0.3	13	500	6.0	0.55	380
AL10053N7DL□-□□□	3.7±0.3	13	500	6.0	0.55	340
AL10053N8DL□-□□□	3.8±0.3	13	500	6.0	0.55	340
AL10053N9DL□-□□□	3.9±0.3	13	500	6.0	0.55	340
AL10054N7DL□-□□□	4.7±0.3	13	500	6.0	0.65	320
AL10055N6DL□-□□□	5.6±0.3	13	500	6.0	0.85	280
AL10055N9DL□-□□□	5.9±0.3	13	500	6.0	0.85	280
AL10056N8DL□-□□□	6.8±0.3	13	500	6.0	1.05	260

AR-001A



SPECIFICATION FOR APPROVAL

REF : 20080424-A

PAGE: 2-2

PROD. NAME	THIN FILM CHIP INDUCTOR	ABC'S DWG NO.	AL1005□□□□L□-□□□
		ABC'S ITEM NO.	

DWG No.	Inductance (nH)	Q min	Test Freq. (MHz)	SRF (GHz) min	DC Resistance (Ω) max	Rated Current (mA) max
AL10057N2DL□-□□□	7.2±0.3	13	500	6.0	1.05	260
AL10058N0DL□-□□□	8.0±0.3	13	500	5.5	1.25	220
AL10058N2DL□-□□□	8.2±0.3	13	500	5.5	1.25	220
AL10059N1DL□-□□□	9.1±0.3	13	500	5.5	1.25	220
AL100510NJL□-□□□	10.0±5 %	13	500	4.5	1.35	200
AL100512NJL□-□□□	12.0±5 %	13	500	3.7	1.55	180
AL100514NJL□-□□□	13.8±5 %	13	500	3.7	1.75	180
AL100515NJL□-□□□	15.0±5 %	13	500	3.3	1.75	130
AL100517NJL□-□□□	17.0±5 %	13	500	3.1	1.95	100
AL100518NJL□-□□□	18.0±5 %	13	500	3.1	2.15	100
AL100521NJL□-□□□	20.8±5 %	13	500	2.8	2.55	90
AL100522NJL□-□□□	22.0±5 %	13	500	2.8	2.65	90
AL100527NJL□-□□□	27.0±5 %	13	500	2.5	3.25	75
AL100533NJL□-□□□	33.0±5 %	13	500	2.5	4.50	75

- 1). □ : Packaging Information... [A] : Bulk [B]: Taping Reel
 2). "- □□□ ":Reference code
 3). Tolerance : B : ±0.1 C : ±0.2 D : ±0.3 G : ±2% J : ±5%

AR-001A



SPECIFICATION FOR APPROVAL

REF : 20080424-A

PAGE: 3

PROD. NAME	THIN FILM CHIP INDUCTOR	ABC'S DWG NO.	AL1005□□□□L□-□□□
		ABC'S ITEM NO.	

VI . PACKAGING INFORMATION :

(1) Configuration

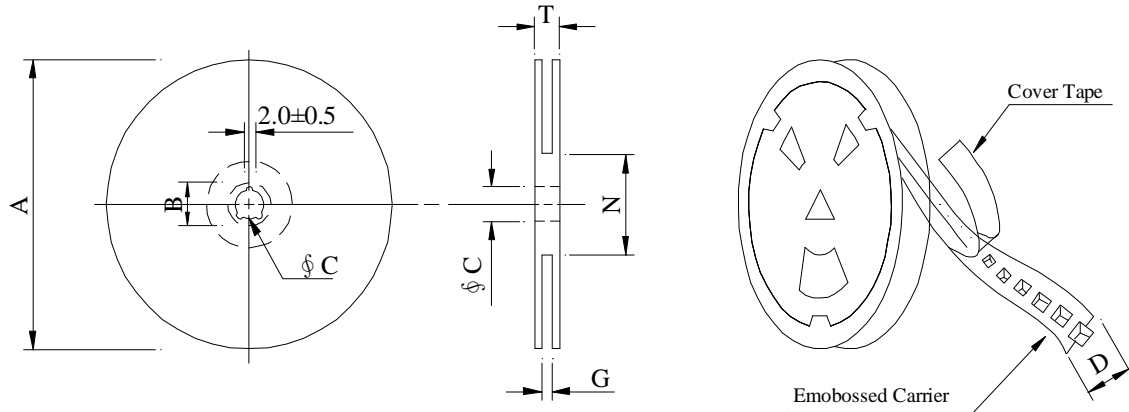

※Carrier tape width : D

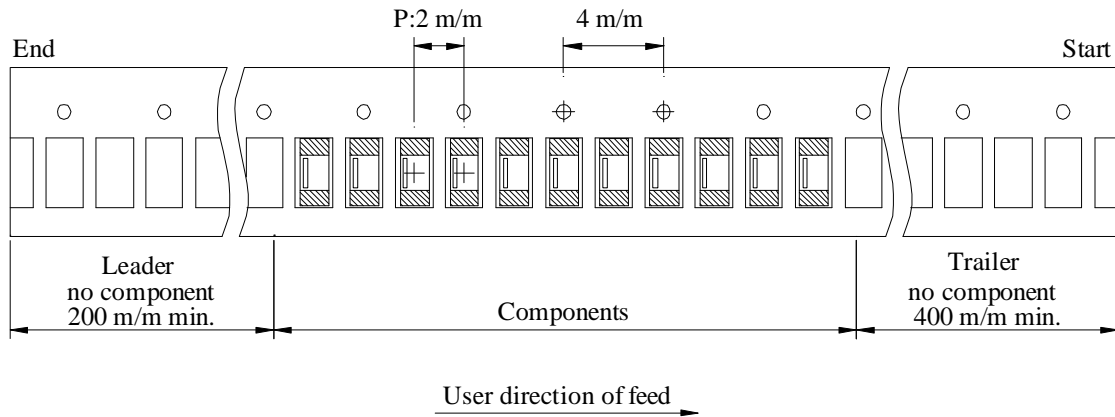

(2) Dimensions

Unit:m/m

Style	A	B	C	D	G	N	T
07 - 08	178	21±0.8	13	8	10 ⁺⁰	50 ⁻⁰	12.5

(3) Q'TY & G.W. Per package

Series	Inner : Reel			Outer : Carton		
	Q'TY (pcs)	G.W. (gw)	Style	Q'TY (pcs)	G.W. (Kg)	Size (cm)
AL1005	10,000	60	07 - 08	500,000	5.5	41x 39 x 22

AR-001A

SPECIFICATION FOR APPROVAL

REF : 20080424-A

PAGE: 4

PROD. NAME	THIN FILM CHIP INDUCTOR	ABC'S DWG NO.	AL1005□□□□L□-□□□
		ABC'S ITEM NO.	

VII . DWGING NUMBER EXPRESSION :

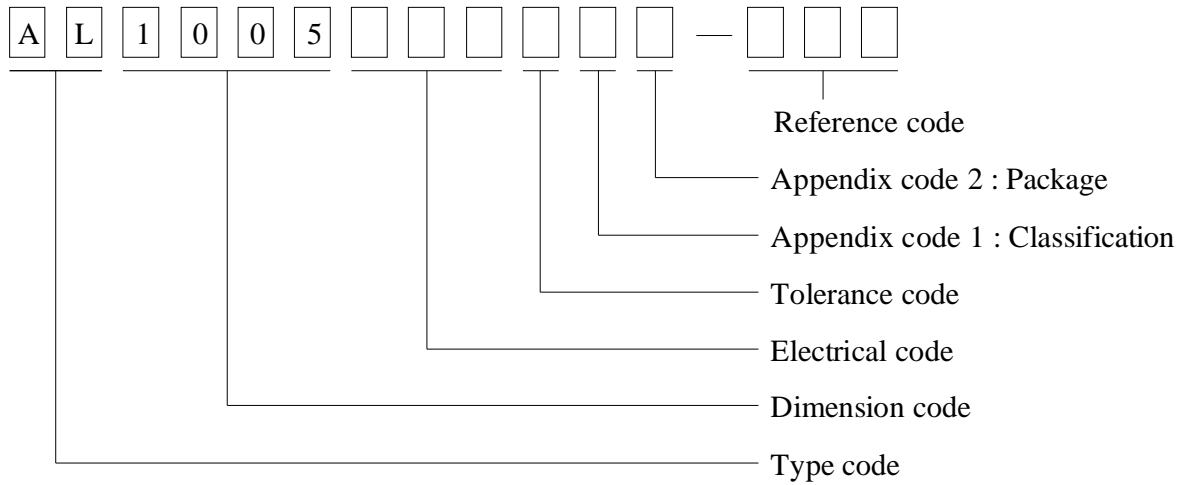

Appendix code 1 : Product Classification

L : Lead Free Standard products comply with RoHS' requirements

1 ~ 9 : Lead Free Special products comply with RoHS' requirements

Appendix code 2 : Package Information

Code	Inner package	Inner package QTY	Remark
A	T.B.D.	T.B.D.	
B	T / R (Reel package)	10000 pcs	

SPECIFICATION FOR APPROVAL

REF : 20080424-A

PAGE: 5

PROD. NAME	THIN FILM CHIP INDUCTOR	ABC'S DWG No.	AL1005□□□□L□-□□□
		ABC'S ITEM No.	

VIII . RELIABILITY TEST :

Test item	Specification	Test condition						
Solderability	More than 95% of the terminal electrode shall be covered With fresh solder.	Preheat : 155°C / 4 hours. Solder : Sn96.5 / Ag3 / Cu0.5 or equivalent Solder temp. : 235±5°C Flux : Rosin Dip time : 5±0.5 seconds						
Thermal shock test (Temp. cycle)	Electrical oharacteristics shall not change more than ±20%	<table style="width: 100%; border: none;"> <tr> <td style="text-align: center;">Room temp. 15 minutes</td> <td style="text-align: center;">→</td> <td style="text-align: center;">-55 °C 30 minutes</td> </tr> <tr> <td style="text-align: center;">Room temp. 15 minutes</td> <td style="text-align: center;">→</td> <td style="text-align: center;">+125 °C 30 minutes</td> </tr> </table> <p>Total : 50 cycles</p>	Room temp. 15 minutes	→	-55 °C 30 minutes	Room temp. 15 minutes	→	+125 °C 30 minutes
Room temp. 15 minutes	→	-55 °C 30 minutes						
Room temp. 15 minutes	→	+125 °C 30 minutes						
Humidity Test		Temperature : 40±2°C Humidity : 90±5% Time : 1000 hours						
High temp. Resistance test		Temperature : 125±5°C Applied current : Per spec. Time : 96 hours						

AR-001A

