

Application

LNA and wide band amplifier up to GHz range

Features

o Low Noise Figure

NF = 1.0 dB at f = 1 GHz, $V_{CE} = 3\text{ V}$, $I_C = 7\text{ mA}$

o High Power Gain

MAG = 15 dB at f = 1 GHz, $V_{CE} = 3\text{ V}$, $I_C = 7\text{ mA}$

o High Transition Frequency

$f_T = 9\text{ GHz}$ at $V_{CE} = 3\text{ V}$, $I_C = 30\text{ mA}$

SOT-523 Unit in mm

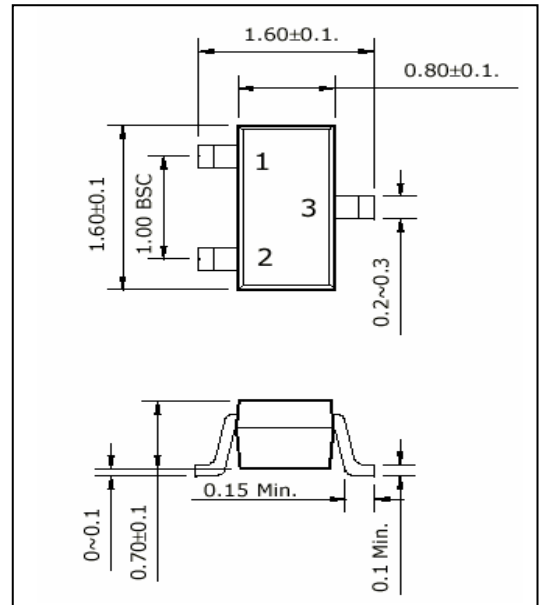

Pin Configuration

Pin No	Symbol	Description
1	B	Base
2	E	Emitter
3	C	Collector

h_{FE} Classification

Marking	AB1	AB2
h_{FE}	125 to 300	80 to 160

Available Package

Unit : mm

Product	Package	Dimension
THN6501S	SOT-23	2.9 x 1.3, 1.2t
THN6501U	SOT-323	2.0 x 1.25, 1.0t
THN6501Z	SOT-343	2.0 x 1.25, 1.0t
THN6501E	SOT-523	1.6 x 0.8, 0.8t

Absolute Maximum Ratings

Symbol	Parameter	Ratings	Unit
V_{CBO}	Collector to Base Breakdown Voltage	20	V
V_{CEO}	Collector to Emitter Breakdown Voltage	12	V
V_{EBO}	Emitter to Base Breakdown Voltage	2.5	V
I_C	Collector Current (DC)	100	mA
P_T	Total Power Dissipation	150	mW
T_{STG}	Storage Temperature	-65 ~ 150	°C
T_J	Operating Junction Temperature	150	°C

Caution : Electro Static Senetive Device

THN6501 Series

□ **Electrical Characteristics** ($T_A = 25\text{ }^\circ\text{C}$)

Symbol	Parameter	Test Condition	Value			Unit
			Min.	Typ.	Max.	
I_{CBO}	Collector Cut-off Current	$V_{CB} = 19\text{ V}, I_E = 0\text{ mA}$			0.5	μA
I_{CEO}		$V_{CE} = 12\text{ V}, I_B = 0\text{ mA}$			5	μA
I_{EBO}	Emitter Cut-off Current	$V_{EB} = 1\text{ V}, I_C = 0\text{ mA}$			0.5	μA
h_{FE}	DC Current Gain	$V_{CE} = 3\text{ V}, I_C = 15\text{ mA}$	80	150	300	
f_T	Transition Frequency	$V_{CE} = 3\text{ V}, I_C = 30\text{ mA}$	8	9		GHz
C_{CB}	Collector to Base Capacitance	$V_{CB} = 10\text{ V}, f = 1\text{ MHz}$		0.85		pF
$ S_{21} ^2$	Insertion Power Gain	$V_{CE} = 3\text{ V}, I_C = 7\text{ mA}, f = 1\text{ GHz}$	8	9.5		dB
		$V_{CE} = 3\text{ V}, I_C = 15\text{ mA}, f = 1\text{ GHz}$	9	11		
MAG	Maximum Available Gain	$V_{CE} = 3\text{ V}, I_C = 7\text{ mA}, f = 1\text{ GHz}$	12.5	14.5		dB
		$V_{CE} = 3\text{ V}, I_C = 15\text{ mA}, f = 1\text{ GHz}$	13	15		
NFmin	Minimum Noise Figure	$V_{CE} = 3\text{ V}, I_C = 7\text{ mA}, f = 1\text{ GHz}$		1.0		dB
rn	Noise Resistance	$V_{CE} = 3\text{ V}, I_C = 7\text{ mA}, f = 1\text{ GHz}$		0.049		Ω
G_A	Associated Gain	$V_{CE} = 3\text{ V}, I_C = 7\text{ mA}, f = 1\text{ GHz}$	10	12		dB
		$V_{CE} = 3\text{ V}, I_C = 15\text{ mA}, f = 1\text{ GHz}$	10	12.5		
OIP ₃	Output 3rd Order Intercept	$V_{CE} = 6\text{ V}, I_C = 15\text{ mA}, f = 1\text{ GHz}$		27		dBm

THN6501 Series

Total Power Dissipation, P_T vs. T_A

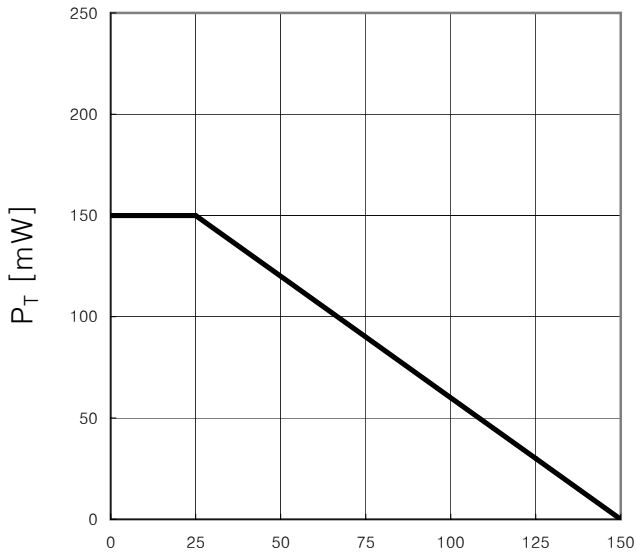

Ambient Temperature, T_A [°C]

I_C vs. V_{CE}

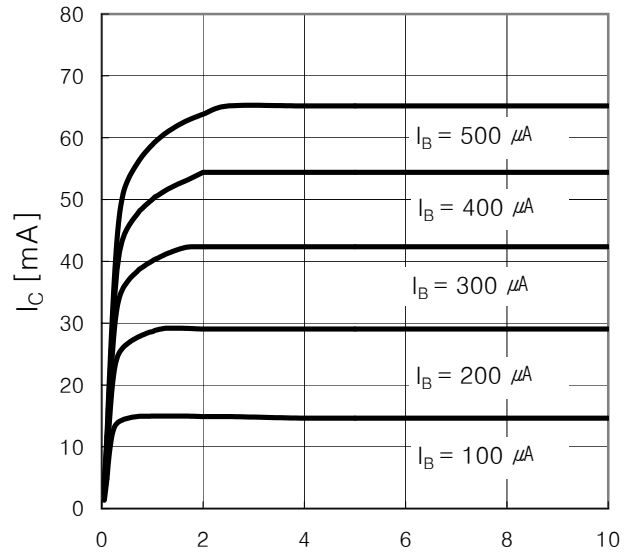

V_{CE} [V]

I_C vs. V_{BE}

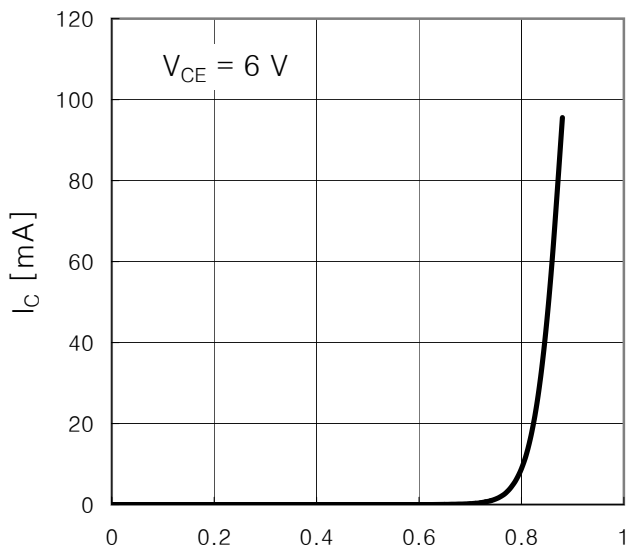

V_{BE} [V]

h_{FE} vs. I_C

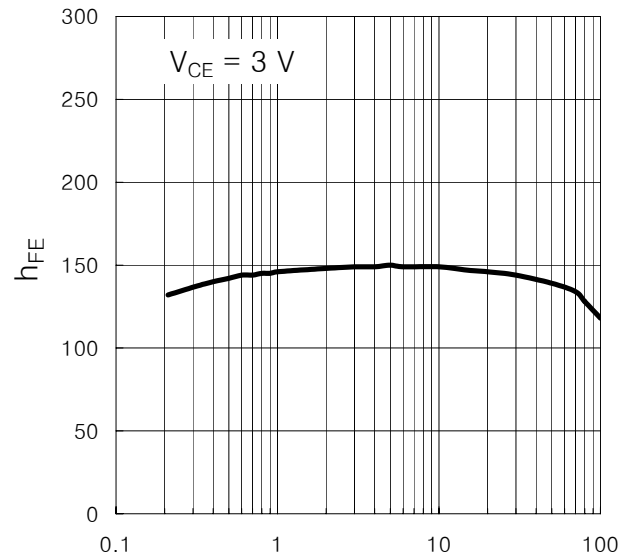

I_C [mA]

THN6501 Series

Maximum Available Gain, MAG vs. Frequency

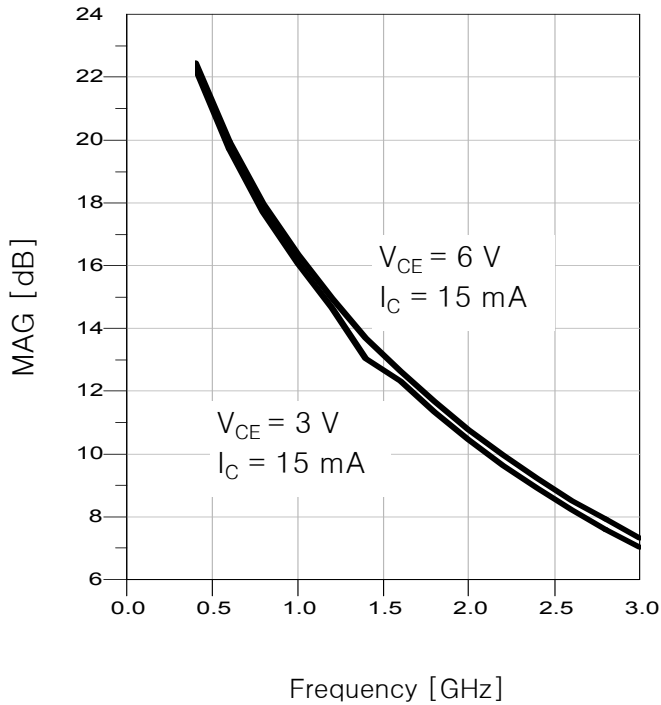

Insertion Power Gain, $|S_{21}|^2$ vs. Frequency

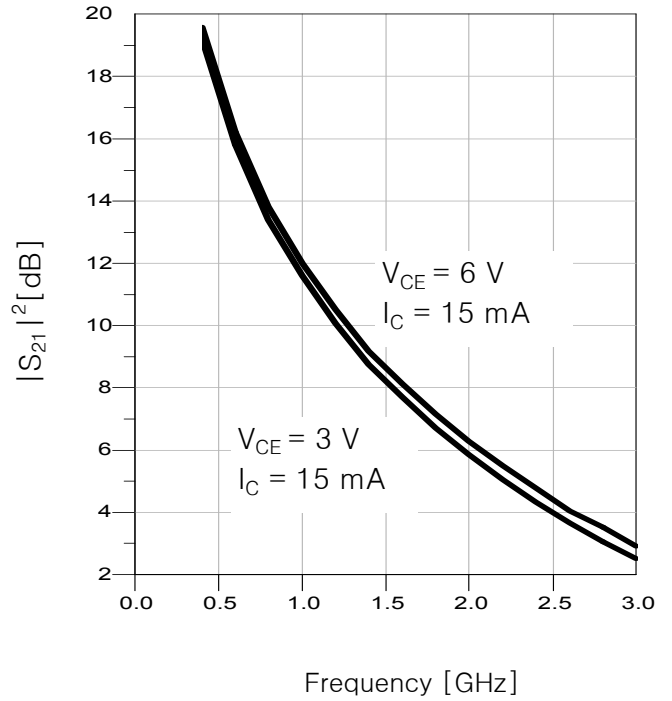

Transition Frequency, f_T vs. I_C

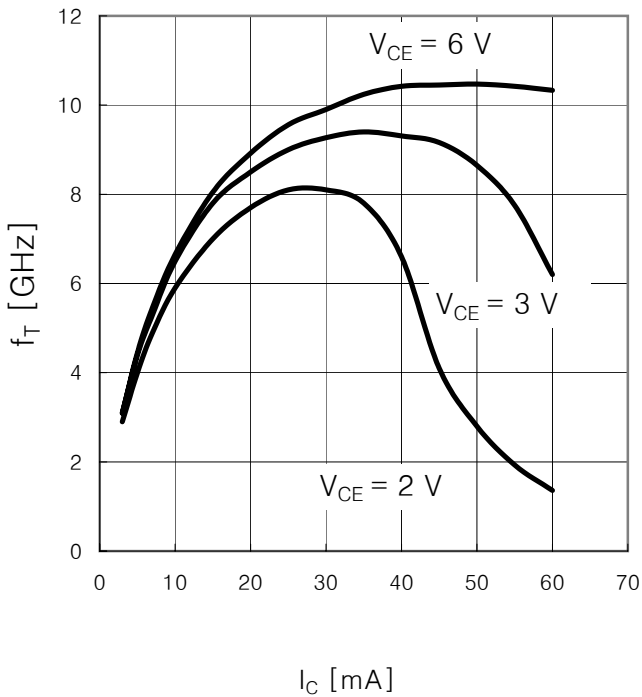

Maximum Available Gain, MAG vs. I_C

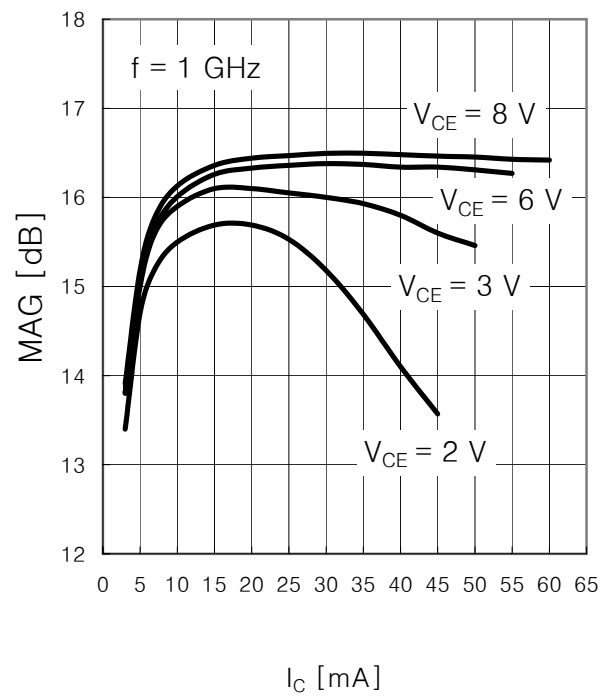

THN6501 Series

Output 3rd Order Intercept Point, OIP₃ vs. I_C
(Z_S = Z_L = 50 Ω)

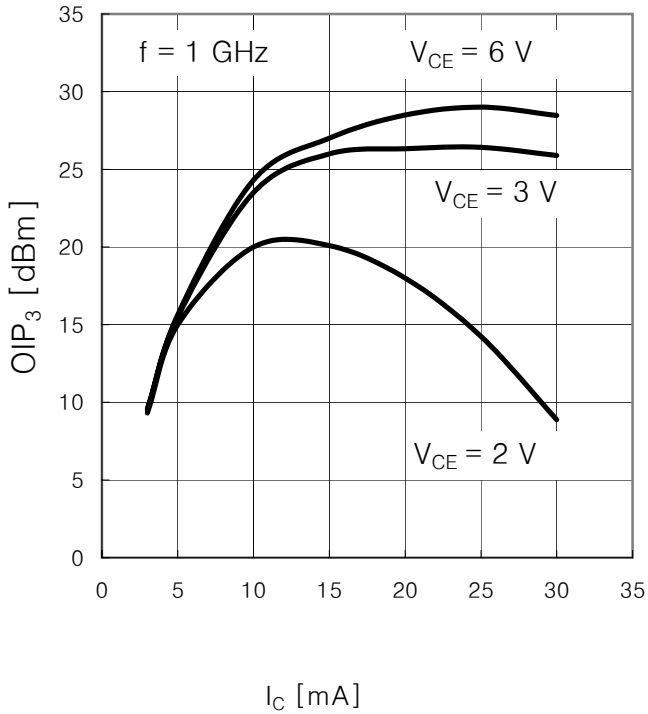

C_{CB} vs. V_{CB}

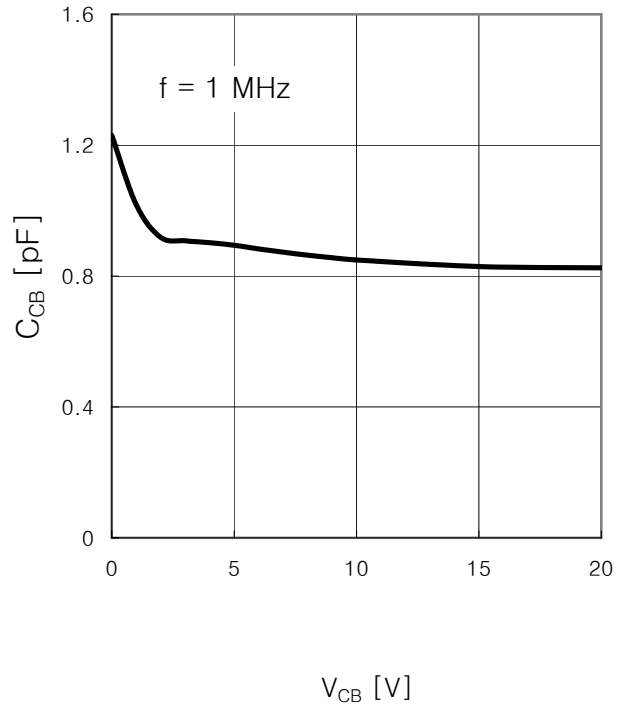

NF vs. I_C
V_{CE} = 3 V, I_C = parameter, Z_S = Z_{Sopt}

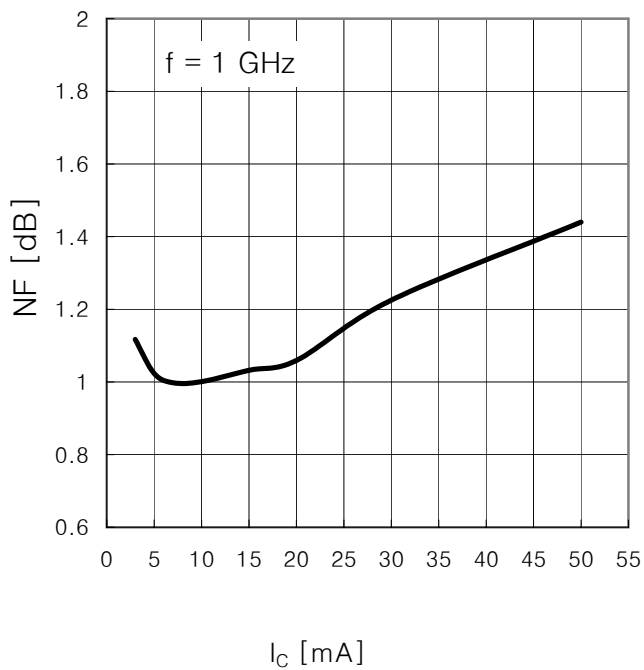

Noise Figure Contours & Constant Gain
f = 1 GHz, V_{CE} = 3 V, I_C = 7 mA

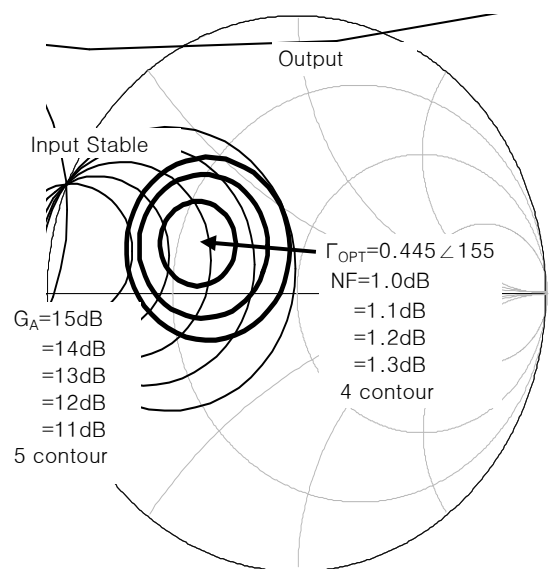

THN6501 Series

□ Dimensions of THN6501S in mm

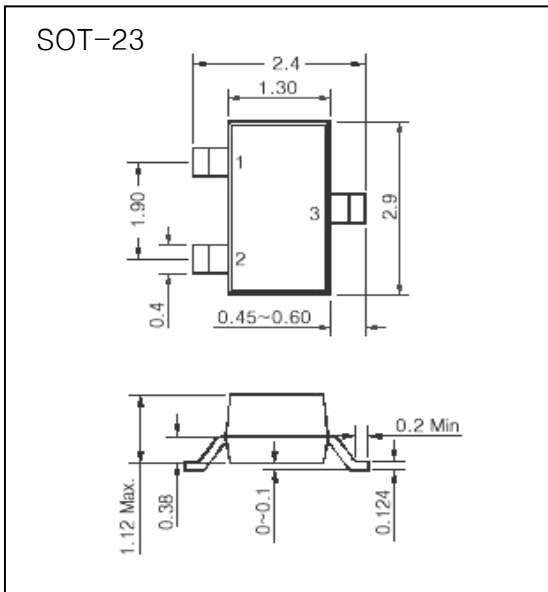

□ Dimensions of THN6501U in mm

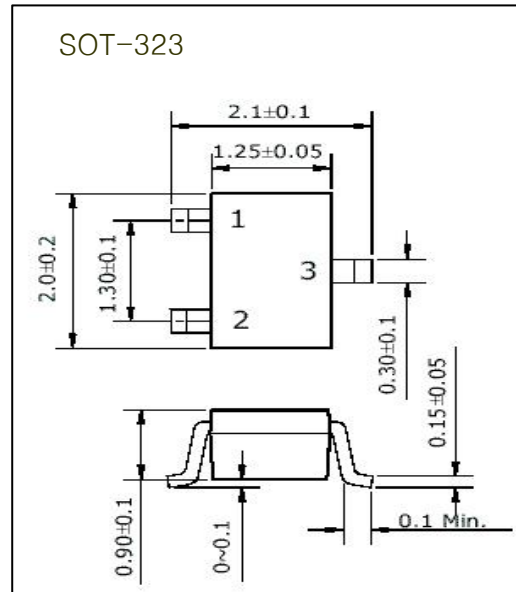

Pin Configuration (SOT-23, SOT-323)

Pin No	Symbol	Description
1	B	Base
2	E	Emitter
3	C	Collector

□ Dimensions of THN6501Z in mm

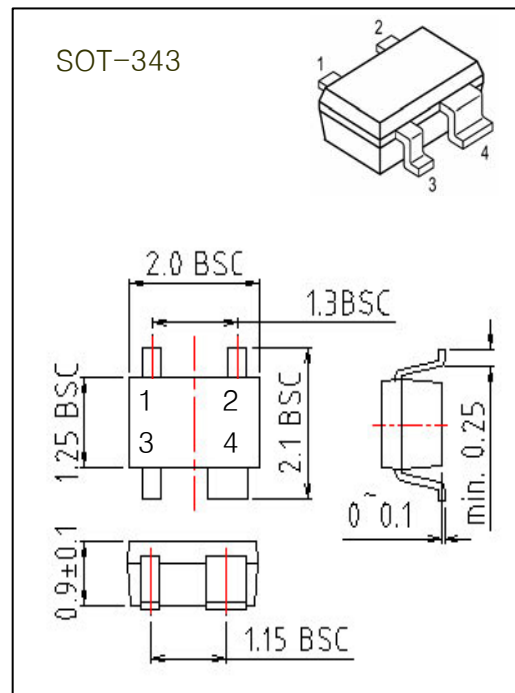

Pin Configuration (SOT-343)

Pin No	Symbol	Description
1	B	Base
2, 3	E	Emitter
4	C	Collector

THN6501 Series

□ Common Emitter S-Parameter Data

at $V_{CE} = 3\text{ V}$, $I_C = 3\text{ mA}$

freq	S(1,1)	S(2,1)	S(1,2)	S(2,2)
400.0MHz	0.714 / -115.452	5.565 / 107.076	0.108 / 31.648	0.582 / -64.908
600.0MHz	0.690 / -138.684	4.020 / 91.928	0.113 / 24.085	0.484 / -77.742
800.0MHz	0.666 / -152.914	3.117 / 80.397	0.112 / 21.299	0.445 / -87.476
1.000GHz	0.682 / -164.364	2.551 / 70.634	0.107 / 21.803	0.432 / -95.539
1.200GHz	0.689 / -169.057	2.155 / 63.476	0.103 / 25.432	0.424 / -103.228
1.400GHz	0.698 / -175.650	1.853 / 56.729	0.101 / 31.155	0.437 / -109.983
1.600GHz	0.708 / 177.882	1.628 / 49.986	0.102 / 38.737	0.454 / -116.920
1.800GHz	0.722 / 172.343	1.449 / 44.131	0.109 / 46.385	0.476 / -123.483
2.000GHz	0.730 / 167.346	1.300 / 38.478	0.120 / 53.134	0.501 / -129.766
2.200GHz	0.738 / 162.750	1.171 / 33.644	0.137 / 57.979	0.526 / -135.822
2.400GHz	0.755 / 157.300	1.064 / 29.264	0.156 / 61.027	0.553 / -141.065
2.600GHz	0.768 / 152.736	0.968 / 25.179	0.178 / 62.241	0.576 / -146.526
2.800GHz	0.779 / 148.445	0.899 / 21.783	0.201 / 62.451	0.604 / -151.541
3.000GHz	0.785 / 142.738	0.829 / 18.837	0.225 / 61.842	0.630 / -155.871

at $V_{CE} = 3\text{ V}$, $I_C = 5\text{ mA}$

freq	S(1,1)	S(2,1)	S(1,2)	S(2,2)
400.0MHz	0.657 / -132.394	6.948 / 101.846	0.087 / 32.734	0.471 / -79.552
600.0MHz	0.645 / -151.156	4.872 / 88.860	0.091 / 30.079	0.387 / -92.997
800.0MHz	0.639 / -164.080	3.738 / 79.025	0.093 / 31.498	0.358 / -102.662
1.000GHz	0.652 / -172.711	3.043 / 70.561	0.096 / 34.927	0.352 / -110.068
1.200GHz	0.664 / -176.640	2.564 / 64.414	0.100 / 39.863	0.345 / -117.108
1.400GHz	0.663 / 177.624	2.207 / 58.324	0.106 / 44.983	0.358 / -122.783
1.600GHz	0.679 / 172.827	1.946 / 52.178	0.115 / 49.654	0.375 / -128.454
1.800GHz	0.697 / 167.713	1.738 / 47.052	0.128 / 53.639	0.397 / -133.775
2.000GHz	0.698 / 163.448	1.565 / 41.476	0.142 / 56.603	0.421 / -138.819
2.200GHz	0.704 / 158.860	1.422 / 36.811	0.159 / 58.720	0.446 / -143.704
2.400GHz	0.718 / 154.220	1.294 / 32.575	0.177 / 59.803	0.472 / -147.816
2.600GHz	0.731 / 150.120	1.186 / 28.342	0.197 / 59.879	0.496 / -152.247
2.800GHz	0.748 / 145.931	1.101 / 24.732	0.217 / 59.588	0.524 / -156.315
3.000GHz	0.751 / 140.712	1.026 / 21.629	0.238 / 58.773	0.552 / -159.854

at $V_{CE} = 3\text{ V}$, $I_C = 7\text{ mA}$

freq	S(1,1)	S(2,1)	S(1,2)	S(2,2)
400.0MHz	0.640 / -142.726	7.782 / 98.644	0.073 / 35.433	0.409 / -91.276
600.0MHz	0.636 / -159.398	5.377 / 87.127	0.080 / 36.252	0.341 / -105.497
800.0MHz	0.631 / -169.952	4.102 / 78.225	0.085 / 39.583	0.321 / -114.948
1.000GHz	0.649 / -177.490	3.336 / 70.575	0.093 / 43.704	0.318 / -121.797
1.200GHz	0.657 / 178.802	2.807 / 64.976	0.101 / 48.209	0.312 / -128.653
1.400GHz	0.657 / 174.123	2.415 / 59.224	0.112 / 51.867	0.325 / -133.341
1.600GHz	0.669 / 169.452	2.127 / 53.614	0.125 / 54.886	0.342 / -138.135
1.800GHz	0.683 / 164.806	1.904 / 48.629	0.139 / 57.078	0.362 / -142.536
2.000GHz	0.687 / 160.547	1.717 / 43.524	0.155 / 58.519	0.384 / -146.639
2.200GHz	0.692 / 156.583	1.559 / 38.983	0.172 / 59.254	0.408 / -150.681
2.400GHz	0.704 / 152.445	1.433 / 34.774	0.190 / 59.452	0.433 / -153.954
2.600GHz	0.723 / 148.592	1.315 / 30.781	0.208 / 58.995	0.456 / -157.568
2.800GHz	0.729 / 144.556	1.228 / 26.756	0.227 / 58.248	0.483 / -160.950
3.000GHz	0.733 / 140.019	1.141 / 23.770	0.247 / 57.196	0.510 / -163.831

at $V_{CE} = 3\text{ V}$, $I_C = 10\text{ mA}$

freq	S(1,1)	S(2,1)	S(1,2)	S(2,2)
400.0MHz	0.619 / -152.597	8.509 / 95.545	0.062 / 39.919	0.361 / -105.116
600.0MHz	0.629 / -166.837	5.819 / 85.370	0.071 / 43.878	0.312 / -119.401
800.0MHz	0.624 / -176.127	4.421 / 77.569	0.081 / 48.151	0.300 / -128.393
1.000GHz	0.644 / 177.554	3.582 / 70.305	0.092 / 51.905	0.301 / -134.549
1.200GHz	0.648 / 174.442	3.021 / 65.300	0.105 / 55.345	0.296 / -141.051
1.400GHz	0.655 / 170.794	2.594 / 60.198	0.119 / 57.471	0.308 / -144.844
1.600GHz	0.660 / 166.141	2.291 / 54.879	0.134 / 58.937	0.324 / -148.753
1.800GHz	0.671 / 161.753	2.050 / 50.135	0.150 / 59.734	0.342 / -152.194
2.000GHz	0.679 / 158.164	1.854 / 45.271	0.166 / 60.062	0.362 / -155.441
2.200GHz	0.680 / 154.148	1.688 / 40.871	0.184 / 59.835	0.384 / -158.610
2.400GHz	0.693 / 150.142	1.551 / 36.926	0.201 / 59.334	0.407 / -161.094
2.600GHz	0.710 / 146.244	1.433 / 32.962	0.219 / 58.383	0.427 / -163.962
2.800GHz	0.717 / 142.621	1.337 / 29.094	0.237 / 57.282	0.452 / -166.624
3.000GHz	0.725 / 137.991	1.245 / 25.829	0.256 / 56.034	0.477 / -168.805

THN6501 Series

at $V_{CE} = 3\text{ V}$, $I_c = 15\text{ mA}$

freq	S(1,1)	S(2,1)	S(1,2)	S(2,2)
400.0MHz	0.615 / -162.748	9.116 / 92.686	0.054 / 46.995	0.331 / -120.522
600.0MHz	0.631 / -173.478	6.171 / 83.868	0.066 / 52.300	0.301 / -133.988
800.0MHz	0.628 / 179.045	4.677 / 76.744	0.079 / 56.373	0.297 / -141.838
1.000GHz	0.632 / 172.562	3.797 / 70.166	0.094 / 59.031	0.299 / -147.023
1.200GHz	0.649 / 171.133	3.189 / 65.625	0.109 / 60.996	0.296 / -153.245
1.400GHz	0.652 / 167.208	2.740 / 60.893	0.125 / 61.912	0.308 / -156.221
1.600GHz	0.658 / 163.492	2.424 / 55.954	0.142 / 62.099	0.321 / -159.336
1.800GHz	0.674 / 158.923	2.167 / 51.405	0.159 / 61.907	0.337 / -162.072
2.000GHz	0.671 / 155.577	1.964 / 46.771	0.177 / 61.310	0.355 / -164.600
2.200GHz	0.675 / 152.239	1.788 / 42.492	0.194 / 60.406	0.373 / -167.026
2.400GHz	0.689 / 147.949	1.647 / 38.688	0.212 / 59.359	0.393 / -168.800
2.600GHz	0.698 / 144.470	1.524 / 35.088	0.230 / 57.911	0.411 / -170.960
2.800GHz	0.706 / 141.024	1.420 / 31.228	0.247 / 56.516	0.434 / -173.016
3.000GHz	0.714 / 136.683	1.335 / 28.032	0.265 / 55.051	0.456 / -174.663

at $V_{CE} = 3\text{ V}$, $I_c = 20\text{ mA}$

freq	S(1,1)	S(2,1)	S(1,2)	S(2,2)
400.0MHz	0.625 / -167.384	9.374 / 91.039	0.050 / 52.421	0.322 / -130.145
600.0MHz	0.626 / -177.238	6.323 / 82.918	0.064 / 57.948	0.302 / -142.473
800.0MHz	0.628 / 175.851	4.789 / 76.292	0.079 / 61.058	0.302 / -149.445
1.000GHz	0.649 / 170.275	3.875 / 70.004	0.095 / 62.773	0.306 / -153.914
1.200GHz	0.650 / 168.695	3.267 / 65.804	0.112 / 63.870	0.303 / -159.948
1.400GHz	0.647 / 164.988	2.803 / 61.172	0.130 / 64.064	0.314 / -162.604
1.600GHz	0.660 / 160.649	2.482 / 56.490	0.147 / 63.780	0.327 / -165.301
1.800GHz	0.672 / 158.022	2.220 / 52.086	0.165 / 63.007	0.341 / -167.724
2.000GHz	0.672 / 153.970	2.012 / 47.665	0.183 / 61.969	0.357 / -169.919
2.200GHz	0.674 / 150.723	1.835 / 43.482	0.200 / 60.731	0.374 / -172.009
2.400GHz	0.686 / 146.639	1.689 / 39.942	0.218 / 59.384	0.392 / -173.469
2.600GHz	0.700 / 143.070	1.561 / 36.297	0.236 / 57.765	0.408 / -175.308
2.800GHz	0.703 / 139.691	1.461 / 32.518	0.253 / 56.216	0.429 / -177.053
3.000GHz	0.709 / 135.471	1.369 / 29.558	0.270 / 54.545	0.450 / -178.375

at $V_{CE} = 3\text{ V}$, $I_c = 25\text{ mA}$

freq	S(1,1)	S(2,1)	S(1,2)	S(2,2)
400.0MHz	0.631 / -171.125	9.479 / 89.941	0.047 / 56.410	0.321 / -136.761
600.0MHz	0.635 / 179.816	6.379 / 82.297	0.063 / 61.653	0.307 / -148.114
800.0MHz	0.637 / 174.058	4.829 / 75.999	0.080 / 64.045	0.309 / -154.342
1.000GHz	0.647 / 168.505	3.905 / 70.096	0.097 / 65.199	0.313 / -158.358
1.200GHz	0.654 / 167.362	3.288 / 65.832	0.114 / 65.704	0.311 / -164.259
1.400GHz	0.655 / 163.635	2.824 / 61.336	0.132 / 65.517	0.321 / -166.614
1.600GHz	0.665 / 160.444	2.498 / 56.751	0.150 / 64.723	0.333 / -169.129
1.800GHz	0.675 / 156.527	2.240 / 52.402	0.168 / 63.679	0.347 / -171.352
2.000GHz	0.673 / 152.920	2.030 / 48.148	0.186 / 62.423	0.361 / -173.364
2.200GHz	0.679 / 149.548	1.853 / 44.022	0.205 / 60.959	0.377 / -175.285
2.400GHz	0.688 / 145.976	1.704 / 40.475	0.222 / 59.449	0.394 / -176.578
2.600GHz	0.701 / 142.287	1.578 / 36.751	0.239 / 57.668	0.409 / -178.209
2.800GHz	0.703 / 139.247	1.476 / 33.083	0.257 / 56.011	0.429 / -179.780
3.000GHz	0.708 / 134.720	1.390 / 29.925	0.274 / 54.281	0.449 / 179.032

at $V_{CE} = 3\text{ V}$, $I_c = 30\text{ mA}$

freq	S(1,1)	S(2,1)	S(1,2)	S(2,2)
400.0MHz	0.644 / -174.210	9.501 / 89.140	0.046 / 59.679	0.322 / -141.610
600.0MHz	0.645 / 178.031	6.378 / 81.824	0.063 / 64.056	0.311 / -151.952
800.0MHz	0.642 / 172.428	4.829 / 75.669	0.080 / 66.208	0.315 / -157.668
1.000GHz	0.656 / 167.400	3.913 / 69.867	0.098 / 66.866	0.319 / -161.406
1.200GHz	0.660 / 166.815	3.290 / 65.766	0.116 / 66.984	0.318 / -167.131
1.400GHz	0.664 / 162.991	2.819 / 61.399	0.135 / 66.406	0.327 / -169.318
1.600GHz	0.669 / 159.619	2.499 / 56.852	0.153 / 65.420	0.339 / -171.757
1.800GHz	0.677 / 155.635	2.235 / 52.647	0.171 / 64.189	0.352 / -173.832
2.000GHz	0.676 / 152.156	2.026 / 48.358	0.189 / 62.694	0.366 / -175.759
2.200GHz	0.681 / 148.689	1.851 / 44.337	0.207 / 61.140	0.381 / -177.565
2.400GHz	0.692 / 144.767	1.702 / 40.932	0.225 / 59.492	0.397 / -178.730
2.600GHz	0.703 / 141.943	1.578 / 37.182	0.243 / 57.678	0.411 / 179.745
2.800GHz	0.705 / 138.072	1.484 / 33.729	0.260 / 55.876	0.430 / 178.235
3.000GHz	0.713 / 133.924	1.389 / 30.675	0.277 / 54.104	0.450 / 177.194

THN6501 Series

at $V_{CE} = 3\text{ V}$, $I_c = 35\text{ mA}$

freq	S(1,1)	S(2,1)	S(1,2)	S(2,2)
400.0MHz	0.639 / -177.167	9.448 / 88.546	0.045 / 62.043	0.322 / -145.010
600.0MHz	0.641 / 177.647	6.343 / 81.403	0.063 / 66.041	0.315 / -154.673
800.0MHz	0.647 / 171.572	4.795 / 75.499	0.080 / 67.623	0.319 / -159.966
1.000GHz	0.659 / 167.098	3.885 / 69.751	0.099 / 67.956	0.324 / -163.491
1.200GHz	0.662 / 165.651	3.265 / 65.768	0.117 / 67.870	0.323 / -169.086
1.400GHz	0.665 / 162.598	2.802 / 61.271	0.136 / 67.123	0.332 / -171.172
1.600GHz	0.673 / 158.564	2.481 / 56.792	0.154 / 65.872	0.344 / -173.496
1.800GHz	0.683 / 155.204	2.225 / 52.590	0.173 / 64.448	0.356 / -175.533
2.000GHz	0.682 / 151.741	2.015 / 48.440	0.191 / 62.928	0.370 / -177.355
2.200GHz	0.683 / 148.626	1.839 / 44.404	0.209 / 61.229	0.384 / -179.090
2.400GHz	0.695 / 144.705	1.693 / 41.022	0.227 / 59.526	0.400 / 179.797
2.600GHz	0.708 / 141.248	1.570 / 37.277	0.245 / 57.649	0.413 / 178.333
2.800GHz	0.712 / 137.685	1.477 / 33.881	0.262 / 55.823	0.432 / 176.913
3.000GHz	0.717 / 133.307	1.387 / 30.701	0.279 / 53.932	0.451 / 175.911

at $V_{CE} = 3\text{ V}$, $I_c = 40\text{ mA}$

freq	S(1,1)	S(2,1)	S(1,2)	S(2,2)
400.0MHz	0.647 / -176.721	9.343 / 87.936	0.044 / 64.009	0.323 / -147.831
600.0MHz	0.660 / 176.185	6.256 / 81.014	0.063 / 67.634	0.318 / -156.762
800.0MHz	0.655 / 170.669	4.737 / 75.094	0.081 / 68.784	0.323 / -161.712
1.000GHz	0.667 / 166.738	3.835 / 69.381	0.099 / 68.885	0.327 / -164.978
1.200GHz	0.664 / 164.962	3.225 / 65.524	0.118 / 68.525	0.327 / -170.499
1.400GHz	0.673 / 161.792	2.767 / 61.179	0.137 / 67.551	0.336 / -172.514
1.600GHz	0.681 / 158.044	2.452 / 56.677	0.155 / 66.309	0.347 / -174.752
1.800GHz	0.691 / 154.987	2.193 / 52.574	0.174 / 64.735	0.359 / -176.659
2.000GHz	0.686 / 151.485	1.993 / 48.398	0.193 / 63.127	0.373 / -178.491
2.200GHz	0.688 / 147.693	1.819 / 44.519	0.211 / 61.375	0.388 / 179.806
2.400GHz	0.703 / 144.043	1.673 / 40.979	0.229 / 59.606	0.403 / 178.747
2.600GHz	0.715 / 140.603	1.551 / 37.373	0.247 / 57.717	0.416 / 177.321
2.800GHz	0.714 / 137.419	1.458 / 33.908	0.264 / 55.786	0.434 / 175.948
3.000GHz	0.721 / 132.914	1.372 / 30.866	0.281 / 53.903	0.452 / 174.986

at $V_{CE} = 3\text{ V}$, $I_c = 45\text{ mA}$

freq	S(1,1)	S(2,1)	S(1,2)	S(2,2)
400.0MHz	0.645 / -177.884	9.174 / 87.431	0.044 / 65.832	0.322 / -149.907
600.0MHz	0.662 / 175.129	6.138 / 80.668	0.063 / 68.845	0.318 / -158.337
800.0MHz	0.660 / 169.893	4.647 / 74.809	0.081 / 69.736	0.324 / -162.975
1.000GHz	0.669 / 165.357	3.755 / 69.228	0.099 / 69.563	0.329 / -166.026
1.200GHz	0.675 / 164.128	3.169 / 65.214	0.119 / 69.189	0.329 / -171.419
1.400GHz	0.681 / 161.257	2.717 / 60.886	0.138 / 68.051	0.338 / -173.362
1.600GHz	0.689 / 157.144	2.404 / 56.467	0.156 / 66.666	0.350 / -175.513
1.800GHz	0.693 / 154.040	2.153 / 52.169	0.175 / 65.087	0.362 / -177.390
2.000GHz	0.694 / 150.651	1.957 / 48.157	0.194 / 63.390	0.375 / -179.145
2.200GHz	0.695 / 147.452	1.781 / 44.179	0.212 / 61.544	0.390 / 179.161
2.400GHz	0.705 / 143.702	1.645 / 40.784	0.230 / 59.737	0.405 / 178.132
2.600GHz	0.719 / 139.985	1.522 / 37.298	0.248 / 57.752	0.418 / 176.730
2.800GHz	0.721 / 137.385	1.430 / 33.389	0.265 / 55.814	0.436 / 175.403
3.000GHz	0.726 / 132.934	1.344 / 30.635	0.282 / 53.972	0.454 / 174.434

at $V_{CE} = 3\text{ V}$, $I_c = 50\text{ mA}$

freq	S(1,1)	S(2,1)	S(1,2)	S(2,2)
400.0MHz	0.657 / -179.992	8.867 / 86.887	0.044 / 66.788	0.320 / -151.726
600.0MHz	0.673 / 174.587	5.945 / 80.227	0.062 / 69.811	0.317 / -159.550
800.0MHz	0.669 / 169.247	4.496 / 74.456	0.081 / 70.382	0.323 / -163.818
1.000GHz	0.689 / 164.927	3.630 / 68.571	0.100 / 70.187	0.329 / -166.689
1.200GHz	0.687 / 163.595	3.057 / 64.665	0.119 / 69.616	0.329 / -171.911
1.400GHz	0.693 / 160.408	2.627 / 60.473	0.138 / 68.468	0.339 / -173.697
1.600GHz	0.697 / 157.432	2.321 / 55.982	0.157 / 67.030	0.350 / -175.790
1.800GHz	0.707 / 153.479	2.084 / 51.815	0.176 / 65.397	0.363 / -177.644
2.000GHz	0.704 / 149.945	1.889 / 47.628	0.195 / 63.661	0.377 / -179.374
2.200GHz	0.705 / 146.846	1.728 / 43.599	0.213 / 61.807	0.391 / 179.004
2.400GHz	0.713 / 143.094	1.592 / 40.330	0.231 / 59.930	0.407 / 177.995
2.600GHz	0.723 / 139.903	1.473 / 36.663	0.249 / 57.879	0.420 / 176.573
2.800GHz	0.726 / 136.624	1.384 / 33.239	0.266 / 55.918	0.438 / 175.242
3.000GHz	0.731 / 132.389	1.297 / 30.176	0.283 / 54.009	0.457 / 174.298

THN6501 Series

at $V_{CE} = 6\text{ V}$, $I_c = 3\text{ mA}$

freq	S(1,1)	S(2,1)	S(1,2)	S(2,2)
400.0MHz	0.705 / -114.047	5.588 / 108.671	0.108 / 32.686	0.597 / -63.363
600.0MHz	0.676 / -136.609	4.066 / 93.342	0.114 / 24.720	0.495 / -76.268
800.0MHz	0.664 / -151.819	3.153 / 81.670	0.112 / 21.629	0.453 / -86.100
1.000GHz	0.680 / -162.270	2.594 / 71.885	0.108 / 21.848	0.438 / -94.218
1.200GHz	0.684 / -168.216	2.185 / 64.761	0.103 / 25.417	0.429 / -101.790
1.400GHz	0.692 / -174.658	1.877 / 57.971	0.101 / 30.937	0.439 / -108.610
1.600GHz	0.705 / 179.192	1.655 / 51.115	0.102 / 38.342	0.455 / -115.639
1.800GHz	0.719 / 173.524	1.475 / 45.369	0.108 / 45.948	0.477 / -122.166
2.000GHz	0.724 / 168.488	1.322 / 39.667	0.119 / 52.808	0.500 / -128.550
2.200GHz	0.729 / 163.484	1.195 / 34.656	0.135 / 57.833	0.525 / -134.639
2.400GHz	0.749 / 158.244	1.083 / 30.570	0.154 / 61.000	0.550 / -139.917
2.600GHz	0.768 / 153.476	0.990 / 26.359	0.176 / 62.436	0.573 / -145.394
2.800GHz	0.776 / 148.575	0.915 / 23.011	0.199 / 62.687	0.600 / -150.418
3.000GHz	0.783 / 143.249	0.840 / 20.449	0.223 / 62.158	0.627 / -154.788

at $V_{CE} = 6\text{ V}$, $I_c = 5\text{ mA}$

freq	S(1,1)	S(2,1)	S(1,2)	S(2,2)
400.0MHz	0.649 / -130.737	7.063 / 103.248	0.087 / 33.791	0.484 / -77.980
600.0MHz	0.638 / -149.996	4.976 / 90.157	0.091 / 30.686	0.397 / -91.478
800.0MHz	0.636 / -162.200	3.823 / 80.336	0.094 / 31.823	0.365 / -101.349
1.000GHz	0.649 / -171.694	3.117 / 71.717	0.096 / 35.061	0.355 / -108.791
1.200GHz	0.656 / -176.244	2.629 / 65.629	0.100 / 39.914	0.346 / -115.959
1.400GHz	0.658 / 178.980	2.259 / 59.495	0.107 / 44.794	0.358 / -121.650
1.600GHz	0.670 / 173.195	1.990 / 53.570	0.115 / 49.512	0.374 / -127.450
1.800GHz	0.684 / 168.821	1.780 / 48.255	0.127 / 53.455	0.394 / -132.801
2.000GHz	0.691 / 164.188	1.606 / 42.903	0.141 / 56.476	0.418 / -137.841
2.200GHz	0.699 / 159.546	1.453 / 38.186	0.158 / 58.586	0.442 / -142.749
2.400GHz	0.713 / 155.080	1.328 / 33.903	0.175 / 59.732	0.467 / -146.936
2.600GHz	0.724 / 150.817	1.218 / 29.824	0.195 / 59.969	0.491 / -151.313
2.800GHz	0.738 / 146.358	1.133 / 25.911	0.215 / 59.706	0.519 / -155.400
3.000GHz	0.743 / 141.880	1.050 / 22.760	0.236 / 58.929	0.546 / -158.917

at $V_{CE} = 6\text{ V}$, $I_c = 7\text{ mA}$

freq	S(1,1)	S(2,1)	S(1,2)	S(2,2)
400.0MHz	0.628 / -140.044	7.904 / 100.263	0.074 / 35.856	0.426 / -88.687
600.0MHz	0.631 / -157.001	5.495 / 88.429	0.080 / 36.312	0.352 / -102.995
800.0MHz	0.619 / -168.740	4.193 / 79.573	0.086 / 39.337	0.328 / -112.668
1.000GHz	0.639 / -176.854	3.416 / 71.720	0.093 / 43.421	0.322 / -119.785
1.200GHz	0.641 / -179.381	2.875 / 66.030	0.101 / 47.818	0.314 / -126.689
1.400GHz	0.650 / 174.791	2.466 / 60.408	0.112 / 51.521	0.326 / -131.657
1.600GHz	0.654 / 170.087	2.183 / 54.783	0.124 / 54.597	0.341 / -136.651
1.800GHz	0.672 / 165.665	1.948 / 49.799	0.138 / 56.718	0.360 / -141.077
2.000GHz	0.678 / 161.505	1.760 / 44.727	0.154 / 58.329	0.382 / -145.323
2.200GHz	0.683 / 157.580	1.599 / 39.981	0.170 / 59.128	0.405 / -149.400
2.400GHz	0.696 / 153.068	1.465 / 35.888	0.188 / 59.442	0.429 / -152.812
2.600GHz	0.711 / 148.608	1.351 / 31.772	0.206 / 59.054	0.451 / -156.390
2.800GHz	0.722 / 145.409	1.254 / 27.891	0.225 / 58.397	0.478 / -159.836
3.000GHz	0.732 / 140.213	1.167 / 25.010	0.244 / 57.483	0.504 / -162.765

at $V_{CE} = 6\text{ V}$, $I_c = 10\text{ mA}$

freq	S(1,1)	S(2,1)	S(1,2)	S(2,2)
400.0MHz	0.618 / -150.356	8.714 / 97.133	0.063 / 40.459	0.377 / -101.358
600.0MHz	0.619 / -164.923	5.964 / 86.783	0.072 / 43.746	0.321 / -116.003
800.0MHz	0.616 / -174.746	4.542 / 78.728	0.081 / 47.798	0.305 / -125.502
1.000GHz	0.631 / 178.982	3.683 / 71.585	0.092 / 51.581	0.303 / -131.951
1.200GHz	0.644 / 176.246	3.108 / 66.568	0.105 / 54.717	0.296 / -138.724
1.400GHz	0.644 / 171.855	2.664 / 61.334	0.118 / 57.121	0.308 / -142.827
1.600GHz	0.650 / 167.108	2.351 / 56.026	0.132 / 58.668	0.322 / -146.936
1.800GHz	0.663 / 163.036	2.109 / 51.172	0.148 / 59.562	0.339 / -150.570
2.000GHz	0.664 / 158.917	1.905 / 46.389	0.165 / 59.954	0.359 / -153.917
2.200GHz	0.670 / 155.118	1.738 / 42.067	0.182 / 59.803	0.380 / -157.214
2.400GHz	0.683 / 150.631	1.592 / 38.124	0.199 / 59.369	0.402 / -159.801
2.600GHz	0.698 / 147.091	1.470 / 34.049	0.217 / 58.503	0.422 / -162.666
2.800GHz	0.702 / 143.654	1.369 / 30.292	0.235 / 57.416	0.447 / -165.406
3.000GHz	0.711 / 139.180	1.282 / 27.166	0.253 / 56.206	0.471 / -167.680

THN6501 Series

at $V_{CE} = 6\text{ V}$, $I_C = 15\text{ mA}$

freq	S(1,1)	S(2,1)	S(1,2)	S(2,2)
400.0MHz	0.602 / -160.189	9.397 / 94.432	0.054 / 47.189	0.344 / -115.170
600.0MHz	0.616 / -171.421	6.387 / 85.316	0.066 / 52.126	0.306 / -129.457
800.0MHz	0.609 / -179.592	4.846 / 78.083	0.079 / 55.942	0.298 / -138.065
1.000GHz	0.623 / 174.242	3.932 / 71.473	0.093 / 58.559	0.299 / -143.768
1.200GHz	0.635 / 172.495	3.311 / 66.881	0.108 / 60.658	0.294 / -150.309
1.400GHz	0.639 / 168.661	2.836 / 62.024	0.124 / 61.602	0.304 / -153.679
1.600GHz	0.643 / 164.403	2.511 / 57.100	0.140 / 61.984	0.317 / -157.078
1.800GHz	0.659 / 160.101	2.249 / 52.503	0.158 / 61.781	0.332 / -160.001
2.000GHz	0.656 / 156.661	2.035 / 47.928	0.175 / 61.335	0.349 / -162.671
2.200GHz	0.661 / 152.987	1.853 / 43.736	0.192 / 60.486	0.367 / -165.266
2.400GHz	0.674 / 148.934	1.708 / 40.041	0.209 / 59.477	0.387 / -167.134
2.600GHz	0.690 / 145.476	1.574 / 36.260	0.227 / 58.174	0.404 / -169.361
2.800GHz	0.696 / 141.949	1.477 / 32.316	0.244 / 56.754	0.426 / -171.494
3.000GHz	0.701 / 137.332	1.380 / 29.188	0.262 / 55.277	0.449 / -173.171

at $V_{CE} = 6\text{ V}$, $I_C = 20\text{ mA}$

freq	S(1,1)	S(2,1)	S(1,2)	S(2,2)
400.0MHz	0.599 / -165.093	9.772 / 92.896	0.050 / 52.426	0.332 / -123.767
600.0MHz	0.613 / -175.348	6.613 / 84.407	0.064 / 57.548	0.304 / -137.259
800.0MHz	0.611 / 177.314	5.010 / 77.647	0.079 / 60.580	0.300 / -145.151
1.000GHz	0.627 / 171.942	4.059 / 71.403	0.094 / 62.685	0.302 / -150.251
1.200GHz	0.628 / 170.249	3.415 / 67.035	0.111 / 63.702	0.297 / -156.652
1.400GHz	0.638 / 166.304	2.930 / 62.446	0.128 / 64.026	0.307 / -159.655
1.600GHz	0.643 / 162.392	2.591 / 57.678	0.145 / 63.714	0.319 / -162.667
1.800GHz	0.658 / 158.828	2.324 / 53.286	0.162 / 63.021	0.333 / -165.293
2.000GHz	0.651 / 155.018	2.108 / 48.864	0.180 / 62.063	0.349 / -167.648
2.200GHz	0.658 / 151.632	1.917 / 44.590	0.198 / 60.861	0.365 / -169.904
2.400GHz	0.669 / 147.743	1.764 / 41.091	0.215 / 59.593	0.383 / -171.442
2.600GHz	0.683 / 144.206	1.634 / 37.389	0.232 / 58.005	0.399 / -173.355
2.800GHz	0.689 / 140.559	1.530 / 33.525	0.250 / 56.515	0.420 / -175.215
3.000GHz	0.695 / 136.894	1.437 / 30.429	0.267 / 54.910	0.441 / -176.582

at $V_{CE} = 6\text{ V}$, $I_C = 25\text{ mA}$

freq	S(1,1)	S(2,1)	S(1,2)	S(2,2)
400.0MHz	0.605 / -168.818	9.983 / 92.074	0.047 / 56.620	0.327 / -129.252
600.0MHz	0.615 / -178.088	6.736 / 83.885	0.063 / 60.959	0.304 / -142.145
800.0MHz	0.617 / 175.207	5.101 / 77.369	0.079 / 63.754	0.303 / -149.446
1.000GHz	0.627 / 170.044	4.138 / 71.358	0.096 / 64.956	0.305 / -154.175
1.200GHz	0.630 / 168.222	3.477 / 67.135	0.113 / 65.610	0.301 / -160.505
1.400GHz	0.635 / 164.967	2.987 / 62.591	0.130 / 65.490	0.311 / -163.249
1.600GHz	0.644 / 161.515	2.640 / 57.905	0.148 / 64.737	0.322 / -166.073
1.800GHz	0.652 / 157.631	2.368 / 53.732	0.166 / 63.780	0.335 / -168.521
2.000GHz	0.653 / 153.825	2.146 / 49.267	0.184 / 62.623	0.350 / -170.685
2.200GHz	0.656 / 150.606	1.954 / 45.263	0.201 / 61.183	0.365 / -172.783
2.400GHz	0.666 / 147.166	1.799 / 41.622	0.219 / 59.681	0.382 / -174.182
2.600GHz	0.681 / 144.019	1.668 / 37.922	0.236 / 58.060	0.397 / -175.924
2.800GHz	0.693 / 140.292	1.561 / 34.340	0.253 / 56.446	0.417 / -177.588
3.000GHz	0.696 / 135.803	1.461 / 31.317	0.270 / 54.727	0.437 / -178.813

at $V_{CE} = 6\text{ V}$, $I_C = 30\text{ mA}$

freq	S(1,1)	S(2,1)	S(1,2)	S(2,2)
400.0MHz	0.600 / -171.879	10.114 / 91.333	0.046 / 59.445	0.324 / -133.155
600.0MHz	0.613 / -179.832	6.820 / 83.536	0.062 / 63.640	0.305 / -145.349
800.0MHz	0.615 / 174.097	5.160 / 77.160	0.079 / 65.741	0.305 / -152.245
1.000GHz	0.635 / 169.395	4.183 / 71.297	0.096 / 66.593	0.308 / -156.736
1.200GHz	0.631 / 167.644	3.519 / 67.037	0.114 / 66.980	0.305 / -162.940
1.400GHz	0.637 / 164.468	3.019 / 62.726	0.132 / 66.306	0.314 / -165.580
1.600GHz	0.639 / 160.547	2.670 / 58.125	0.150 / 65.474	0.325 / -168.277
1.800GHz	0.659 / 157.035	2.390 / 53.834	0.168 / 64.320	0.337 / -170.604
2.000GHz	0.653 / 153.534	2.170 / 49.708	0.186 / 62.953	0.351 / -172.666
2.200GHz	0.658 / 150.441	1.976 / 45.542	0.204 / 61.392	0.366 / -174.670
2.400GHz	0.668 / 146.061	1.825 / 42.139	0.221 / 59.871	0.383 / -175.978
2.600GHz	0.683 / 143.107	1.681 / 38.366	0.239 / 58.079	0.397 / -177.558
2.800GHz	0.684 / 139.588	1.580 / 34.619	0.255 / 56.335	0.416 / -179.153
3.000GHz	0.691 / 135.621	1.486 / 31.784	0.273 / 54.568	0.435 / -179.684

THN6501 Series

at $V_{CE} = 6\text{ V}$, $I_C = 40\text{ mA}$

freq	S(1,1)	S(2,1)	S(1,2)	S(2,2)
400.0MHz	0.612 / -174.794	10.229 / 90.367	0.045 / 63.768	0.320 / -138.041
600.0MHz	0.625 / 178.281	6.880 / 82.909	0.062 / 66.953	0.306 / -149.304
800.0MHz	0.622 / 172.334	5.210 / 76.749	0.079 / 68.594	0.308 / -155.634
1.000GHz	0.628 / 167.842	4.214 / 71.064	0.097 / 68.859	0.311 / -159.675
1.200GHz	0.630 / 166.111	3.553 / 67.118	0.116 / 68.646	0.308 / -165.748
1.400GHz	0.641 / 163.512	3.039 / 62.668	0.134 / 67.671	0.317 / -168.249
1.600GHz	0.646 / 159.468	2.693 / 58.144	0.152 / 66.536	0.328 / -170.768
1.800GHz	0.659 / 155.902	2.411 / 54.102	0.171 / 65.133	0.340 / -172.935
2.000GHz	0.657 / 152.849	2.186 / 49.696	0.189 / 63.511	0.353 / -174.953
2.200GHz	0.661 / 149.393	1.998 / 45.840	0.207 / 61.811	0.368 / -176.811
2.400GHz	0.669 / 145.588	1.840 / 42.251	0.224 / 60.103	0.383 / -177.993
2.600GHz	0.683 / 142.191	1.703 / 38.668	0.242 / 58.234	0.396 / -179.510
2.800GHz	0.690 / 138.906	1.598 / 35.079	0.259 / 56.443	0.415 / 179.013
3.000GHz	0.692 / 134.426	1.495 / 32.184	0.276 / 54.524	0.433 / 178.008

at $V_{CE} = 6\text{ V}$, $I_C = 50\text{ mA}$

freq	S(1,1)	S(2,1)	S(1,2)	S(2,2)
400.0MHz	0.618 / -176.740	10.217 / 89.718	0.043 / 66.447	0.316 / -140.863
600.0MHz	0.623 / 176.573	6.863 / 82.421	0.061 / 69.331	0.305 / -151.390
800.0MHz	0.622 / 171.216	5.194 / 76.505	0.079 / 70.351	0.307 / -157.337
1.000GHz	0.635 / 166.797	4.202 / 70.809	0.098 / 70.004	0.311 / -161.113
1.200GHz	0.641 / 165.456	3.538 / 66.887	0.117 / 69.715	0.309 / -167.056
1.400GHz	0.643 / 162.520	3.032 / 62.550	0.135 / 68.553	0.318 / -169.425
1.600GHz	0.651 / 158.799	2.683 / 58.134	0.154 / 67.247	0.328 / -171.852
1.800GHz	0.658 / 155.102	2.404 / 53.980	0.172 / 65.637	0.340 / -173.965
2.000GHz	0.662 / 152.050	2.181 / 49.818	0.191 / 63.962	0.354 / -175.859
2.200GHz	0.662 / 148.969	1.989 / 45.783	0.209 / 62.151	0.368 / -177.666
2.400GHz	0.673 / 145.237	1.833 / 42.230	0.226 / 60.355	0.383 / -178.806
2.600GHz	0.690 / 141.458	1.695 / 38.725	0.244 / 58.460	0.396 / 179.713
2.800GHz	0.686 / 138.500	1.591 / 34.988	0.260 / 56.530	0.414 / 178.279
3.000GHz	0.697 / 134.216	1.492 / 31.920	0.278 / 54.656	0.432 / 177.295

at $V_{CE} = 6\text{ V}$, $I_C = 60\text{ mA}$

freq	S(1,1)	S(2,1)	S(1,2)	S(2,2)
400.0MHz	0.626 / -179.134	10.093 / 89.155	0.043 / 68.447	0.310 / -142.464
600.0MHz	0.635 / 175.612	6.775 / 82.149	0.061 / 71.167	0.301 / -152.491
800.0MHz	0.631 / 170.143	5.124 / 76.129	0.080 / 71.483	0.304 / -158.035
1.000GHz	0.646 / 165.894	4.145 / 70.461	0.098 / 71.241	0.308 / -161.642
1.200GHz	0.653 / 165.059	3.489 / 66.387	0.117 / 70.477	0.307 / -167.499
1.400GHz	0.649 / 161.964	2.992 / 62.160	0.136 / 69.326	0.316 / -169.696
1.600GHz	0.654 / 158.469	2.654 / 57.792	0.154 / 67.834	0.327 / -172.040
1.800GHz	0.671 / 155.013	2.373 / 53.584	0.173 / 66.134	0.339 / -174.067
2.000GHz	0.665 / 151.373	2.150 / 49.417	0.191 / 64.401	0.352 / -175.923
2.200GHz	0.664 / 148.413	1.961 / 45.352	0.210 / 62.512	0.367 / -177.698
2.400GHz	0.681 / 144.380	1.809 / 41.993	0.227 / 60.688	0.382 / -178.836
2.600GHz	0.690 / 141.593	1.674 / 38.097	0.245 / 58.712	0.395 / 179.710
2.800GHz	0.699 / 138.080	1.569 / 34.671	0.261 / 56.788	0.414 / 178.284
3.000GHz	0.704 / 133.754	1.475 / 31.428	0.279 / 54.827	0.432 / 177.311

at $V_{CE} = 6\text{ V}$, $I_C = 70\text{ mA}$

freq	S(1,1)	S(2,1)	S(1,2)	S(2,2)
400.0MHz	0.635 / -179.667	9.836 / 88.552	0.042 / 69.852	0.301 / -143.292
600.0MHz	0.640 / 174.983	6.601 / 81.552	0.061 / 72.044	0.293 / -152.817
800.0MHz	0.640 / 169.393	4.991 / 75.535	0.079 / 72.382	0.298 / -158.030
1.000GHz	0.656 / 166.032	4.038 / 69.892	0.098 / 71.866	0.303 / -161.425
1.200GHz	0.663 / 164.151	3.396 / 65.843	0.117 / 71.195	0.302 / -167.048
1.400GHz	0.666 / 161.277	2.910 / 61.550	0.136 / 69.890	0.311 / -169.143
1.600GHz	0.667 / 157.684	2.579 / 57.021	0.154 / 68.342	0.323 / -171.408
1.800GHz	0.679 / 154.618	2.310 / 52.838	0.173 / 66.690	0.336 / -173.409
2.000GHz	0.676 / 151.257	2.094 / 48.570	0.192 / 64.897	0.350 / -175.194
2.200GHz	0.680 / 147.849	1.910 / 44.600	0.210 / 63.039	0.365 / -176.970
2.400GHz	0.688 / 143.997	1.764 / 41.088	0.228 / 61.109	0.381 / -178.106
2.600GHz	0.697 / 141.044	1.633 / 37.329	0.245 / 59.079	0.395 / -179.562
2.800GHz	0.705 / 137.537	1.528 / 33.661	0.262 / 57.126	0.414 / 178.977
3.000GHz	0.714 / 133.218	1.432 / 30.661	0.280 / 55.153	0.433 / 177.958

THN6501 Series

at $V_{CE} = 8\text{ V}$, $I_c = 3\text{ mA}$

freq	S(1,1)	S(2,1)	S(1,2)	S(2,2)
400.0MHz	0.713 / -113.258	5.671 / 108.784	0.107 / 32.859	0.600 / -62.001
600.0MHz	0.684 / -135.865	4.124 / 93.513	0.113 / 25.014	0.497 / -74.497
800.0MHz	0.668 / -150.863	3.204 / 81.896	0.111 / 21.824	0.454 / -84.019
1.000GHz	0.679 / -162.200	2.637 / 72.146	0.107 / 22.054	0.438 / -92.115
1.200GHz	0.682 / -167.702	2.226 / 65.001	0.103 / 25.363	0.428 / -99.457
1.400GHz	0.691 / -174.836	1.910 / 58.249	0.101 / 30.883	0.437 / -106.325
1.600GHz	0.703 / 179.221	1.682 / 51.651	0.101 / 38.053	0.453 / -113.272
1.800GHz	0.718 / 173.502	1.503 / 45.851	0.107 / 46.004	0.473 / -119.908
2.000GHz	0.724 / 168.379	1.348 / 40.181	0.118 / 52.830	0.497 / -126.247
2.200GHz	0.732 / 163.450	1.219 / 35.083	0.133 / 57.903	0.520 / -132.426
2.400GHz	0.747 / 158.120	1.102 / 30.800	0.153 / 61.219	0.546 / -137.748
2.600GHz	0.761 / 153.823	1.008 / 26.718	0.174 / 62.639	0.568 / -143.358
2.800GHz	0.774 / 148.943	0.933 / 22.978	0.197 / 63.057	0.595 / -148.467
3.000GHz	0.783 / 143.773	0.861 / 20.235	0.221 / 62.622	0.622 / -152.918

at $V_{CE} = 8\text{ V}$, $I_c = 5\text{ mA}$

freq	S(1,1)	S(2,1)	S(1,2)	S(2,2)
400.0MHz	0.657 / -129.276	7.139 / 103.613	0.086 / 33.667	0.489 / -75.713
600.0MHz	0.644 / -149.218	5.028 / 90.415	0.091 / 30.489	0.399 / -88.879
800.0MHz	0.635 / -161.886	3.868 / 80.525	0.093 / 31.497	0.365 / -98.390
1.000GHz	0.647 / -170.750	3.156 / 71.803	0.096 / 34.645	0.354 / -105.897
1.200GHz	0.651 / -175.598	2.664 / 65.792	0.099 / 39.321	0.344 / -112.910
1.400GHz	0.665 / 178.995	2.285 / 59.792	0.105 / 44.338	0.356 / -118.608
1.600GHz	0.670 / 173.787	2.023 / 53.642	0.114 / 49.164	0.371 / -124.626
1.800GHz	0.690 / 168.772	1.803 / 48.295	0.125 / 53.198	0.391 / -129.987
2.000GHz	0.687 / 164.169	1.627 / 43.156	0.139 / 56.564	0.413 / -135.287
2.200GHz	0.700 / 159.952	1.475 / 38.301	0.155 / 58.706	0.437 / -140.304
2.400GHz	0.712 / 154.924	1.347 / 34.053	0.173 / 59.992	0.463 / -144.511
2.600GHz	0.728 / 150.923	1.234 / 30.023	0.193 / 60.258	0.486 / -149.076
2.800GHz	0.742 / 146.900	1.146 / 25.961	0.212 / 60.076	0.514 / -153.311
3.000GHz	0.749 / 141.801	1.063 / 22.577	0.233 / 59.369	0.542 / -156.917

at $V_{CE} = 8\text{ V}$, $I_c = 7\text{ mA}$

freq	S(1,1)	S(2,1)	S(1,2)	S(2,2)
400.0MHz	0.618 / -138.774	8.064 / 100.244	0.073 / 35.965	0.423 / -87.076
600.0MHz	0.628 / -156.843	5.589 / 88.488	0.080 / 36.325	0.348 / -100.841
800.0MHz	0.622 / -168.070	4.272 / 79.594	0.085 / 39.441	0.322 / -110.481
1.000GHz	0.636 / -176.103	3.482 / 71.759	0.092 / 43.442	0.316 / -117.523
1.200GHz	0.647 / 179.594	2.928 / 66.252	0.100 / 47.924	0.307 / -124.433
1.400GHz	0.648 / 175.088	2.513 / 60.658	0.111 / 51.544	0.318 / -129.332
1.600GHz	0.658 / 170.569	2.219 / 55.023	0.123 / 54.618	0.334 / -134.364
1.800GHz	0.674 / 165.650	1.990 / 50.002	0.137 / 56.841	0.352 / -138.935
2.000GHz	0.672 / 161.647	1.795 / 44.942	0.152 / 58.440	0.374 / -143.224
2.200GHz	0.680 / 157.788	1.628 / 40.192	0.168 / 59.316	0.396 / -147.424
2.400GHz	0.697 / 153.160	1.493 / 36.210	0.186 / 59.648	0.421 / -150.863
2.600GHz	0.713 / 149.142	1.370 / 32.056	0.204 / 59.272	0.443 / -154.593
2.800GHz	0.722 / 145.142	1.283 / 28.119	0.223 / 58.648	0.470 / -158.133
3.000GHz	0.723 / 140.352	1.194 / 24.812	0.242 / 57.635	0.496 / -161.101

at $V_{CE} = 8\text{ V}$, $I_c = 10\text{ mA}$

freq	S(1,1)	S(2,1)	S(1,2)	S(2,2)
400.0MHz	0.603 / -149.262	8.830 / 97.320	0.063 / 40.400	0.374 / -98.842
600.0MHz	0.614 / -164.131	6.050 / 86.854	0.071 / 43.143	0.316 / -113.228
800.0MHz	0.615 / -174.105	4.608 / 78.784	0.081 / 47.201	0.299 / -122.591
1.000GHz	0.626 / 179.352	3.743 / 71.586	0.091 / 51.028	0.296 / -129.222
1.200GHz	0.640 / 176.617	3.148 / 66.556	0.103 / 54.467	0.288 / -135.871
1.400GHz	0.635 / 171.712	2.706 / 61.359	0.117 / 56.877	0.299 / -140.050
1.600GHz	0.645 / 166.783	2.396 / 56.104	0.131 / 58.629	0.314 / -144.296
1.800GHz	0.662 / 162.912	2.140 / 51.281	0.146 / 59.477	0.331 / -148.024
2.000GHz	0.662 / 159.101	1.939 / 46.523	0.162 / 60.001	0.351 / -151.549
2.200GHz	0.666 / 155.449	1.762 / 42.028	0.179 / 59.926	0.371 / -154.935
2.400GHz	0.682 / 151.077	1.616 / 38.156	0.197 / 59.586	0.394 / -157.603
2.600GHz	0.693 / 147.232	1.492 / 34.005	0.214 / 58.698	0.414 / -160.567
2.800GHz	0.703 / 143.809	1.391 / 30.424	0.232 / 57.674	0.439 / -163.462
3.000GHz	0.713 / 138.704	1.302 / 27.172	0.251 / 56.511	0.464 / -165.834

THN6501 Series

at $V_{CE} = 8 \text{ V}$, $I_C = 15 \text{ mA}$

freq	S(1,1)	S(2,1)	S(1,2)	S(2,2)
400.0MHz	0.605 / -158.571	9.521 / 94.586	0.054 / 46.313	0.338 / -112.392
600.0MHz	0.613 / -170.709	6.472 / 85.339	0.066 / 51.407	0.298 / -126.579
800.0MHz	0.611 / -178.964	4.913 / 78.025	0.078 / 55.366	0.289 / -135.272
1.000GHz	0.624 / 174.594	3.986 / 71.368	0.092 / 58.201	0.289 / -141.063
1.200GHz	0.626 / 172.697	3.354 / 66.739	0.107 / 60.368	0.283 / -147.632
1.400GHz	0.636 / 168.857	2.874 / 61.988	0.123 / 61.387	0.293 / -151.048
1.600GHz	0.641 / 163.824	2.545 / 56.989	0.139 / 61.859	0.306 / -154.511
1.800GHz	0.653 / 160.125	2.282 / 52.493	0.155 / 61.803	0.321 / -157.524
2.000GHz	0.652 / 156.498	2.060 / 48.016	0.172 / 61.377	0.339 / -160.278
2.200GHz	0.657 / 152.938	1.882 / 43.603	0.190 / 60.573	0.357 / -162.956
2.400GHz	0.671 / 149.026	1.732 / 39.896	0.207 / 59.616	0.377 / -164.943
2.600GHz	0.685 / 145.511	1.594 / 35.948	0.224 / 58.389	0.396 / -167.247
2.800GHz	0.689 / 141.726	1.499 / 32.180	0.242 / 56.984	0.418 / -169.522
3.000GHz	0.694 / 136.958	1.398 / 29.019	0.260 / 55.569	0.441 / -171.306

at $V_{CE} = 8 \text{ V}$, $I_C = 20 \text{ mA}$

freq	S(1,1)	S(2,1)	S(1,2)	S(2,2)
400.0MHz	0.600 / -164.771	9.887 / 92.981	0.050 / 51.526	0.324 / -120.833
600.0MHz	0.606 / -174.493	6.700 / 84.402	0.063 / 56.665	0.293 / -134.462
800.0MHz	0.609 / 177.766	5.076 / 77.620	0.078 / 60.139	0.288 / -142.495
1.000GHz	0.619 / 171.398	4.111 / 71.335	0.093 / 62.117	0.290 / -147.630
1.200GHz	0.624 / 170.456	3.463 / 66.924	0.110 / 63.389	0.285 / -154.109
1.400GHz	0.635 / 166.689	2.969 / 62.299	0.126 / 63.795	0.295 / -157.143
1.600GHz	0.638 / 162.514	2.626 / 57.465	0.143 / 63.624	0.307 / -160.218
1.800GHz	0.649 / 158.975	2.353 / 53.213	0.160 / 62.996	0.321 / -162.846
2.000GHz	0.647 / 155.352	2.133 / 48.711	0.178 / 62.146	0.337 / -165.304
2.200GHz	0.656 / 151.651	1.946 / 44.554	0.195 / 61.035	0.354 / -167.634
2.400GHz	0.669 / 147.734	1.789 / 40.771	0.213 / 59.812	0.373 / -169.260
2.600GHz	0.684 / 143.921	1.657 / 37.209	0.230 / 58.296	0.389 / -171.272
2.800GHz	0.685 / 140.690	1.551 / 33.373	0.247 / 56.728	0.411 / -173.196
3.000GHz	0.690 / 136.426	1.457 / 30.230	0.264 / 55.175	0.432 / -174.705

at $V_{CE} = 8 \text{ V}$, $I_C = 25 \text{ mA}$

freq	S(1,1)	S(2,1)	S(1,2)	S(2,2)
400.0MHz	0.605 / -167.685	10.102 / 91.989	0.047 / 55.077	0.317 / -126.261
600.0MHz	0.605 / -177.024	6.826 / 83.971	0.062 / 60.172	0.292 / -139.243
800.0MHz	0.608 / 175.758	5.169 / 77.397	0.078 / 63.082	0.290 / -146.702
1.000GHz	0.625 / 170.385	4.186 / 71.268	0.094 / 64.398	0.292 / -151.555
1.200GHz	0.627 / 169.386	3.522 / 66.892	0.111 / 65.261	0.288 / -157.877
1.400GHz	0.630 / 164.893	3.019 / 62.481	0.129 / 65.164	0.298 / -160.694
1.600GHz	0.640 / 161.800	2.675 / 57.741	0.146 / 64.661	0.309 / -163.578
1.800GHz	0.656 / 158.124	2.394 / 53.527	0.163 / 63.736	0.323 / -166.029
2.000GHz	0.649 / 154.235	2.175 / 49.082	0.181 / 62.698	0.338 / -168.268
2.200GHz	0.655 / 150.753	1.977 / 45.074	0.199 / 61.362	0.354 / -170.415
2.400GHz	0.666 / 147.155	1.822 / 41.369	0.216 / 59.954	0.372 / -171.884
2.600GHz	0.681 / 143.396	1.682 / 37.704	0.233 / 58.358	0.387 / -173.739
2.800GHz	0.684 / 140.267	1.581 / 33.997	0.250 / 56.662	0.407 / -175.485
3.000GHz	0.691 / 136.060	1.485 / 30.981	0.268 / 55.005	0.428 / -176.840

at $V_{CE} = 8 \text{ V}$, $I_C = 30 \text{ mA}$

freq	S(1,1)	S(2,1)	S(1,2)	S(2,2)
400.0MHz	0.586 / -171.048	10.226 / 91.439	0.046 / 58.106	0.313 / -129.926
600.0MHz	0.610 / -179.484	6.897 / 83.514	0.062 / 62.953	0.292 / -142.387
800.0MHz	0.608 / 174.636	5.225 / 77.103	0.078 / 65.156	0.292 / -149.482
1.000GHz	0.626 / 169.803	4.231 / 71.114	0.095 / 66.120	0.294 / -154.063
1.200GHz	0.630 / 168.018	3.557 / 66.955	0.112 / 66.538	0.291 / -160.365
1.400GHz	0.637 / 164.562	3.053 / 62.523	0.130 / 66.225	0.300 / -162.980
1.600GHz	0.635 / 160.456	2.702 / 57.961	0.148 / 65.476	0.311 / -165.660
1.800GHz	0.653 / 157.221	2.423 / 53.692	0.166 / 64.390	0.324 / -168.096
2.000GHz	0.651 / 153.876	2.191 / 49.298	0.183 / 63.070	0.339 / -170.201
2.200GHz	0.651 / 150.636	1.999 / 45.343	0.201 / 61.565	0.354 / -172.224
2.400GHz	0.668 / 146.295	1.841 / 41.792	0.219 / 60.126	0.371 / -173.605
2.600GHz	0.679 / 143.299	1.701 / 38.107	0.236 / 58.397	0.386 / -175.334
2.800GHz	0.682 / 140.005	1.598 / 34.331	0.253 / 56.628	0.406 / -176.999
3.000GHz	0.688 / 136.281	1.501 / 31.122	0.270 / 54.968	0.425 / -178.218

THN6501 Series

at $V_{CE} = 8\text{ V}$, $I_c = 40\text{ mA}$

freq	S(1,1)	S(2,1)	S(1,2)	S(2,2)
400.0MHz	0.609 / -173.988	10.319 / 90.502	0.044 / 62.594	0.309 / -134.220
600.0MHz	0.616 / 178.802	6.955 / 83.028	0.061 / 66.296	0.292 / -145.960
800.0MHz	0.617 / 172.900	5.264 / 76.735	0.078 / 68.023	0.293 / -152.486
1.000GHz	0.629 / 168.297	4.259 / 70.868	0.096 / 68.321	0.296 / -156.757
1.200GHz	0.637 / 166.855	3.582 / 66.721	0.114 / 68.385	0.293 / -162.894
1.400GHz	0.635 / 163.660	3.075 / 62.556	0.132 / 67.635	0.302 / -165.352
1.600GHz	0.644 / 159.872	2.721 / 57.992	0.150 / 66.514	0.313 / -167.947
1.800GHz	0.653 / 156.421	2.437 / 53.820	0.168 / 65.169	0.325 / -170.176
2.000GHz	0.654 / 153.062	2.207 / 49.598	0.186 / 63.691	0.339 / -172.189
2.200GHz	0.656 / 149.439	2.015 / 45.476	0.204 / 62.041	0.354 / -174.132
2.400GHz	0.669 / 145.703	1.857 / 42.015	0.222 / 60.432	0.371 / -175.371
2.600GHz	0.673 / 142.301	1.718 / 38.140	0.239 / 58.474	0.385 / -176.963
2.800GHz	0.685 / 139.594	1.609 / 34.653	0.256 / 56.737	0.404 / -178.559
3.000GHz	0.695 / 134.904	1.514 / 31.555	0.273 / 54.946	0.423 / -179.709

at $V_{CE} = 8\text{ V}$, $I_c = 50\text{ mA}$

freq	S(1,1)	S(2,1)	S(1,2)	S(2,2)
400.0MHz	0.607 / -175.843	10.308 / 89.997	0.044 / 65.722	0.304 / -136.249
600.0MHz	0.621 / 177.233	6.943 / 82.671	0.061 / 68.573	0.289 / -147.517
800.0MHz	0.618 / 171.785	5.251 / 76.546	0.078 / 69.722	0.291 / -153.716
1.000GHz	0.634 / 167.019	4.251 / 70.684	0.096 / 69.849	0.295 / -157.714
1.200GHz	0.635 / 166.278	3.574 / 66.610	0.114 / 69.437	0.292 / -163.808
1.400GHz	0.637 / 162.561	3.069 / 62.396	0.133 / 68.527	0.301 / -166.198
1.600GHz	0.650 / 158.920	2.712 / 57.815	0.151 / 67.289	0.312 / -168.664
1.800GHz	0.657 / 155.553	2.426 / 53.739	0.170 / 65.809	0.325 / -170.832
2.000GHz	0.655 / 152.618	2.204 / 49.398	0.188 / 64.169	0.339 / -172.824
2.200GHz	0.657 / 148.753	2.011 / 45.413	0.206 / 62.477	0.354 / -174.680
2.400GHz	0.671 / 145.325	1.851 / 41.841	0.223 / 60.723	0.370 / -175.898
2.600GHz	0.677 / 141.870	1.716 / 38.171	0.241 / 58.792	0.384 / -177.466
2.800GHz	0.685 / 138.511	1.610 / 34.615	0.258 / 56.910	0.403 / -179.062
3.000GHz	0.694 / 134.278	1.508 / 31.418	0.275 / 55.043	0.422 / 179.863

at $V_{CE} = 8\text{ V}$, $I_c = 60\text{ mA}$

freq	S(1,1)	S(2,1)	S(1,2)	S(2,2)
400.0MHz	0.609 / -177.577	10.236 / 89.634	0.043 / 67.524	0.298 / -136.960
600.0MHz	0.624 / 176.054	6.880 / 82.340	0.060 / 70.319	0.284 / -147.915
800.0MHz	0.625 / 170.897	5.207 / 76.186	0.078 / 70.991	0.287 / -153.940
1.000GHz	0.641 / 166.188	4.218 / 70.384	0.096 / 70.792	0.291 / -157.780
1.200GHz	0.642 / 165.265	3.542 / 66.212	0.115 / 70.340	0.288 / -163.688
1.400GHz	0.644 / 161.855	3.034 / 62.018	0.133 / 69.286	0.298 / -165.983
1.600GHz	0.652 / 158.556	2.694 / 57.404	0.151 / 67.991	0.309 / -168.469
1.800GHz	0.660 / 155.190	2.413 / 53.342	0.170 / 66.342	0.322 / -170.583
2.000GHz	0.663 / 152.092	2.182 / 49.105	0.188 / 64.683	0.336 / -172.504
2.200GHz	0.664 / 148.505	1.995 / 45.084	0.207 / 62.886	0.351 / -174.405
2.400GHz	0.677 / 144.765	1.835 / 41.457	0.224 / 61.084	0.368 / -175.606
2.600GHz	0.691 / 141.787	1.696 / 37.762	0.241 / 59.148	0.382 / -177.182
2.800GHz	0.691 / 138.066	1.593 / 34.094	0.259 / 57.179	0.401 / -178.710
3.000GHz	0.695 / 133.679	1.499 / 30.997	0.276 / 55.245	0.420 / -179.850

at $V_{CE} = 8\text{ V}$, $I_c = 70\text{ mA}$

freq	S(1,1)	S(2,1)	S(1,2)	S(2,2)
400.0MHz	0.613 / -179.201	10.087 / 89.259	0.042 / 69.079	0.288 / -136.751
600.0MHz	0.631 / 174.771	6.773 / 81.904	0.060 / 71.257	0.275 / -147.398
800.0MHz	0.631 / 169.440	5.128 / 75.857	0.078 / 72.140	0.278 / -153.200
1.000GHz	0.645 / 165.629	4.149 / 69.972	0.096 / 71.712	0.283 / -156.868
1.200GHz	0.656 / 165.321	3.491 / 65.850	0.114 / 71.069	0.281 / -162.678
1.400GHz	0.651 / 161.862	2.996 / 61.524	0.133 / 69.940	0.291 / -164.907
1.600GHz	0.661 / 158.607	2.650 / 56.942	0.151 / 68.518	0.303 / -167.266
1.800GHz	0.669 / 154.655	2.376 / 52.802	0.170 / 66.973	0.317 / -169.368
2.000GHz	0.664 / 151.676	2.156 / 48.512	0.188 / 65.248	0.331 / -171.282
2.200GHz	0.670 / 148.424	1.962 / 44.507	0.207 / 63.399	0.347 / -173.140
2.400GHz	0.685 / 144.377	1.810 / 40.896	0.224 / 61.633	0.364 / -174.400
2.600GHz	0.692 / 141.046	1.676 / 37.101	0.242 / 59.608	0.379 / -176.000
2.800GHz	0.699 / 138.017	1.565 / 33.446	0.259 / 57.640	0.399 / -177.610
3.000GHz	0.702 / 133.651	1.474 / 30.425	0.277 / 55.702	0.419 / -178.804