



PRODUCT SPECIFICATION

Model No:CST-S30320B7/S30321B7

Descriptions:

- 0.3 Inch Triad Digit SMD Display
- Emitting Color : Super Bright Blue



CUSTOMER APPROVED	APPROVED BY	CHECKED BY	PREPARED BY
SIGNATURES			

CHINA SEMICONDUCTOR CORPORATION
Address:2FL. NO.909,Chung-Cheng Road,
Chung-Ho City Taipei Hsien,Taiwan.

Tel:886-2-2223-9696
Fax:886-2-2223-9377

OPTO PLUS TECHNOLOGIES CO.,LTD
Address:696 Shun jiang Rd.,Ji Shan St.Shaoxing,
ZheJiang,China

Tel:86-0575-88623888
Fax:86-0575-88623112



Model No : CST-S30320/S30321B7

Features -

1. 0.3 inch (7.62mm) digit height.
2. Qualified according to JEDEC moisture sensitivity Level 2a.
3. RoHS compliant.
4. Low power consumption.
5. Easy mounting on P.C. board.

Device Selection Guide -

Model No.	Chip		Description
	Material	Emitting Color	
CST-S30320B7	InGaN	Super Bright Blue	Common Anode
CST-S30321B7	InGaN	Super Bright Blue	Common Cathode

Mechanical Dimensions -

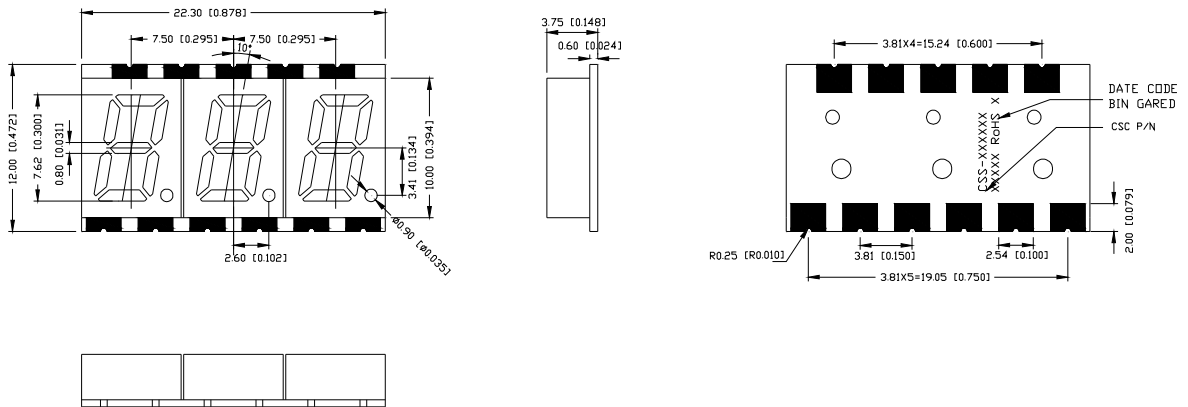

Notes:
All dimensions are in millimeters [inches],
and tolerance is ± 0.25 [0.010]
unless otherwise noted.



Model No : CST-S30320/S30321B7

Internal Circuit Diagrams -

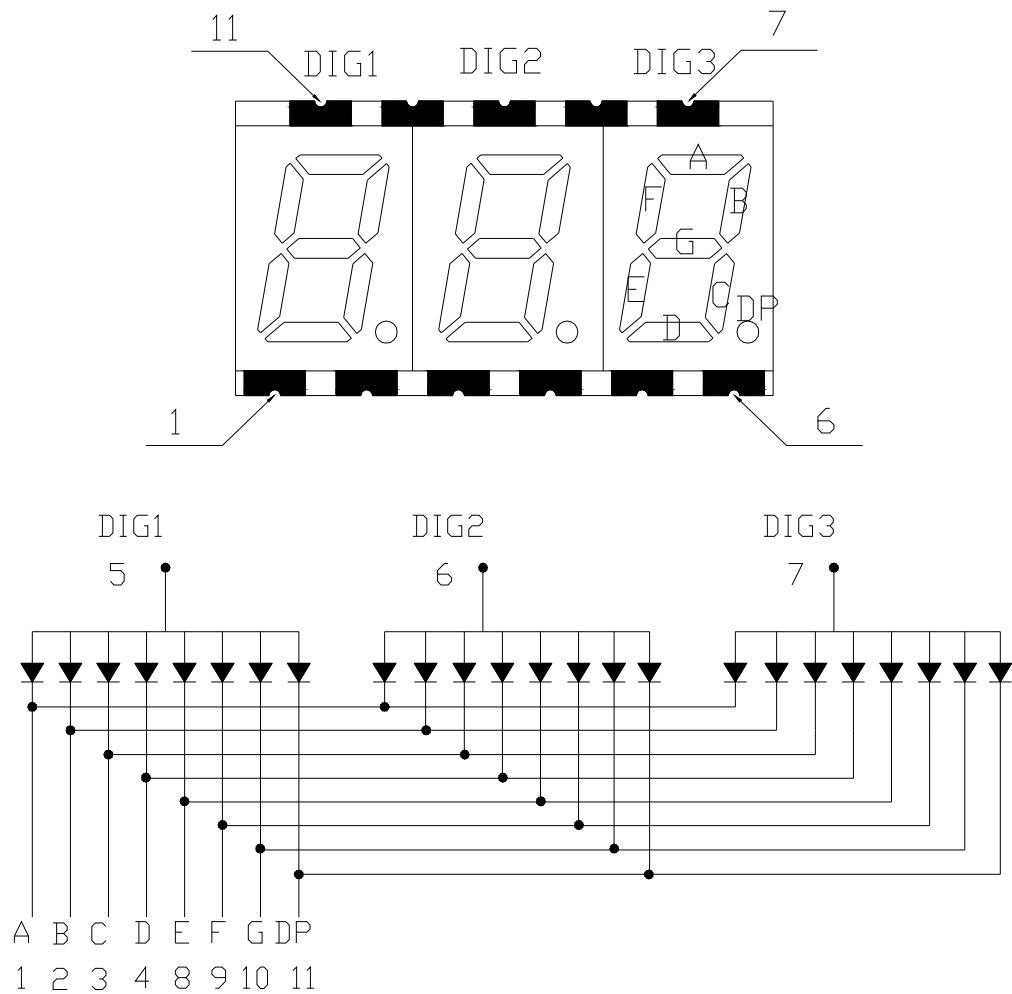

CST-S30320 Common Anode
(CST-S30321 Common Cathode)



Model No : CST-S30320/S30321B7

■ **Absolute Maximum Rating -**

(Ta=25°C)

Parameter	Symbol	Rating	Unit
Power Dissipation Per Dice	P_{AD}	120	mW
Continuous Forward Current Per Dice	I_{AF}	30	mA
Peak Current Per Dice(duty cycle 1/10,1KHz)	I_{PF}	100	mA
Derating Linear From 25°C Per Dice	-	0.4	mA/°C
Reverse Voltage Per Dice	V_R	5	V
Operating Temp.	T_{opr}	-40 ~ +105	°C
Storage Temp.	T_{stg}	-40 ~ +105	°C

■ **Electro-optical Characteristics -**

(Ta=25°C)

Parameter	Symbol	Min.	Typ.	Max.	Unit	Condition
Forward Voltage Per Segment	V_F	-	3.5	4.0	V	I _F =20mA
Luminous Intensity Per Segment	I_v	3.5	9	-	mcd	I _F =10mA
Peak Emission Wavelength	λ_P	-	470	-	nm	I _F =20mA
Spectrum Radiation Bandwidth	Δλ	-	30	-	nm	I _F =20mA
Reverse Current	I_R	-	-	50	μA	V _R =5V
Luminous Intensity Matching Ratio	I_{V-m}	-	-	2:1	-	I _F =10mA



Model No : CST-S30320/S30321B7

Typical Electrical / Optical Characteristics Curves -

(Ta = 25°C Unless Otherwise Noted)

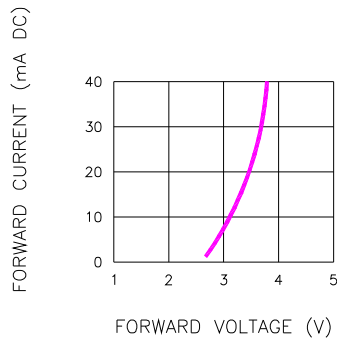

Fig.1 FORWARD CURRENT VS. FORWARD VOLTAGE

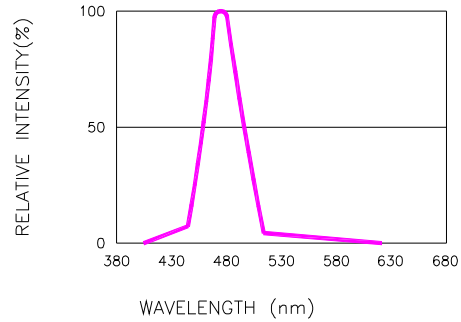

Fig.2 RELATIVE INTENSITY VS. WAVELENGTH

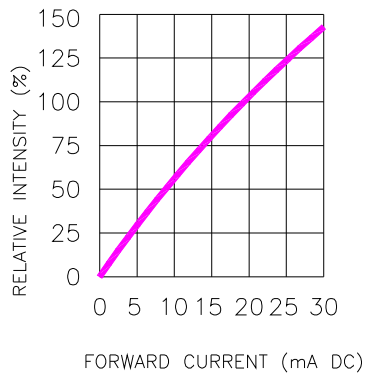

Fig.3 RELATIVE INTENSITY VS. FORWARD CURRENT

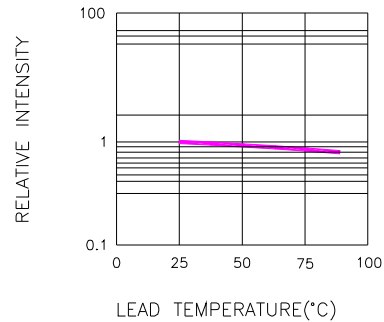

Fig.4 RELATIVE INTENSITY VS. LEAD TEMPERATURE
(PULSED 20 mA; 300us PULSE, 10ms PERIOD)

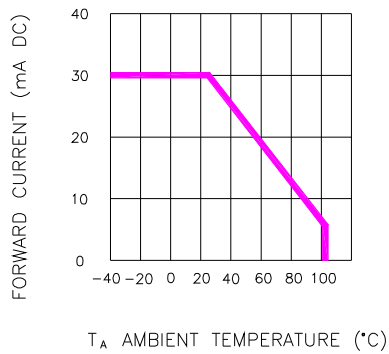

Fig.5 FORWARD CURRENT VS. AMBIENT TEMPERATURE

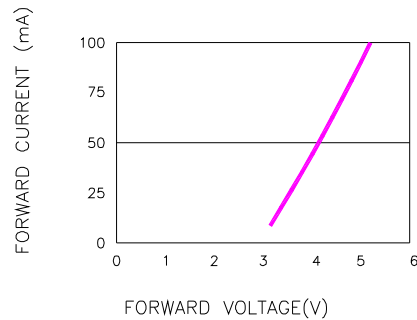

Fig.6 PEAK FORWARD VOLTAGE VS. FORWARD (100us TEST PULSE, 1% DUTY CYCLE)



Model No : CST-S30320/S30321B7

SMT REFLOW SOLDERING INSTRUCTIONS

IR Reflow Temperature / Time :

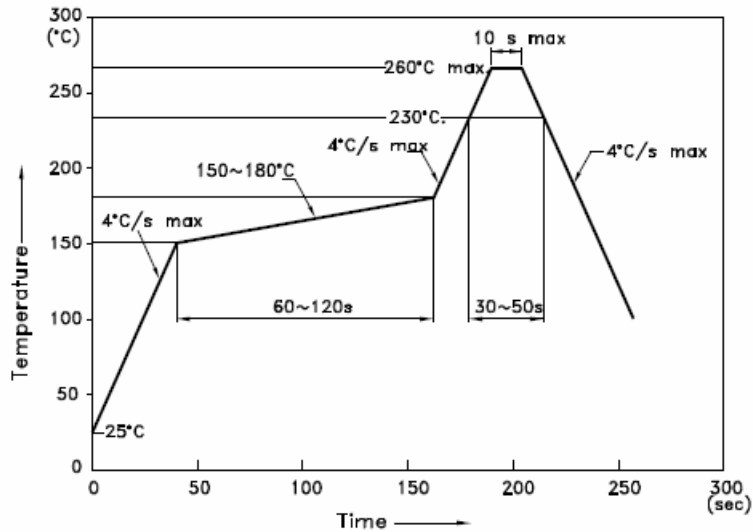

NOTES:

1. We recommend the reflow temperature 245°C(+/-5°C). The maximum soldering temperature should be limited to 260°C.
2. Don't cause stress to the epoxy resin while it is exposed to high temperature.
3. Number of reflow process shall be 2 times or less.

Soldering Pad Size

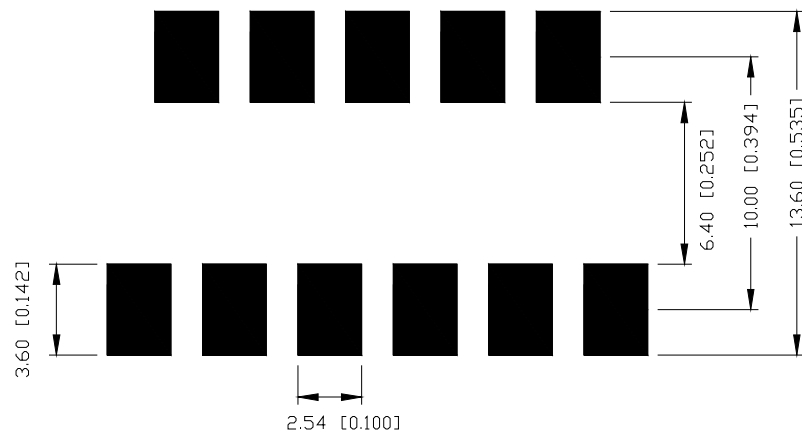



Model No : CST-S30320/S30321B7

REEL DIMENSIONS

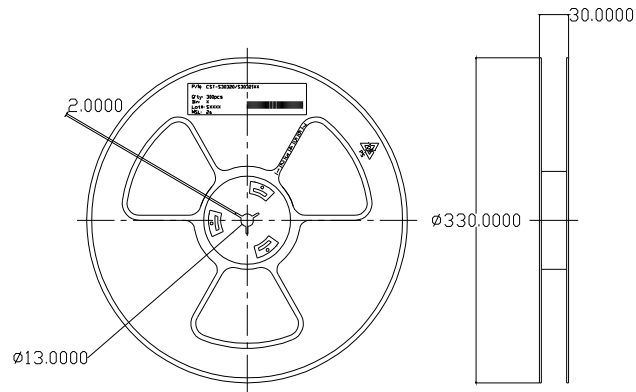

PACKING & LABEL SPECIFICATIONS

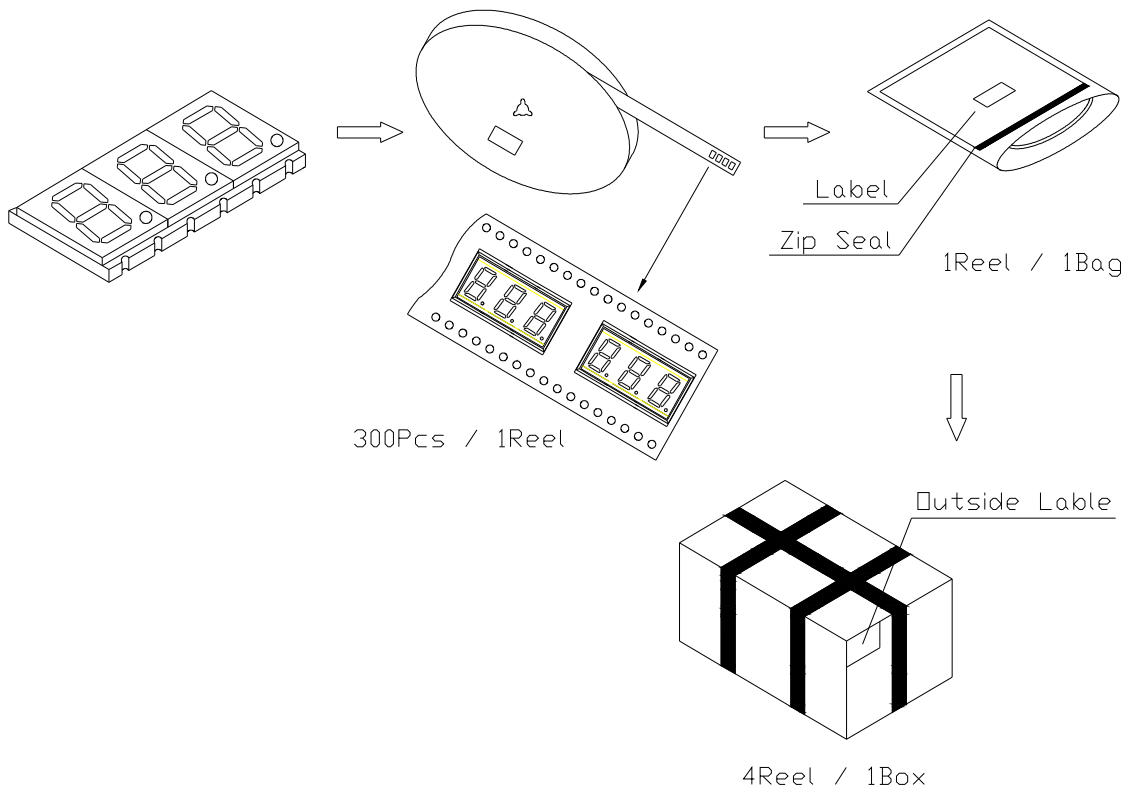

4Reel / 1Box

Size: 440X340X270 mm

Note: The specifications are subject to change without notice. Please contact us for updated