

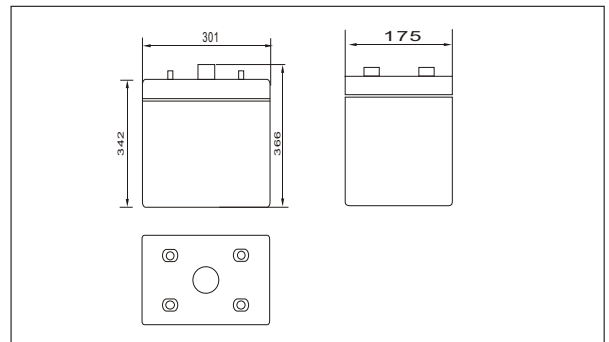

SW26000E(2V600AH)



Outer dimensions (mm)



Specifications

Nominal Voltage		2 V
Rated capacity (10 hour rate)		600 Ah
Dimensions	Total Height	366 mm (14.4 inches)
	Height	342 mm (13.5 inches)
	Length	301 mm (11.9 inches)
	Width	175 mm (6.89 inches)
Weight Approx		39.5 Kg (86.9 lbs)

Terminal Type (mm)

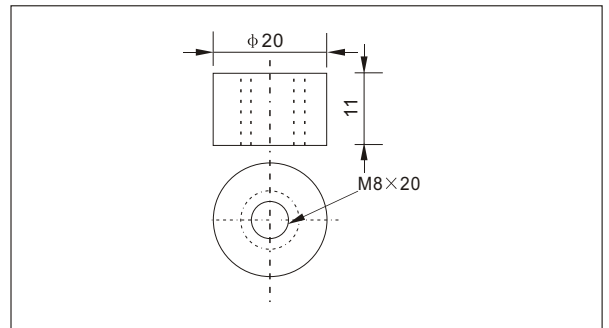

Characteristics

Capacity 25°C(77°F)	10 hour rate(60 A)	600 AH
	5 hour rate(96 A)	480 AH
	1 hour rate(330 A)	330 AH
	1.5 hour discharge to 1.75 V	240 A
Internal Resistance	Full charged Battery at 25°C(77°F)	0.9 mΩ
Capacity affected by Temperature (10hour rate)	40°C(104°F)	102%
	25°C(77°F)	100%
	0°C(32°F)	85%
	-15°C(5°F)	65%
Self-Discharge at 25°C(77°F)	Capacity after 3 month storage	91%
	Capacity after 6 month storage	82%
	Capacity after 12 month storage	64%
Terminal	T20	
Charge (constant Voltage)	Cycle	Initial Charging Current less than 150 A Voltage 2.35-2.40V
	Float	Voltage 2.25-2.30V

Discharge Curves 25°C(77°F)

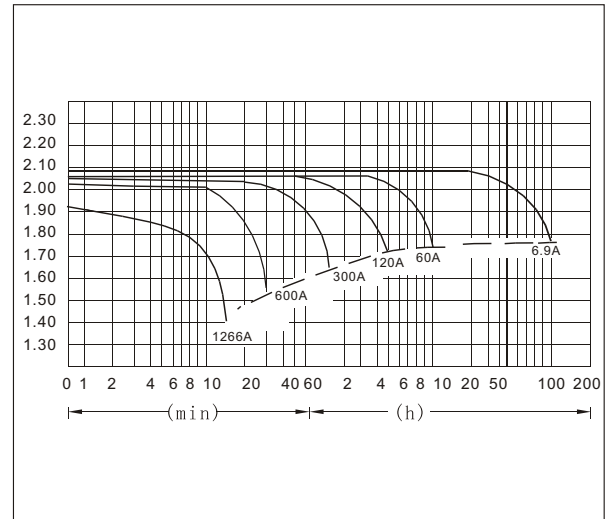

Constant Current(Amp) and Constant Power(Watt) Discharge Table at 25°C(77°F)

Time		10min	30min	1h	3h	4h	5h	8h	10h	20h	50h	100h
1.60V	A	1266	684	360	154.2	120.0	99.0	69.8	63.0	34.02	14.2	7.3
	W	2343	1221	695	298	232	191	135	122	65.7	28.1	14.4
1.70V	A	1230	666	338.4	150.0	117.0	97.2	68.3	61.4	33.18	13.7	7.1
	W	2254	1210	653	290	226	188	132	119	64.0	27.1	14.0
1.75V	A	1175	634	328	146.4	115.2	96.0	67.8	60.0	32.76	13.4	6.9
	W	2184	1142	632	283	222	185	131	117	63.2	26.7	13.7
1.80V	A	1098	613	317	142.8	113.4	93.6	66.0	58.5	32.40	13.2	6.8
	W	2099	1099	605	277	218	182	128	116	62.9	26.2	13.6
1.85V	A	1008	564	298	138.0	110.0	91.2	64.2	57.00	30.78	13.0	6.6
	W	2063	1090	589	274	217	181	127	113	61.0	25.7	13.1