

ULTRA LOW PHASE NOISE AMPLIFIER, 6 - 12 GHz



Typical Applications

The HMC-C072 is ideal for:

- Microwave Radio
- Military & Space
- Test Instrumentation
- VSAT

Functional Diagram

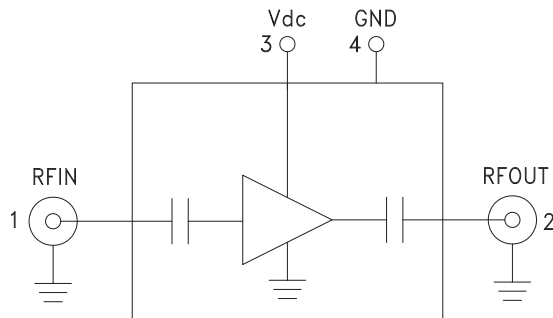

Features

- Ultra Low Phase Noise: -167 dBc/Hz @ 1 kHz
- Noise Figure: 4.5 dB
- Gain: 11 dB
- Psat: 22 dBm
- 50 Ohm Matched Input/Output
- Single Supply Voltage: +7V @ 170mA
- Hermetically Sealed Module
- Field Replaceable SMA Connectors
- 55°C to +85°C Operating Temperature

General Description

The HMC-C072 is a GaAs HBT Ultra Low Noise Amplifier in a miniature, hermetic module designed to operate between 6 and 12 GHz. This high dynamic range amplifier module provides 11 dB of gain, 4.5 dB noise figure and up to 23 dB of output power with a single supply of +7V. The ultra low phase noise contribution of -167 dBc/Hz at 1 kHz offset, enables superior modulation accuracy within transceiver architectures. The wideband distributed amplifier I/O's are internally matched to 50 Ohms and DC blocked for robust performance. The module features removable SMA connectors which can be detached to allow direct connection of the I/O pins to a microstrip or coplanar circuit.

Electrical Specifications, $T_A = +25^\circ\text{C}$, $V_{dc} = +7V$

Parameter	Min.	Typ.	Max.	Units
Frequency Range	6 - 12			GHz
Gain	9	11		dB
Gain Flatness		± 1		dB
Gain Variation Over Temperature		0.015		dB/ °C
Noise Figure		4.5		dB
Input Return Loss		15		dB
Output Return Loss		15		dB
Output Power for 1 dB Compression (P1dB)	17	20		dBm
Saturated Output Power (Psat)		22		dBm
Output Third Order Intercept (IP3)		34		dBm
Phase Noise @ 100 Hz, Psat, 10 GHz		-157		dBc/Hz
Phase Noise @ 1 kHz, Psat, 10 GHz		-167		dBc/Hz
Phase Noise @ 10 kHz, Psat, 10 GHz		-176		dBc/Hz
Phase Noise @ 100 kHz, Psat, 10 GHz		-180		dBc/Hz
Supply Current		170	200	mA

For price, delivery, and to place orders, please contact Hittite Microwave Corporation:
20 Alpha Road Chelmsford, MA 01824 Phone: 978-250-3343 Fax: 978-250-3373
Order Online at www.hittite.com

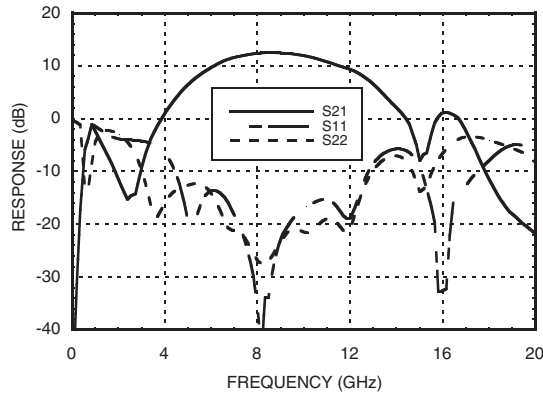
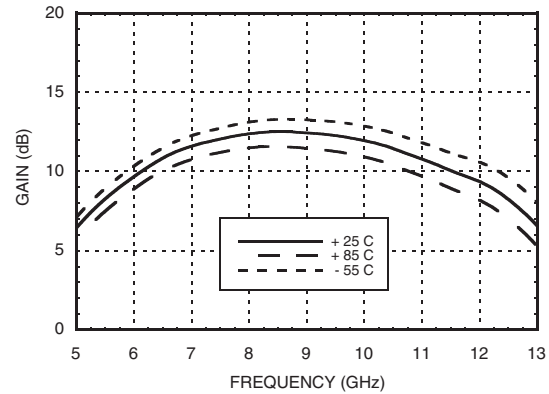
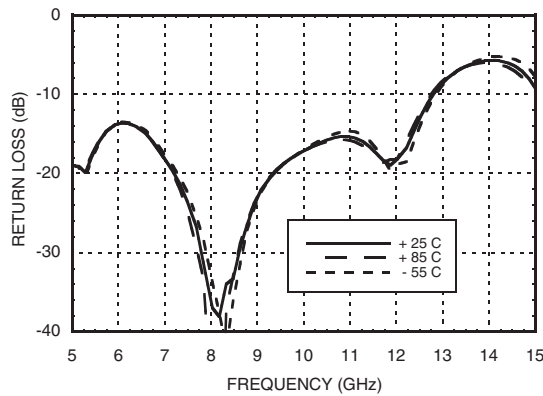
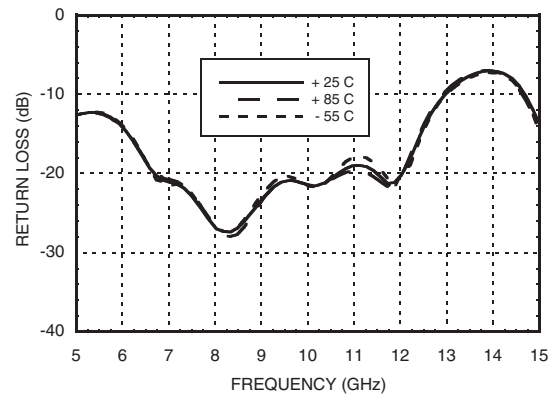
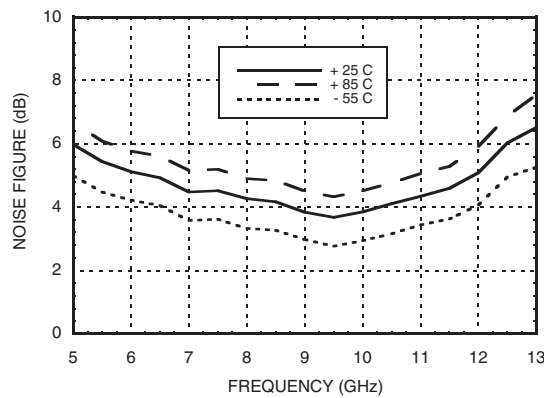
Gain & Return Loss

Gain vs. Temperature

Input Return Loss vs. Temperature

Output Return Loss vs. Temperature

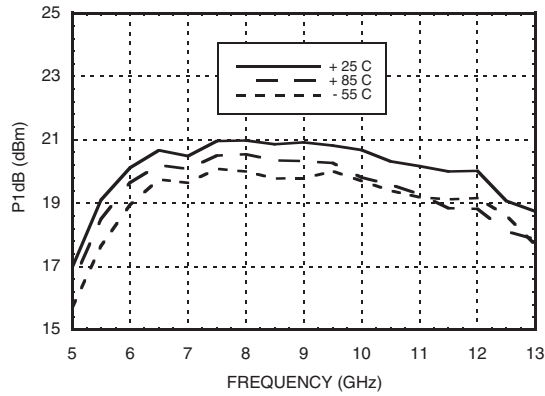
Noise Figure vs. Temperature



ULTRA LOW PHASE NOISE AMPLIFIER, 6 - 12 GHz

Output P1dB vs. Temperature



Output Psat vs. Temperature

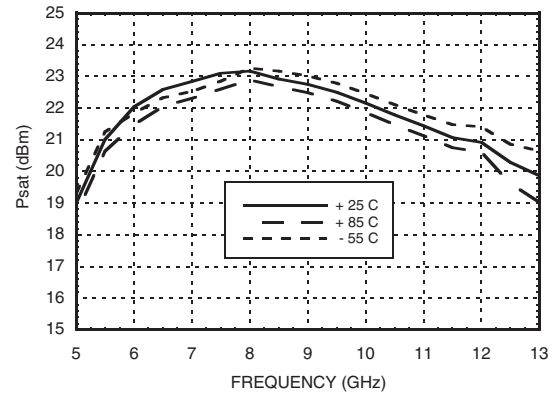

Output IP3 vs. Temperature

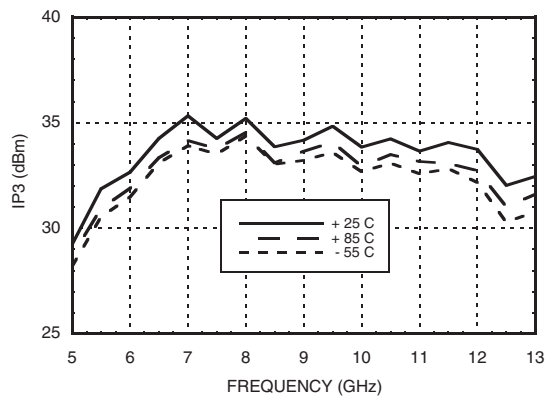

Phase Noise at Pout = 10 dBm @ 10 GHz

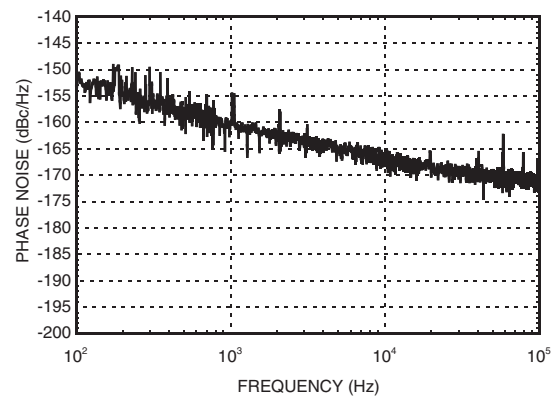

Phase Noise at Pout = P1dB @ 10 GHz

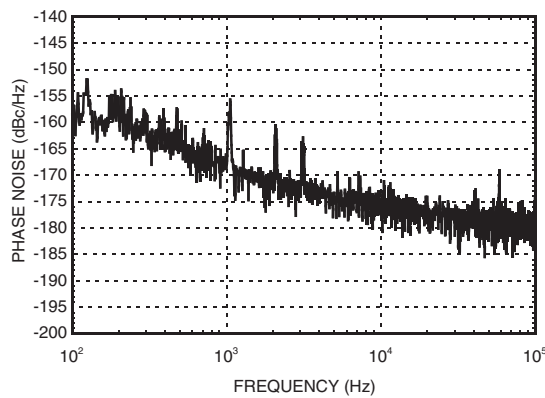

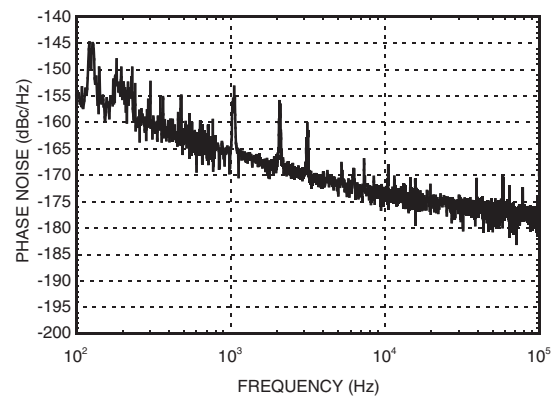

Phase Noise at Pout = Psat @ 10 GHz



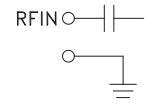
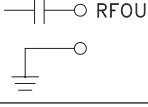
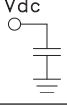

Absolute Maximum Ratings

Bias Supply Voltage (Vdc)	+8V
RF Input Power (RFIN)	+15 dBm
Continuous P _{diss} (T = 85 °C)	1.62W
Channel Temperature	135 °C
Thermal Resistance	20 °C/W
Storage Temperature	-65 to +150 °C
Operating Temperature	-55 to +85 °C

**ELECTROSTATIC SENSITIVE DEVICE
OBSERVE HANDLING PRECAUTIONS**
Pin Descriptions

Pin Number	Function	Description	Interface Schematic
1	RFIN & RF Ground	RF input connector, coaxial female, field replaceable. This pin is AC coupled and matched to 50 Ohms.	
2	RFOUT & RF Ground	RF output connector, coaxial female, field replaceable. This pin is AC coupled and matched to 50 Ohms.	
3	Vdc	Power supply voltage for the amplifier. (+7V to +8V)	
4	GND	Power supply ground.	

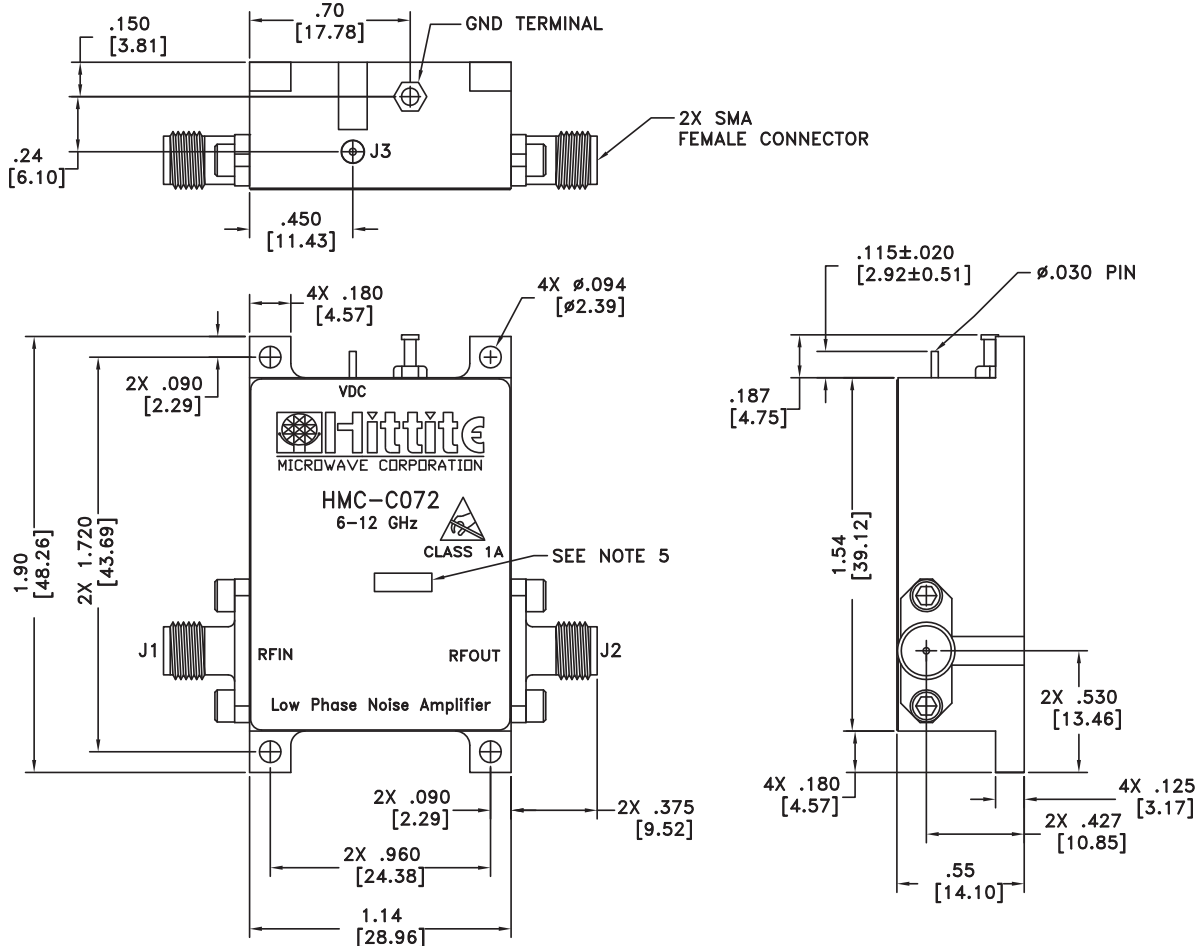
Outline Drawing



Package Information

Package Type	C-16
Package Weight	107 gms [1]

[1] ±1 gms Tolerance

NOTES:

1. PACKAGE, LEADS, COVER MATERIAL: KOVAR™
2. FINISH: GOLD PLATE OVER NICKEL PLATE.
3. ALL DIMENSIONS ARE IN INCHES [MILLIMETERS].
4. TOLERANCES:
 - 4.1 .XX = ±.02
 - 4.2 .XXX = ±.010
5. MARK LOT NUMBER ON 0.080 X 0.250 LABEL WHERE SHOWN, WITH 0.030° MIN TEXT HEIGHT.



**ULTRA LOW PHASE NOISE
AMPLIFIER, 6 - 12 GHz**

Notes: