



CHENMKO ENTERPRISE CO.,LTD

Lead free devices

**SURFACE MOUNT
NPN Switching Transistor**

VOLTAGE 40 Volts CURRENT 0.6 Ampere

CHT4401PT

APPLICATION

- * Telephony and professional communication equipment.
- * Other switching applications.

FEATURE

- * Small flat package. (SOT-23)
- * Low current (Max.=600mA).
- * Suitable for high packing density.
- * Low voltage (Max.=40V) .
- * High saturation current capability.
- * Voltage controlled small signal switch.

CONSTRUCTION

- * NPN Switching Transistor

MARKING

- * S1P

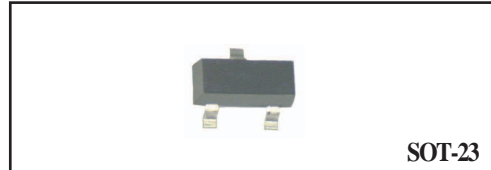

SOT-23

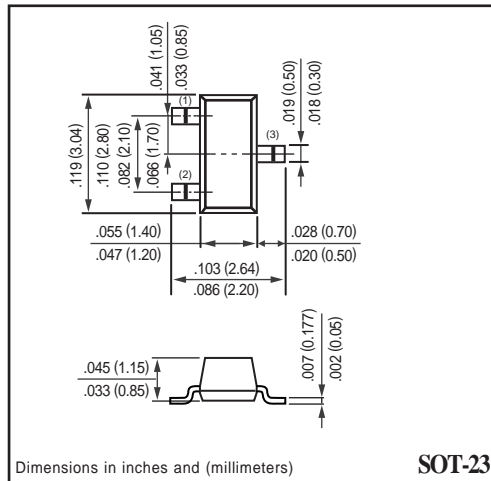

Dimensions in inches and (millimeters)

SOT-23

CIRCUIT

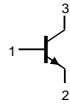

LIMITING VALUES

In accordance with the Absolute Maximum Rating System (IEC 60134).

SYMBOL	PARAMETER	CONDITIONS	MIN.	MAX.	UNIT
V _{CBO}	collector-base voltage	open emitter	—	60	V
V _{CEO}	collector-emitter voltage	open base	—	40	V
V _{EBO}	emitter-base voltage	open collector	—	6	V
I _C	collector current DC		—	600	mA
P _{tot}	total power dissipation	T _{amb} ≤ 25 °C; note 1	—	350	mW
T _{stg}	storage temperature		−55	+150	°C
T _j	junction temperature		—	150	°C
T _{amb}	operating ambient temperature		−55	+150	°C

Note

2004-11

1. Transistor mounted on an FR4 printed-circuit board.

RATING CHARACTERISTIC CURVES (CHT4401PT)

THERMAL CHARACTERISTICS

SYMBOL	PARAMETER	CONDITIONS	VALUE	UNIT
$R_{th\ j-a}$	thermal resistance from junction to ambient	note 1	200	°C/W

Note

1. Transistor mounted on an FR4 printed-circuit board.

CHARACTERISTICS

$T_{amb} = 25\text{ °C}$ unless otherwise specified.

SYMBOL	PARAMETER	CONDITIONS	MIN.	MAX.	UNIT
I_{CBO}	collector cut-off current	$I_E = 0; V_{CB} = 60\text{ V}$	–	50	nA
I_{EBO}	emitter cut-off current	$I_C = 0; V_{EB} = 6\text{ V}$	–	50	nA
h_{FE}	DC current gain	$V_{CE} = 1\text{ V}$; note 1 $I_C = 0.1\text{ mA}$ $I_C = 1\text{ mA}$ $I_C = 10\text{ mA}$ $I_C = 150\text{ mA}$ $V_{CE} = 2\text{ V}$; note 2 $I_C = 500\text{ mA}$	20 40 80 100 40	– – – 300 –	
V_{CEsat}	collector-emitter saturation voltage	$I_C = 150\text{ mA}; I_B = 15\text{ mA}$	–	400	mV
		$I_C = 500\text{ mA}; I_B = 50\text{ mA}$	–	750	mV
V_{BEsat}	base-emitter saturation voltage	$I_C = 150\text{ mA}; I_B = 15\text{ mA}$	750	950	mV
		$I_C = 500\text{ mA}; I_B = 50\text{ mA}$	–	1200	mV
C_c	collector capacitance	$I_E = I_E = 0; V_{CB} = 5\text{ V}; f = 140\text{ KHz}$	–	6.5	pF
C_e	emitter capacitance	$I_C = I_C = 0; V_{BE} = 500\text{ mV}; f = 140\text{ KHz}$	–	30	pF
f_T	transition frequency	$I_C = 20\text{ mA}; V_{CE} = 10\text{ V}; f = 100\text{ MHz}$	250	–	MHz

Switching times (between 10% and 90% levels);

t_{on}	turn-on time	$I_{Con} = 150\text{ mA}; I_{Bon} = 15\text{ mA}; I_{Boff} = -15\text{ mA}$	–	35	ns
t_d	delay time		–	15	ns
t_r	rise time		–	20	ns
t_{off}	turn-off time		–	250	ns
t_s	storage time		–	200	ns
t_f	fall time		–	60	ns

Note

1. Pulse test: $t_p \leq 300\text{ }\mu\text{s}$; $\delta \leq 0.02$.

RATING CHARACTERISTIC CURVES (CHT4401PT)

Typical Characteristics

Typical Pulsed Current Gain vs Collector Current

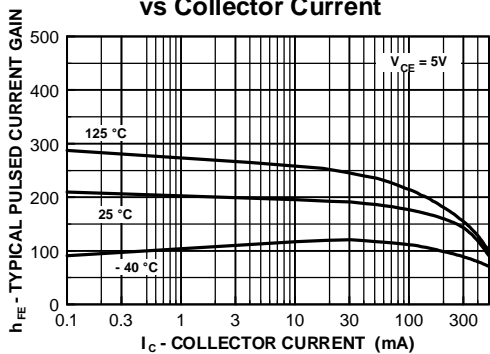

Collector-Emitter Saturation Voltage vs Collector Current

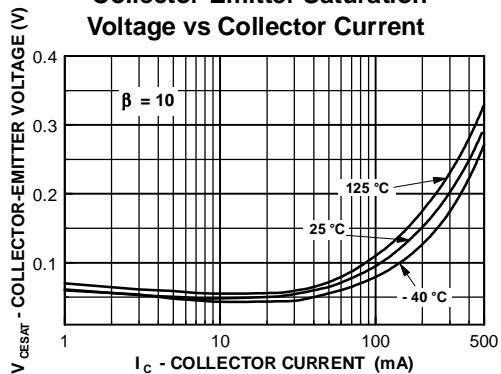

Base-Emitter Saturation Voltage vs Collector Current

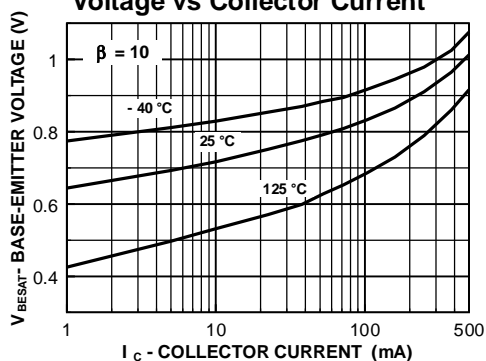

Base-Emitter ON Voltage vs Collector Current

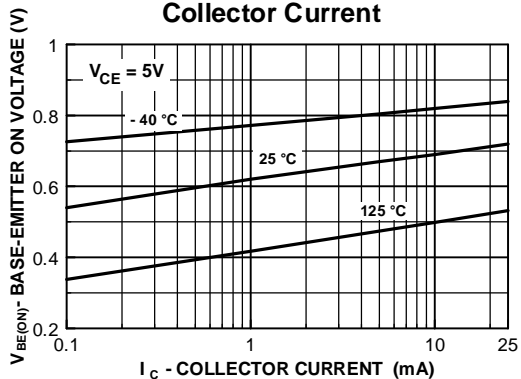

Collector-Cutoff Current vs Ambient Temperature

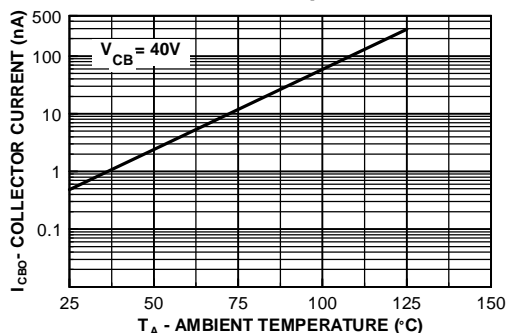

Emitter Transition and Output Capacitance vs Reverse Bias Voltage

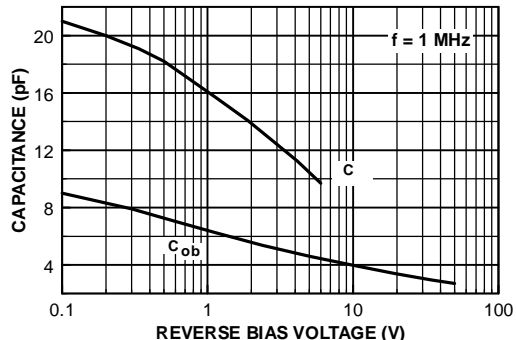

RATING CHARACTERISTIC CURVES (CHT4401PT)

**Turn On and Turn Off Times
vs Collector Current**

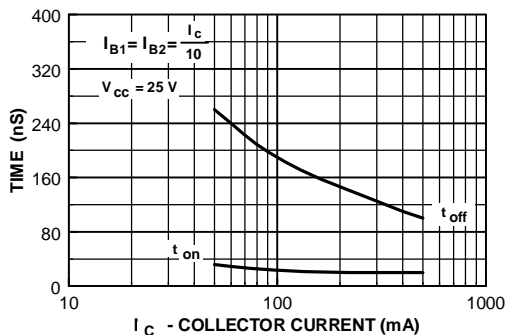

**Switching Times
vs Collector Current**

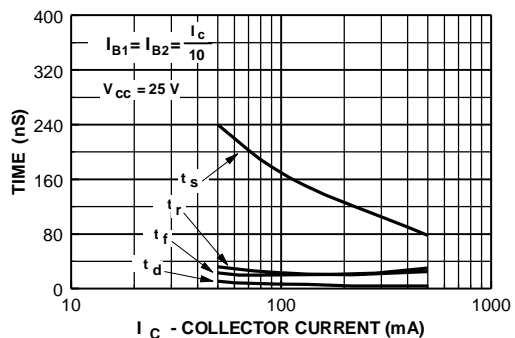

**Power Dissipation vs
Ambient Temperature**

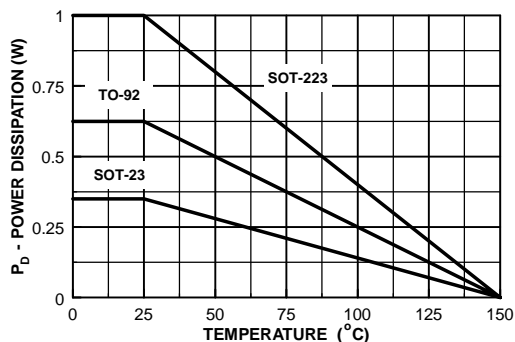

RATING CHARACTERISTIC CURVES (CHT4401PT)

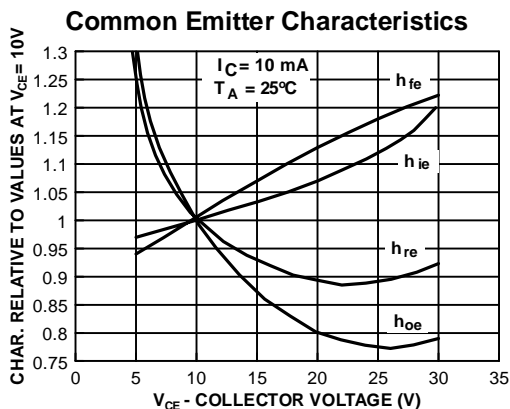
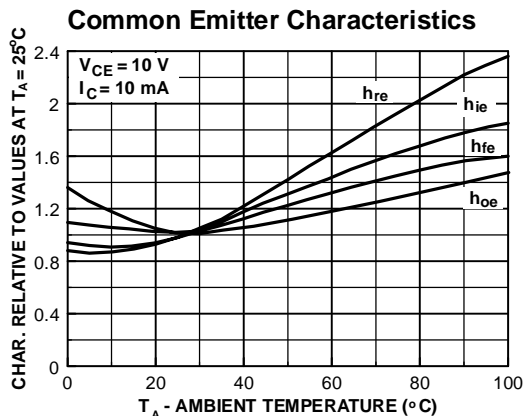
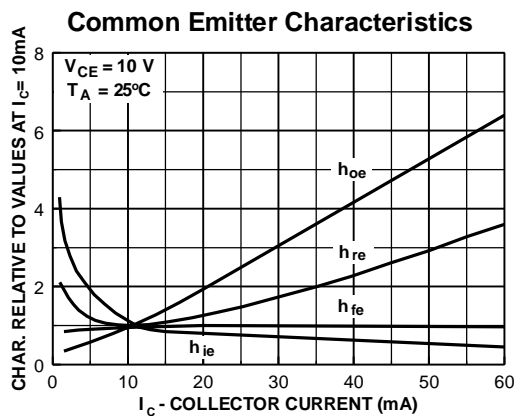

RATING CHARACTERISTIC CURVES (CHT4401PT)

Test Circuits

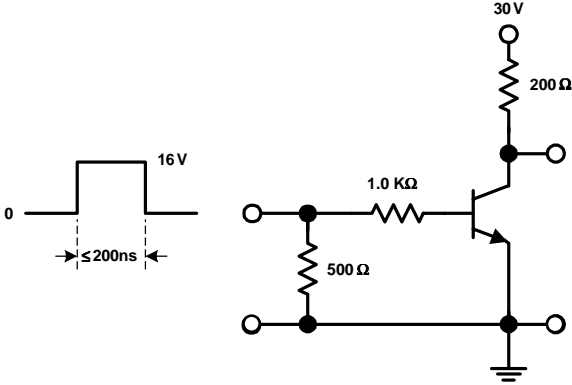

FIGURE 1: Saturated Turn-On Switching Timer

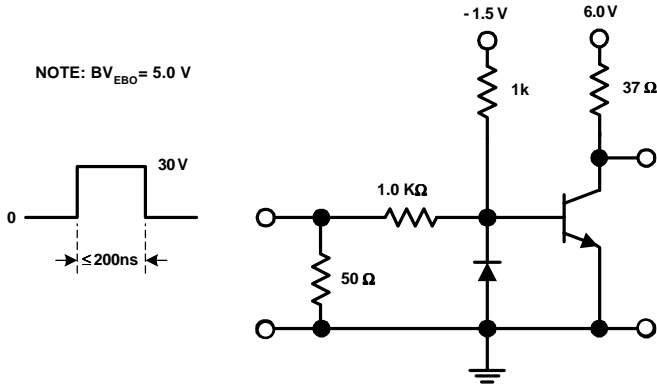

FIGURE 2: Saturated Turn-Off Switching Time