

### Features

- S<sub>21</sub> = 50.6 dB @ 698 MHz  
= 49.4 dB @ 787 MHz
- NF of 1.0 dB over Frequency
- Unconditionally Stable
- Single 5V Supply
- High OIP3 @ Low Current

### Description

The plerow™ APM-Series is an internally matched amplifier mini-module for such application band in SMD package with the output P1dB of 29 dBm. It is compactly designed for low current consumption and high OIP3. Integrating all the components for biasing and matching within the module enhances production yield and throughput as well. It passes through the stringent DC, RF, and reliability tests. Not sample test but 100% quality control test is made before packing.

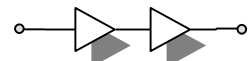

2-stage Single Type

### Specifications (in Production)

Typ. @ T = 25°C, V<sub>s</sub> = 5 V, Freq. = 742.5 MHz, Z<sub>o,sys</sub> = 50 ohm

Parameter	Unit	Specifications		
		Min	Typ	Max
Frequency Range	MHz	698		787
Gain	dB	49	50	
Gain Flatness	dB		± 0.6	± 0.7
Noise Figure	dB		1.0	1.1
Output IP3 <sup>(1)</sup>	dBm	44	47	
S <sub>11</sub> / S <sub>22</sub> <sup>(2)</sup>	dB			-14 / -14
Output P1dB	dBm	28	29	
Switching Time <sup>(3)</sup>	µsec		-	
Supply Current	mA		460	500
Supply Voltage	V		5	
Impedance	Ω		50	
Max. RF Input Power	dBm	C.W 23 ~ 25 (before fail)		
Package Type & Size	mm	Surface Mount Type, 13Wx13Lx3.8H		

### More Information

Website: [www.asb.co.kr](http://www.asb.co.kr)  
E-mail: [sales@asb.co.kr](mailto:sales@asb.co.kr)

Tel: (82) 42-528-7223  
Fax: (82) 42-528-7222

ASB Inc., 4th Fl. Venture Town Bldg., 367-17 Goijeong-Dong, Seo-Gu, Daejeon 302-716, Korea

Operating temperature is -40°C to +85°C.

1) OIP3 is measured with two tones at an output power of 12 dBm / tone separated by 1 MHz.

2) S<sub>11</sub>/S<sub>22</sub> (max) is the worst value within the frequency band.

3) Switching time means the time that takes for output power to get stabilized to its final level after switching DC voltage from 0 V to V<sub>s</sub>.

### Outline Drawing (Unit: mm)

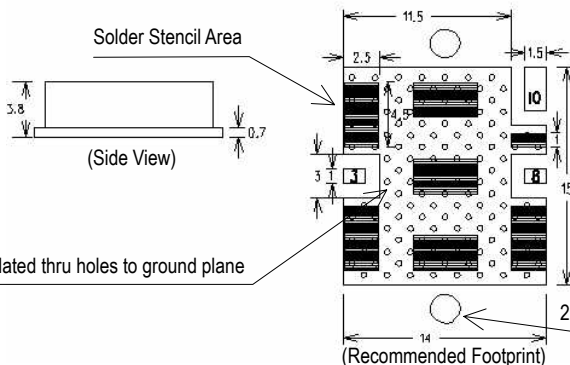
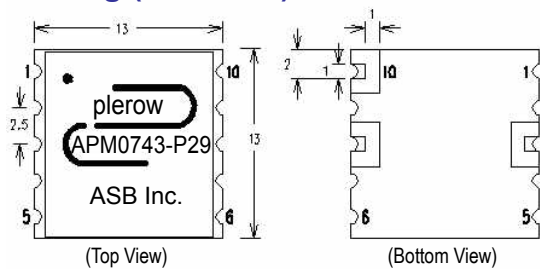

Pin Number	Function
3	RF In
8	RF Out
10	Vs
Others	Ground

Note: 1. The number and size of ground via holes in a circuit board is critical for thermal RF grounding considerations.

2. We recommend that the ground via holes be placed on the bottom of all ground pins for better RF and thermal performance, as shown in the drawing at the left side.

**Typical Performance  
(Measured)**

---

**698~787**

---

**+5 V**

---

**S-parameters**

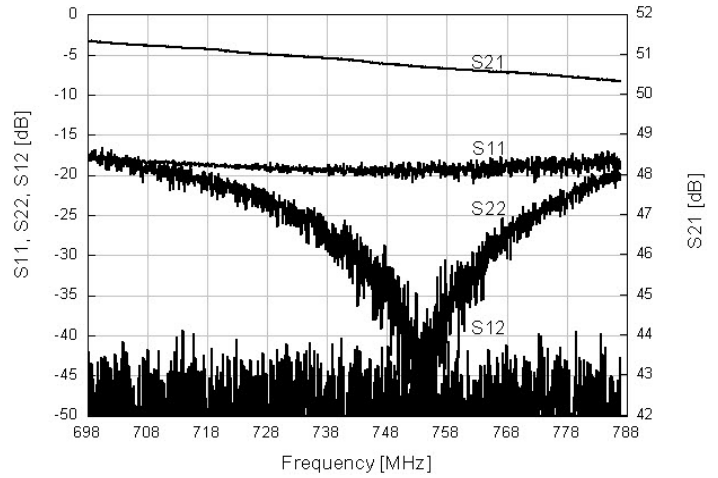

**S-parameters & K Factor**

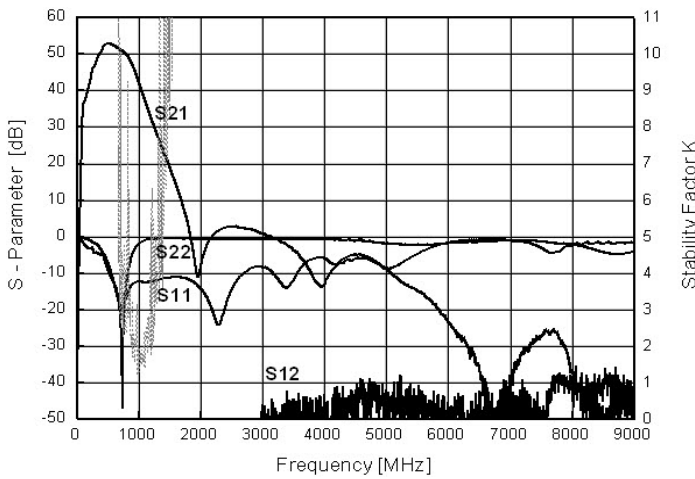

**Noise Figure**

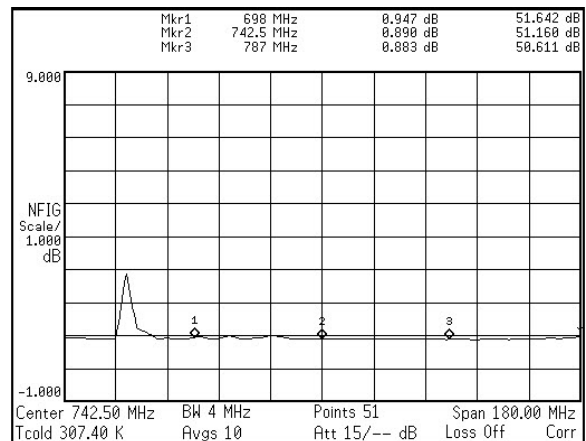

**OIP3**

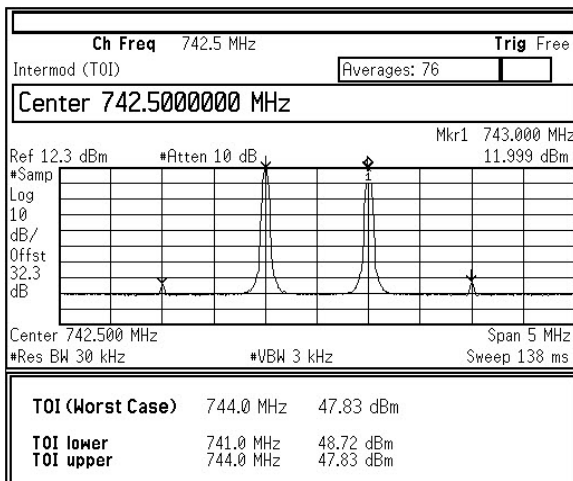

**P1dB**

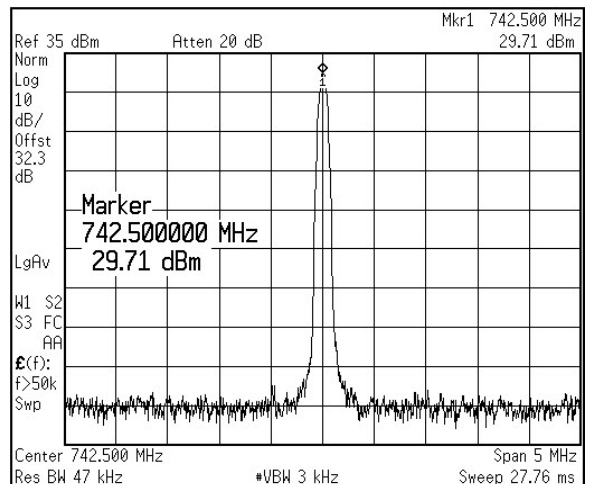

**Output Channel Power**  
(@ ACLR=-45dBc, +/-5MHz Offset)

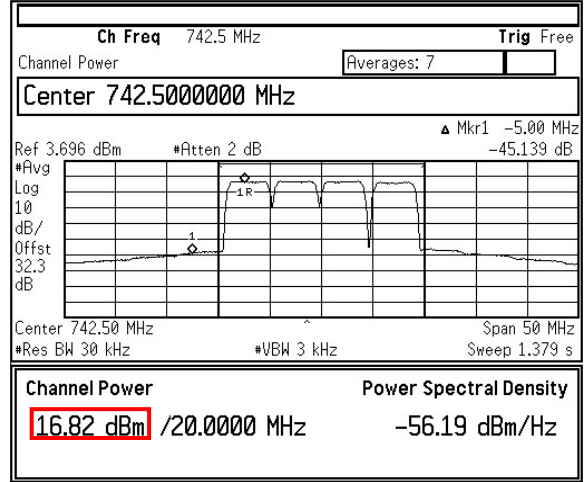
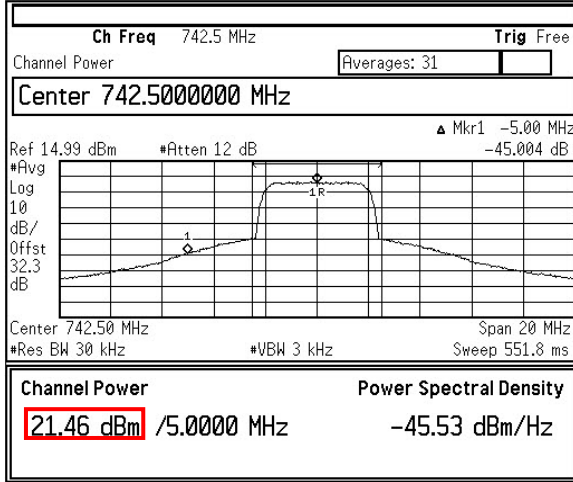

**OIP3 vs Output Power**  
(@ 1MHz offset, 1-tone power)

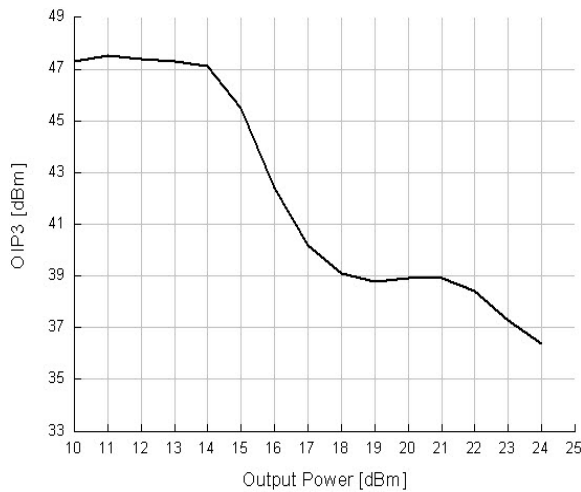

**ACLR vs Channel Power**

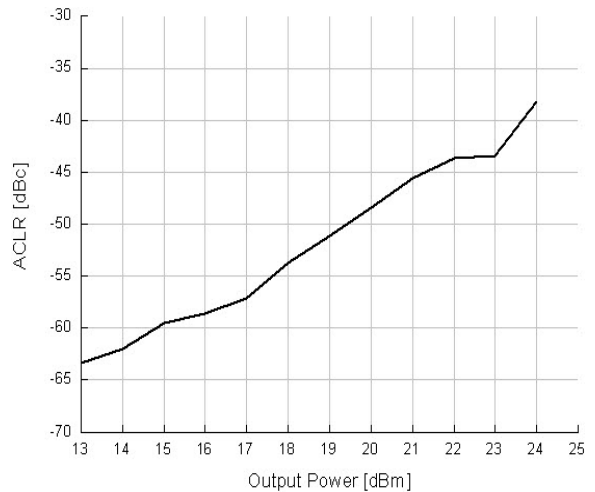

\*\* Test Source : Agilent E4433B (3GPP W-CDMA Test Model-1 64DPCH)

**Application Circuit**

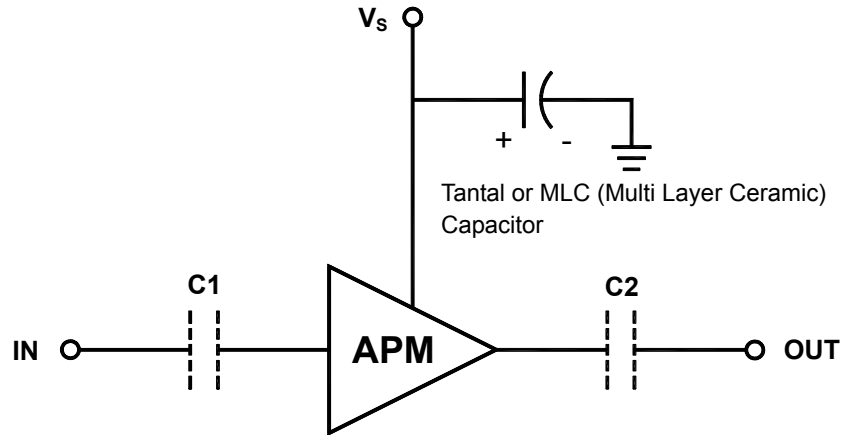

- 1) The tantal or MLC (Multi Layer Ceramic) capacitor is optional and for bypassing the AC noise introduced from the DC supply. The capacitance value may be determined by customer's DC supply status. The capacitor should be placed as close as possible to  $V_s$  pin and be connected directly to the ground plane for the best electrical performance.
- 2) DC blocking capacitors are always necessarily placed at the input and output port for allowing only the RF signal to pass and blocking the DC component in the signal. The DC blocking capacitors are included inside the APM module. Therefore, C1 & C2 capacitors may not be necessary, but can be added just in case that the customer wants. The value of C1 & C2 is determined by considering the application frequency.

**Recommended Soldering Reflow Process**

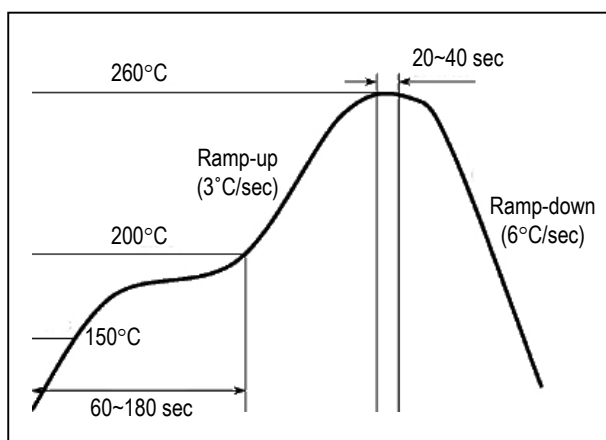

**Evaluation Board Layout**

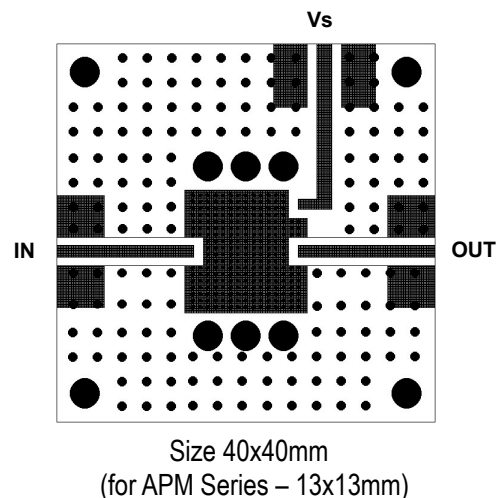

**Channel Power vs. ACLR Test Configuration**

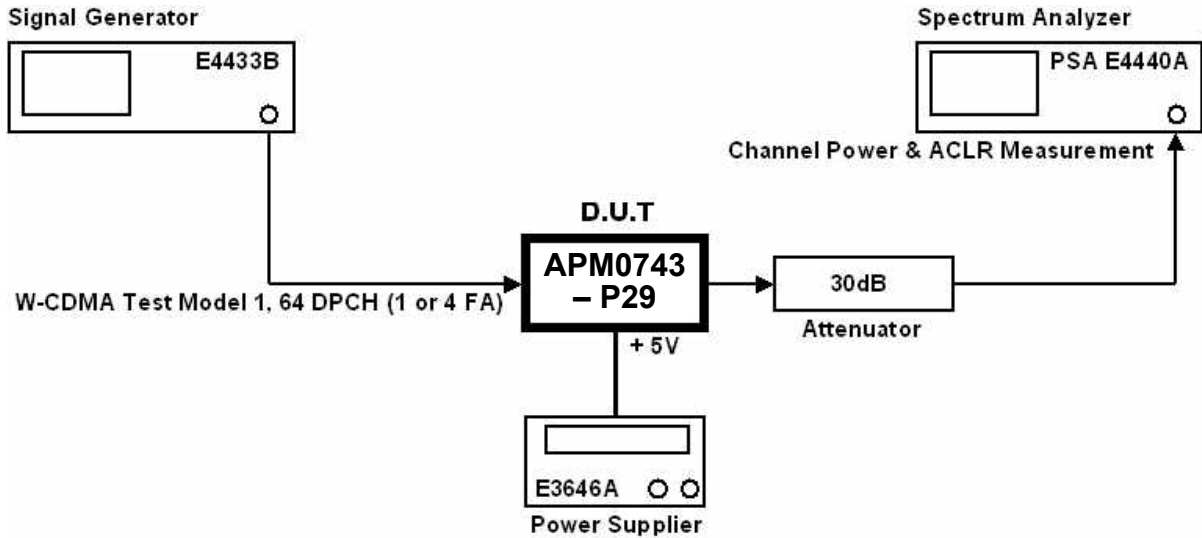

**Evaluation Board attached with Heat Sink**

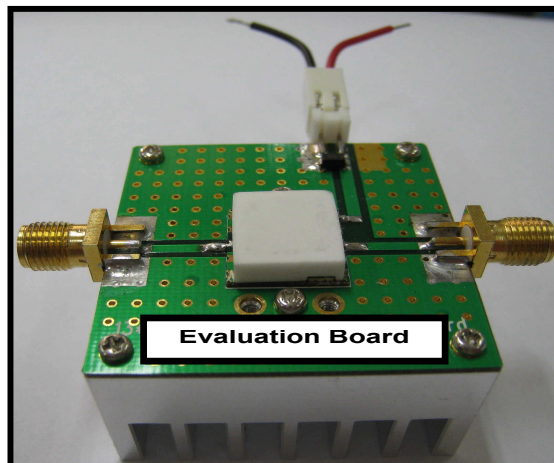

*\* In order to prevent damage of D.U.T (APM-Series) from heating, you must to use a properly sized heat sink for testing a module.*