



# SAW TECHNOLOGY CO., LTD.

No. 3, Industrial 2nd Rd., Ping-Chen Industrial District,  
Taoyuan, 324, Taiwan, R.O.C.

TEL: 886-3-4690038 FAX: 886-3-4697532

E-mail: [tstsales@mail.taisaw.com](mailto:tstsales@mail.taisaw.com) Web: [www.taisaw.com](http://www.taisaw.com)

## Approval Sheet For Product Specification

Issued Date:

Product Name: SAW Filter 70MHz SMD 13.3×6.5mm

TST Parts No.: TB0740A

Customer Parts No.: \_\_\_\_\_

Company: _____
Division: _____
Approved by : _____
Date: _____

Checked by: \_\_\_\_\_ Ricky Lee *Ricky*

Approval by: \_\_\_\_\_ Francis Chen *[Signature]*

Date: \_\_\_\_\_ 2009/02/12



# TAI-SAW TECHNOLOGY CO., LTD.

No. 3, Industrial 2nd Rd., Ping-Chen Industrial District,  
Taoyuan, 324, Taiwan, R.O.C.

TEL: 886-3-4690038 FAX: 886-3-4697532

E-mail: [tstsales@mail.taisaw.com](mailto:tstsales@mail.taisaw.com) Web: [www.taisaw.com](http://www.taisaw.com)

## IF SAW Filter 70MHz(BW=9MHz) SMD 13.3X6.5mm

MODEL NO.: TB0740A

REV.1.0

### A. MAXIMUM RATING:

1. Operating Temperature: -20 °C ~ +80 °C
2. Storage Temperature: -40 °C ~ +85 °C
3. Input power: 10dBm

RoHS Compliant  
Lead free  
Lead-free soldering

### B. Characteristics :

Ambient Temperature: 25 °C

Characteristics		Value			Mote
		Min.	Typ.	Max.	
Center frequency $F_c$	MHz	69.8	70.0	70.2	
Minimum Insertion loss I.L.	dB	-	10.6	12.0	
1dB BW	MHz	9.0	9.7	-	
3dB BW	MHz	9.5	10	-	
35dB BW	MHz	-	11.7	13.0	
Passband Ripple ( $F_c \pm 4MH$ )	dB	-	0.6	1.0	
Group-Delay Ripple ( $F_c \pm 4MH$ )	nsec	-	80	160	
<b>Attenuation</b> (Reference to Minimum Insertion loss)					
10 ~ 63MHz	dB	40	45	-	
78 ~ 140MHz	dB	40	45	-	
Temp Coefficient	ppm/K	-	-94	-	-
<b>Matching:</b>					
1.The input of the filter will be matched to <u>50 ohm</u>					
2.The output of the filter will be matched to <u>50 ohm</u>					

### C. Frequency Characteristics :

#### 1. S21 Response: (span : 50MHz)

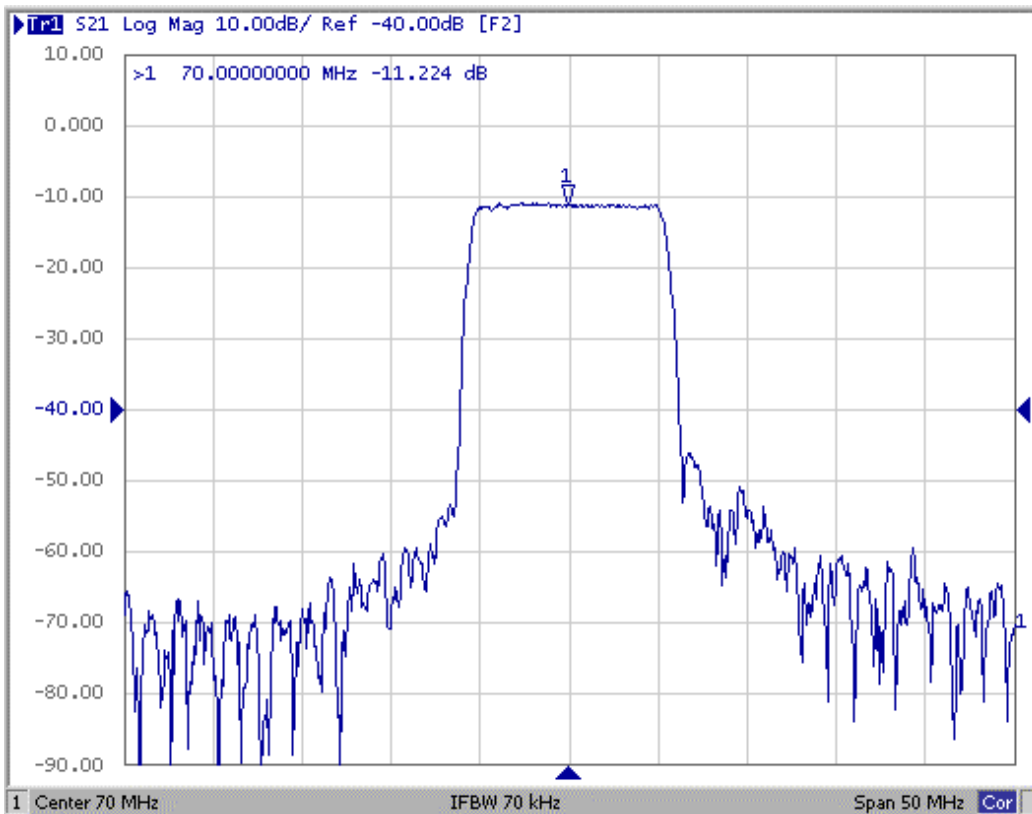

Fig1. Horizontal: 5MHz/Div Vertical: 10dB/Div

#### 2. Group-Delay Ripple: (span : 20MHz)

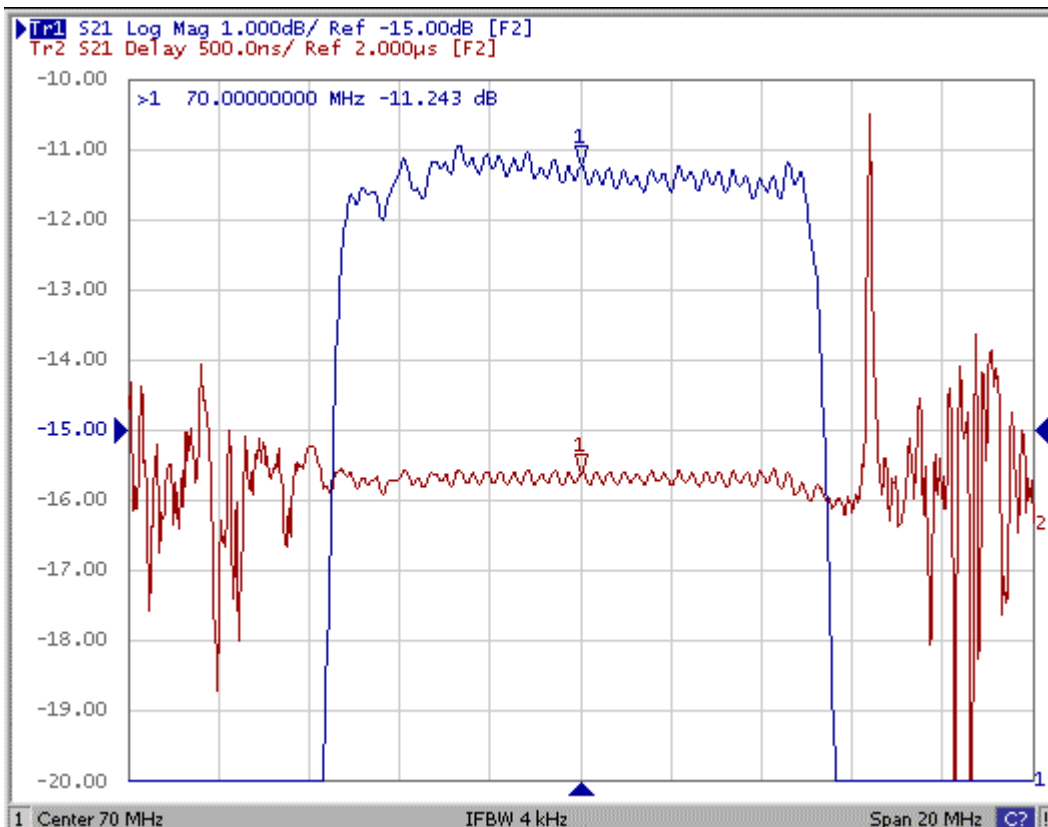
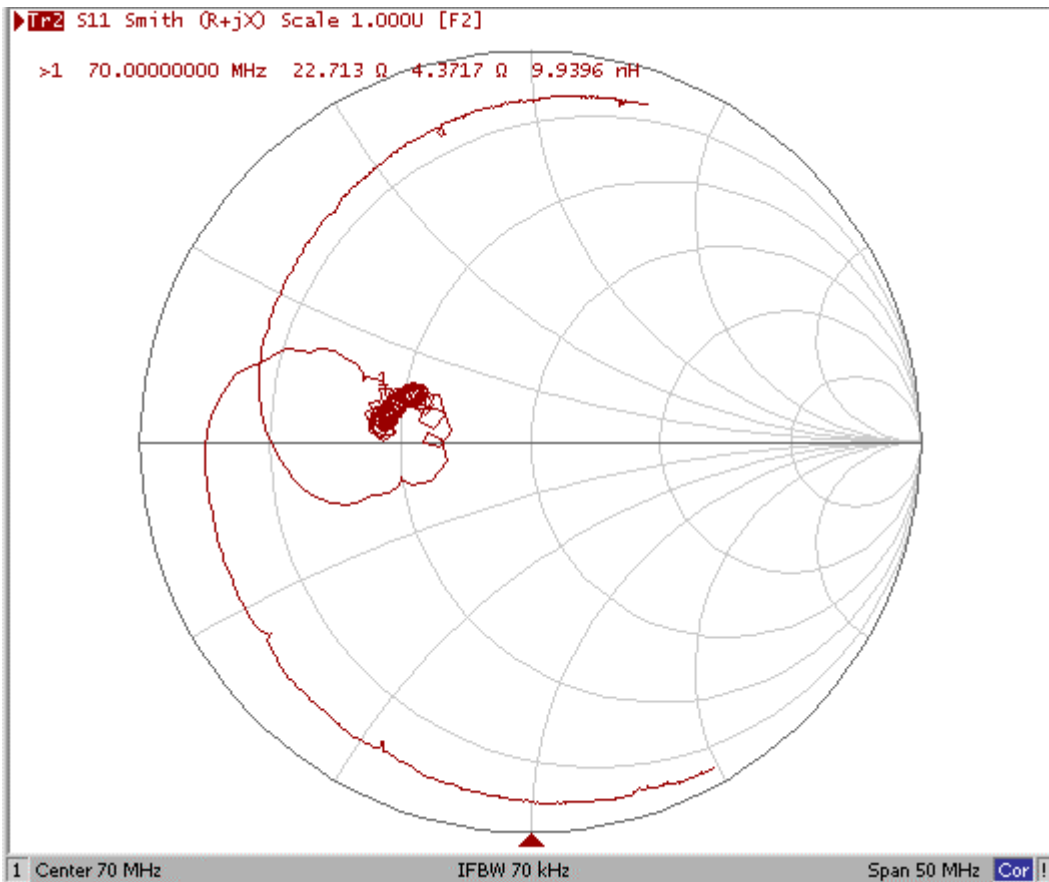
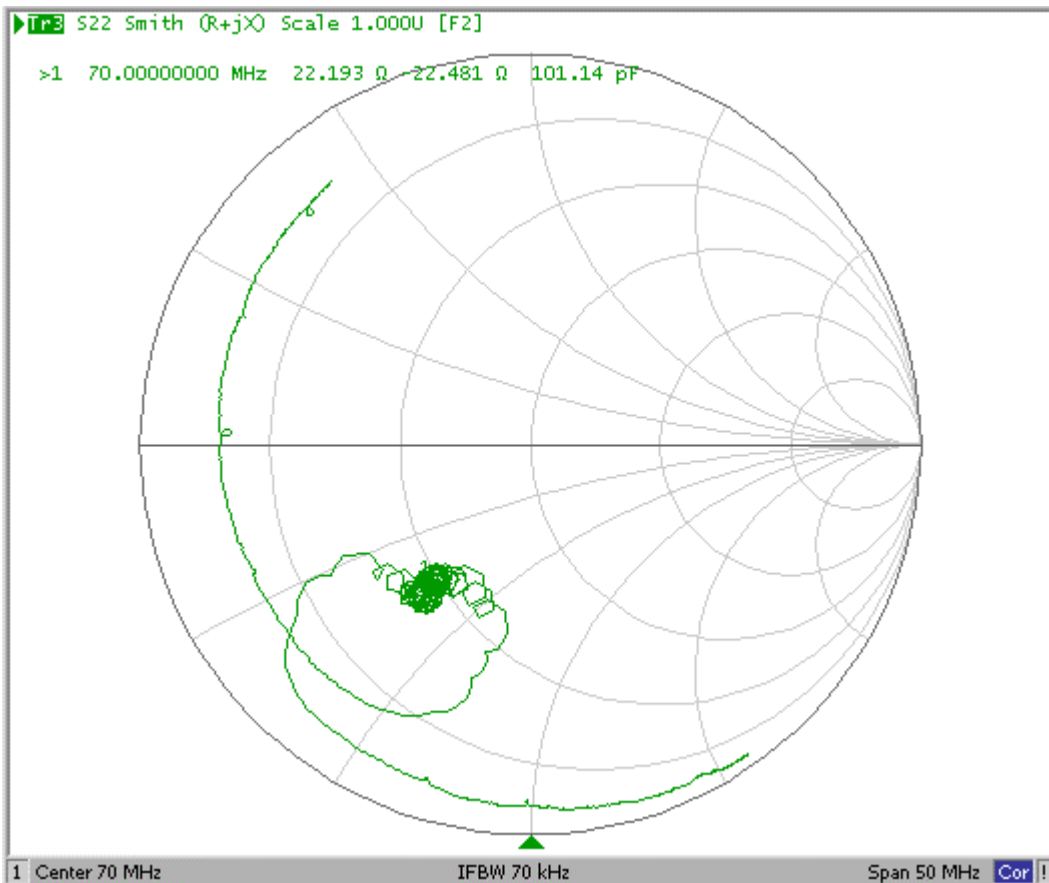

Fig2. Horizontal: 2MHz/Div Vertical: 500nec/Div

### 3. S11 Smith Chart: (span : 50MHz)



### 4. S22 Smith Chart (span : 50MHz)



**D. Measurement Circuit:**

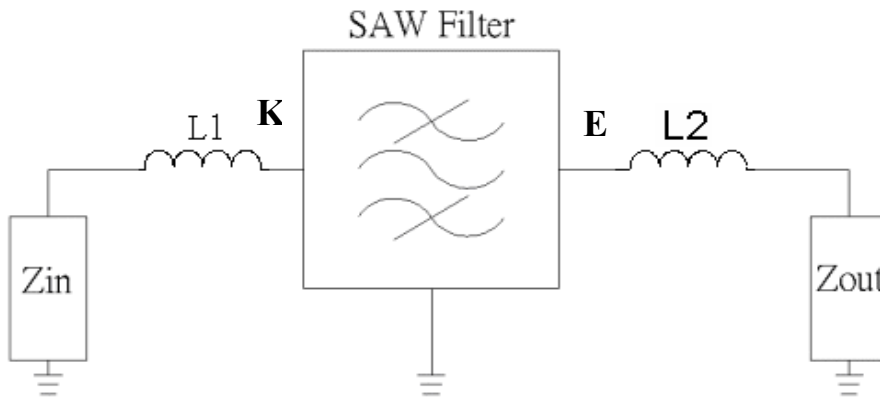

Zin and Zout are  $50\ \Omega$ .  
 $L1 = 220\text{nH}$ ,  $L2 = 150\text{nH}$

**E. Outline Drawing:**

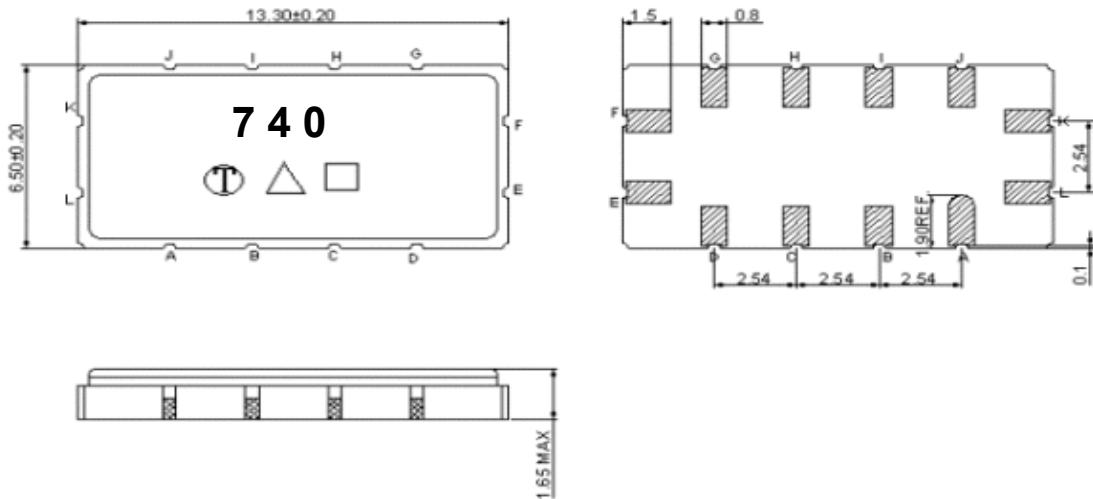

Pin K: RF input

Pin E: RF output

Pin A, B, C, D, G, H, I, L, F, J: To be Ground

□ : Week Code (Follow the table from planner each year)

Unit : mm (week01, 02, 03...52 =>A, B, C...z)

△ : Product / Year Code

Year	2005 2009	2006 2010	2007 2011	2008 2012
Product Code	B	b	<u>B</u>	<u>b</u>

**F. PCB Footprint:**

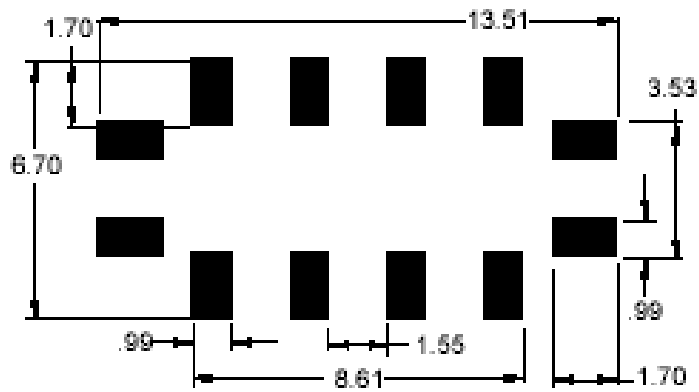

Unit: mm

**H. PACKING:**

**1. REEL DIMENSION**

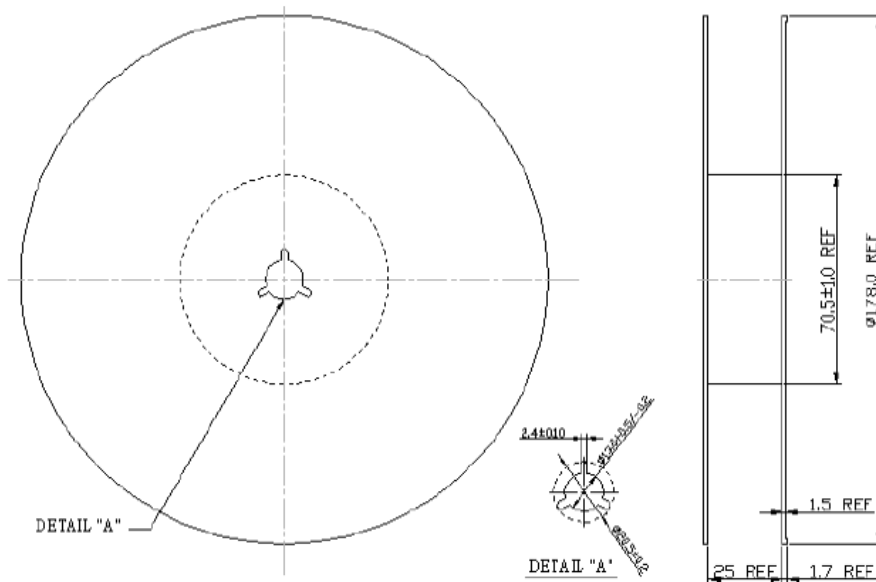

Unit: mm

## 2. TAPE DIMENSION

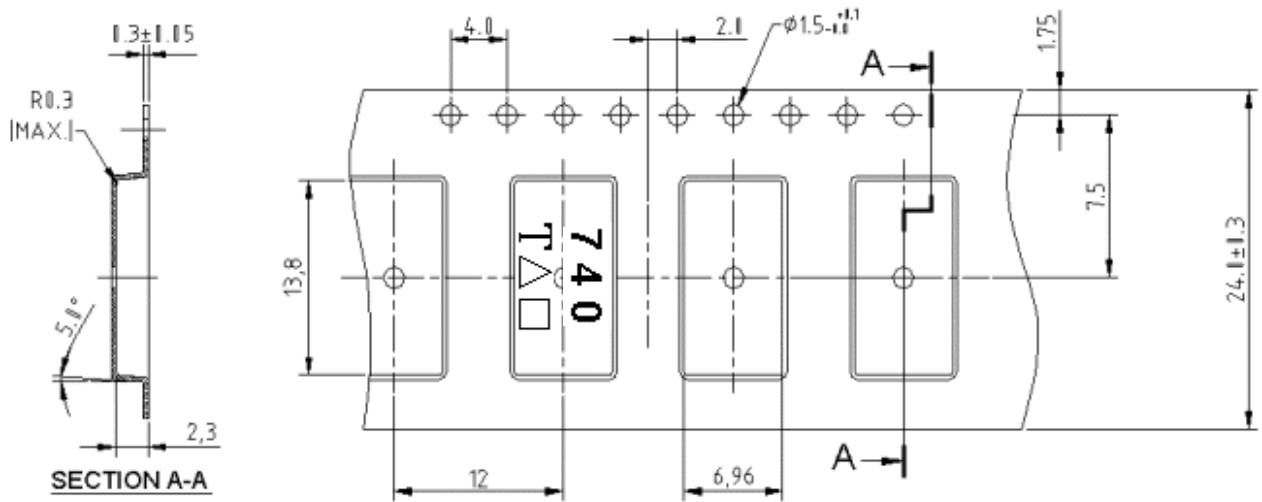

Unit: mm

## I. RECOMMENDED REFLOW PROFILE :

