

Customer Name	Standard	FUJITSU MEDIA DEVICES LIMITED	
System	Cellular SAW Duplexer	DATE	Mar.10, 2006
FMD P/N	FAR-D5GA-881M50-D1AA	Version 4.1mia	

Table 1 Electrical Specification

		Condition	Specification (Ver.4.1 mia)			Unit	Remarks
			Min	Typ.	Max		
Tx to ANT	Insertion loss	824-849MHz	-	1.7	2.2	dB	-
	Pass band ripple		-	0.4	1.0	dB	-
	VSWR (Tx port)		-	1.6	2.0	-	-
	VSWR (Ant port)		-	1.7	2.0	-	-
	Input Power		1.2W > 50k Hours , Ta=+50°C , CW			Watt	-
	Attenuation	779-804MHz	35	42	-	dB	-
		869-894MHz	45	49	-	dB	-
		1570-1580MHz	40	45	-	dB	-
		1648-1698MHz	38	41	-	dB	-
		2472-2547MHz	25	31	-	dB	-
ANT to Rx	Insertion loss	869-894MHz	-	2.4	3.0	dB	-
	Pass band ripple		-	0.7	1.5	dB	-
	VSWR (Rx port)		-	1.6	2.0	-	-
	VSWR (Ant port)		-	1.6	2.0	-	-
	Attenuation	824-849MHz	53	57	-	dB	-
Tx to Rx	Isolation	824-849 MHz	55	59	-	dB	-
		869-894 MHz	47	50	-	dB	-
Storage Temperature			-40 to +100			°C	-
Operating Temperature			-30 to +85			°C	-
Package size		3.0(typ.) x 2.5(typ.) x 0.7(max)			mm	-	

Customer Name	Standard	FUJITSU MEDIA DEVICES LIMITED	
System	Cellular SAW Duplexer	DATE	Mar.10, 2006
FMD P/N	FAR-D5GA-881M50-D1AA	Version 4.1mia	

Dimensions

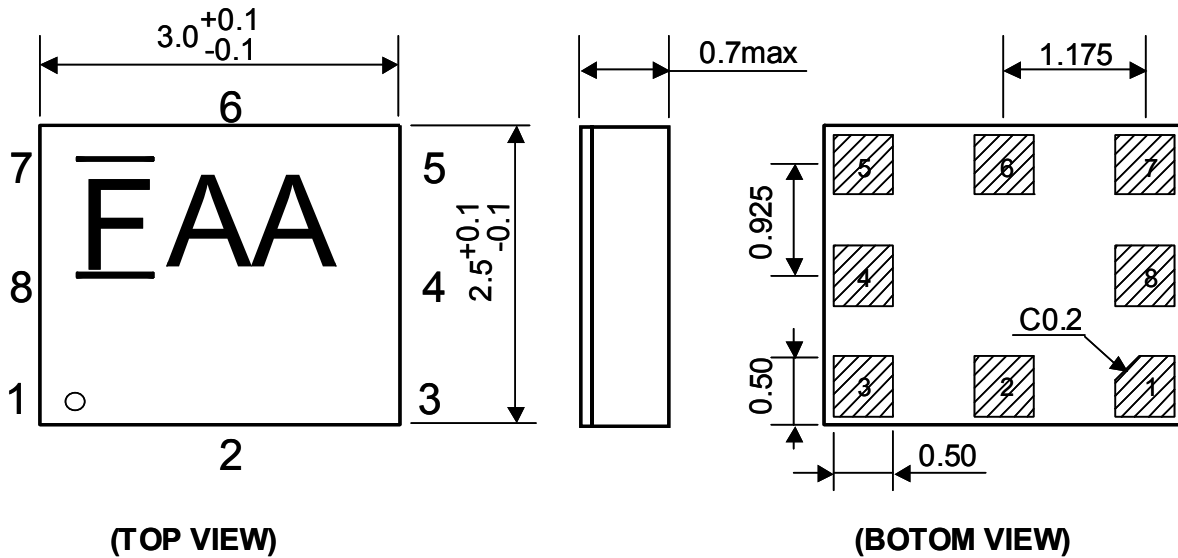

[UNIT : mm]

Pin Configuration

Pin No.	Pin name	Description
1	Tx	Transmitter Pin
2	GND	Ground Pin
3	Rx	Receiver Pin
4	GND	Ground Pin
5	GND	Ground Pin
6	ANT	Antenna Pin
7	GND	Ground Pin
8	GND	Ground Pin

Customer Name	Standard	FUJITSU MEDIA DEVICES LIMITED	
System	Cellular SAW Duplexer	DATE	Mar.10, 2006
FMD P/N	FAR-D5GA-881M50-D1AA	Version 4.1mia	

Evaluation Circuit

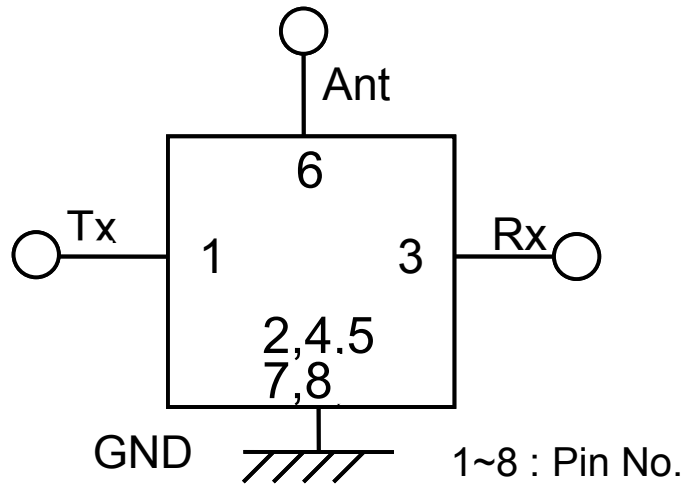

Recommended Foot Print Pattern

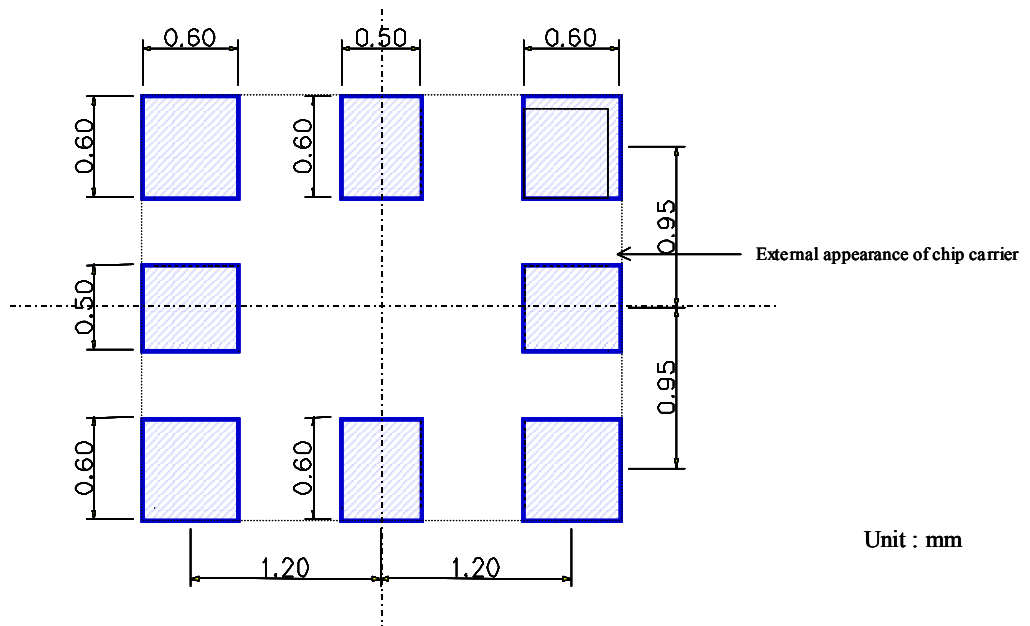

Customer Name	Standard	FUJITSU MEDIA DEVICES LIMITED	
System	Cellular SAW Duplexer	DATE	Mar.10, 2006
FMD P/N	FAR-D5GA-881M50-D1AA	Version 4.1mia	

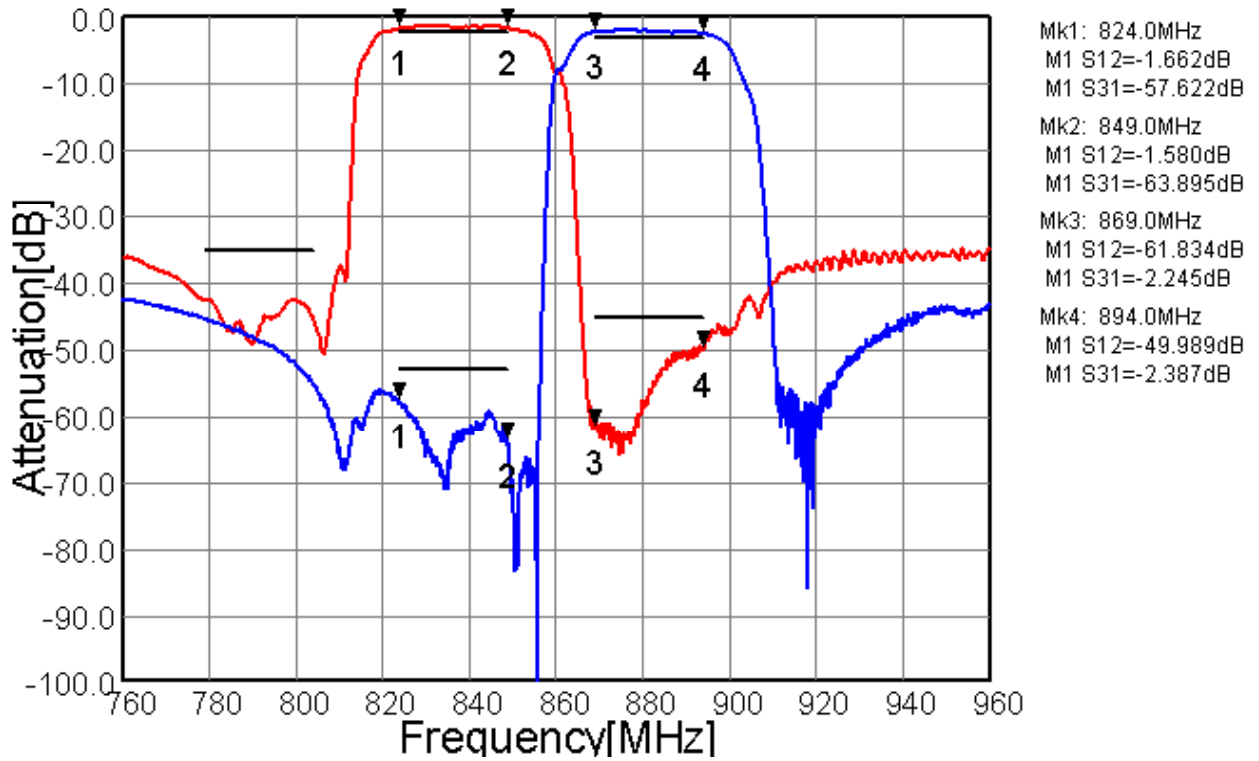

Fig.1 Pass Band Characteristics(Tx to Ant / Ant to Rx)

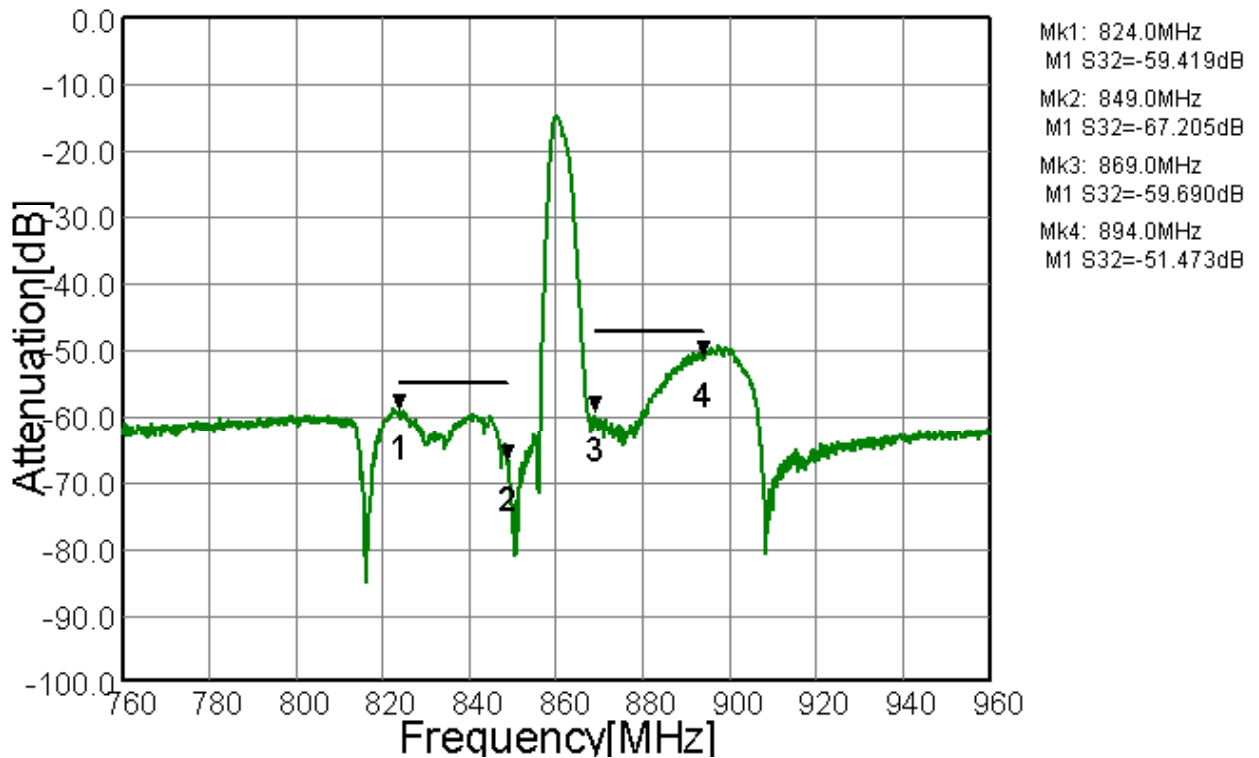

Fig.2 Tx to Rx Isolation Characteristics

Customer Name	Standard	FUJITSU MEDIA DEVICES LIMITED	
System	Cellular SAW Duplexer	DATE	Mar.10, 2006
FMD P/N	FAR-D5GA-881M50-D1AA	Version 4.1mia	

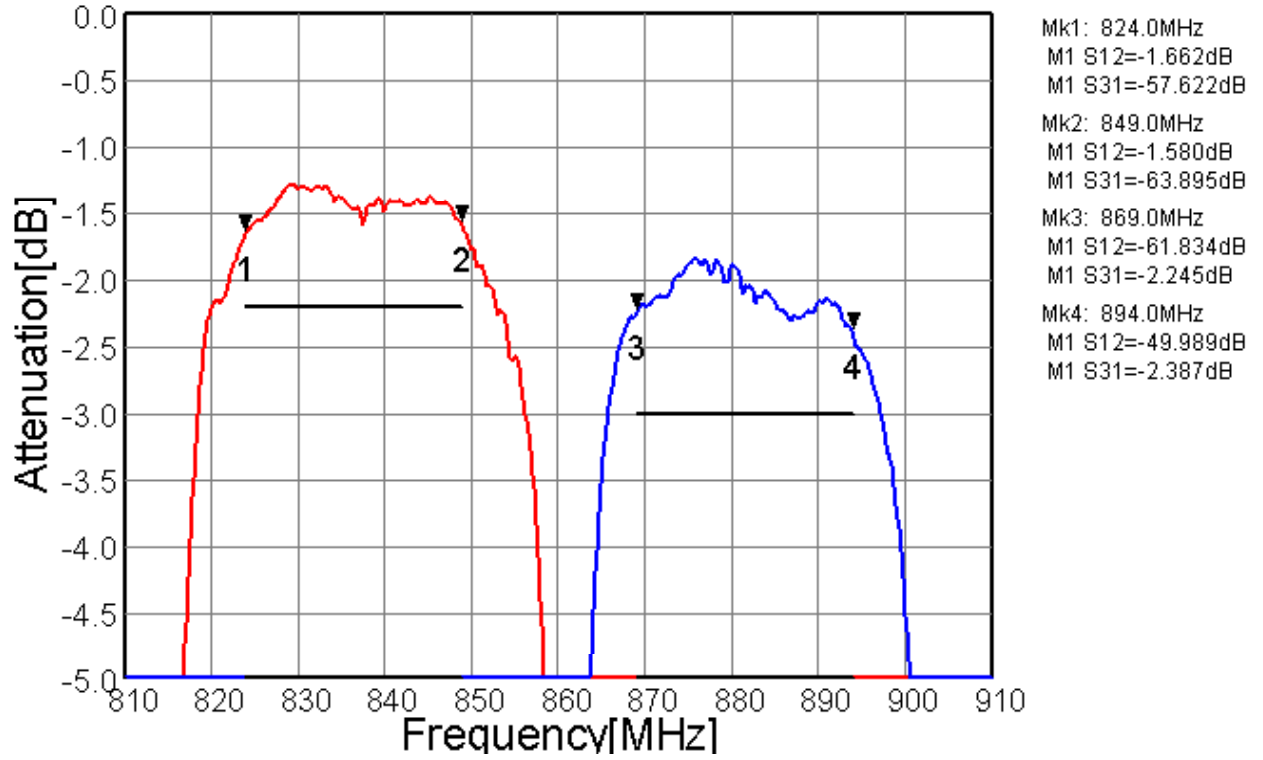

Fig.3 In-band Characteristics (Tx to Ant / Ant to Rx)

Customer Name	Standard	FUJITSU MEDIA DEVICES LIMITED	
System	Cellular SAW Duplexer	DATE	Mar.10, 2006
FMD P/N	FAR-D5GA-881M50-D1AA	Version 4.1mia	

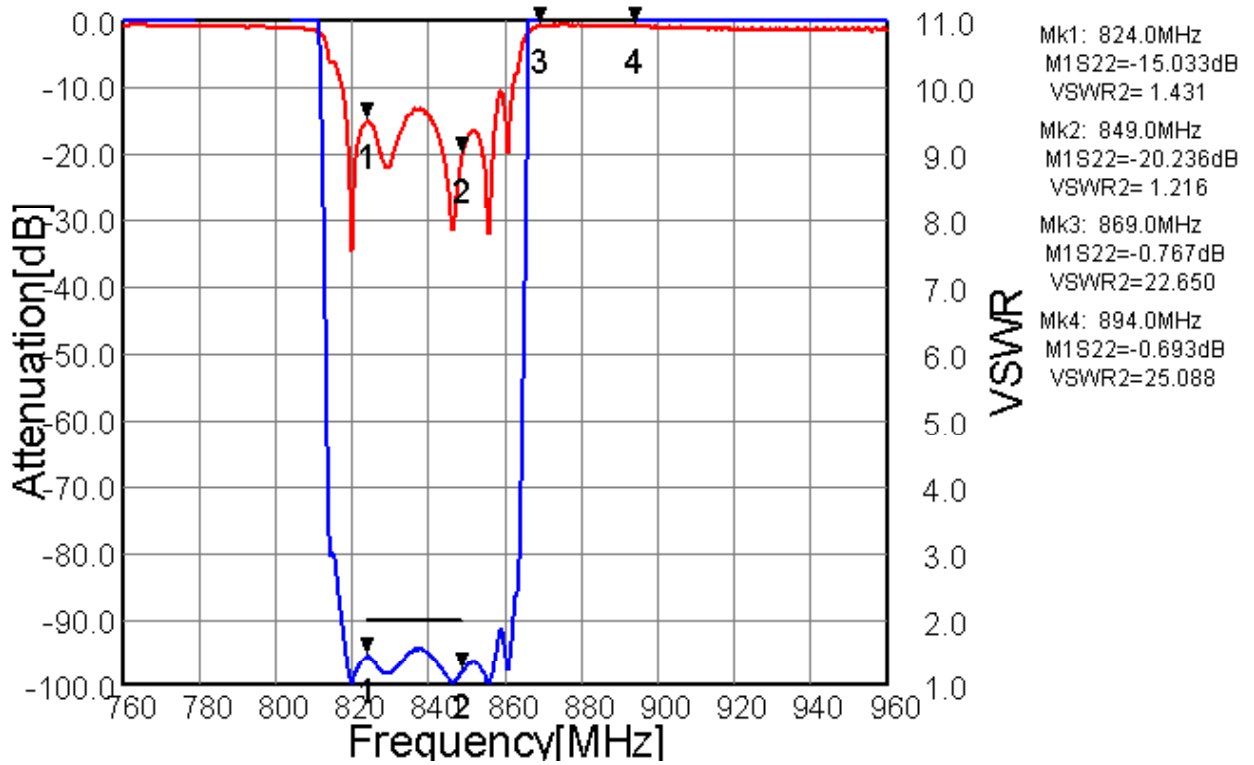

Fig.4 Return Loss / VSWR (Tx port)

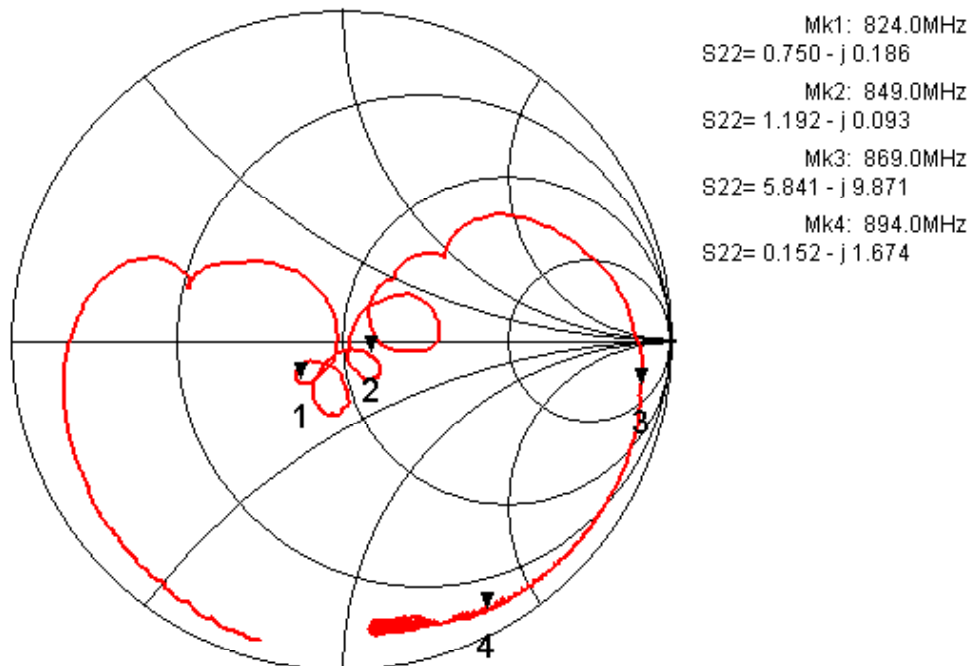

Fig.5 Impedance (Tx port)

Customer Name	Standard	FUJITSU MEDIA DEVICES LIMITED	
System	Cellular SAW Duplexer	DATE	Mar.10, 2006
FMD P/N	FAR-D5GA-881M50-D1AA	Version 4.1mia	

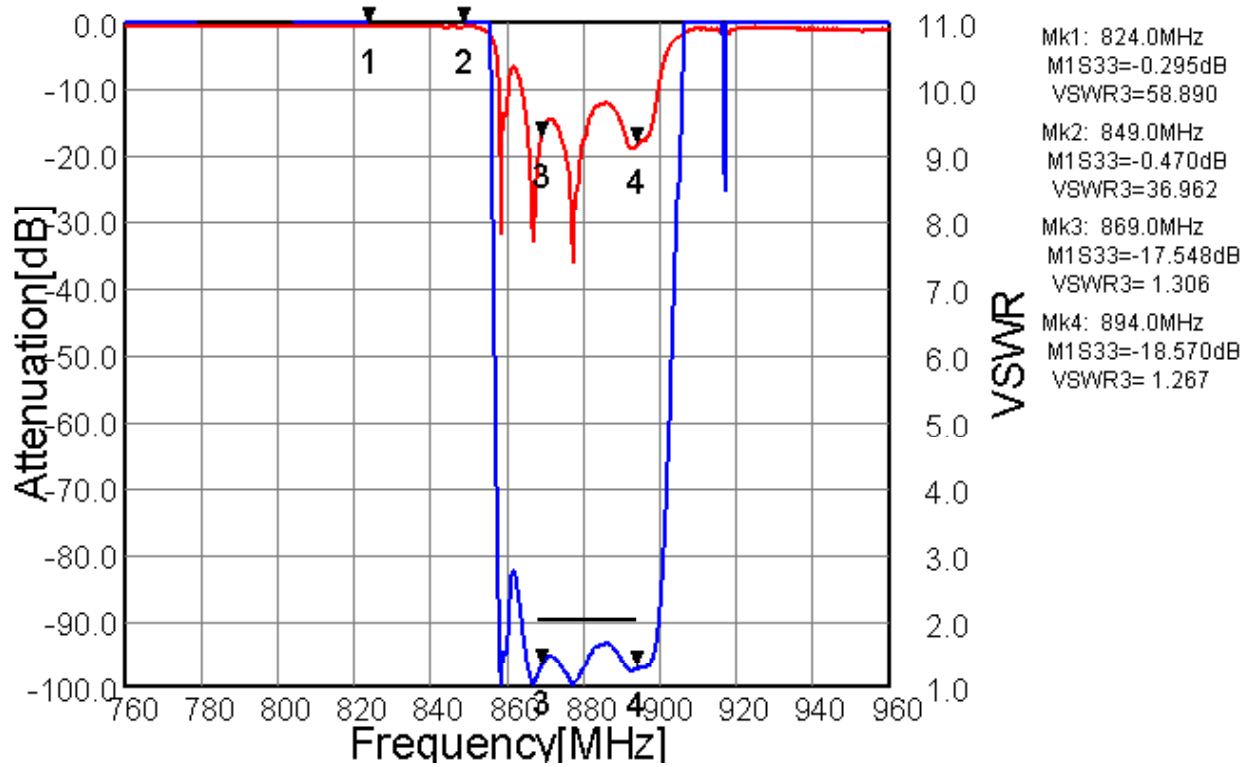

Fig.6 Return Loss / VSWR (Rx port)

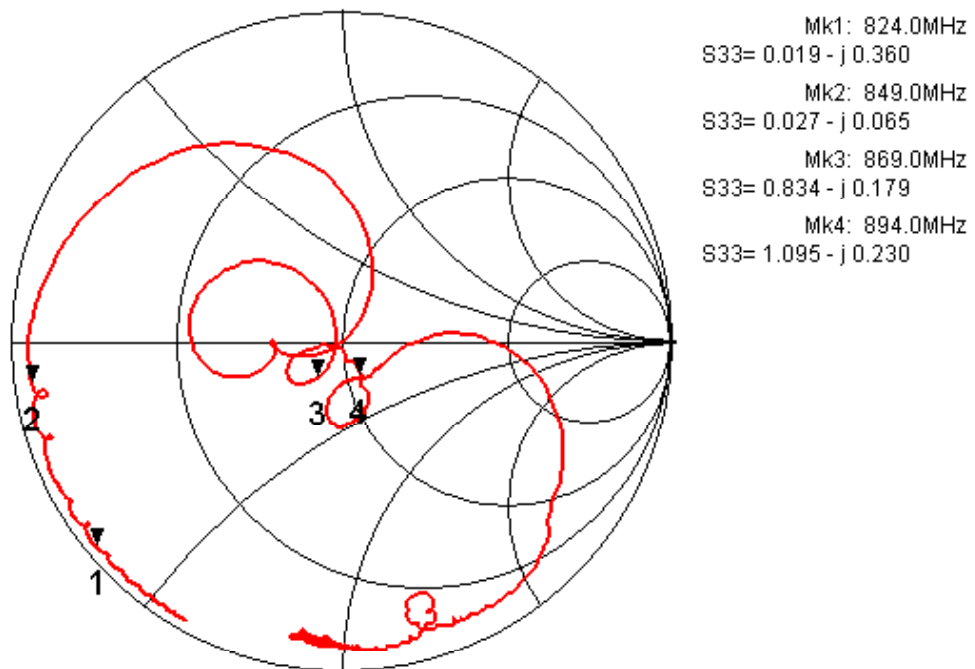

Fig.7 Impedance (Rx port)

Customer Name	Standard	FUJITSU MEDIA DEVICES LIMITED	
System	Cellular SAW Duplexer	DATE	Mar.10, 2006
FMD P/N	FAR-D5GA-881M50-D1AA	Version 4.1mia	

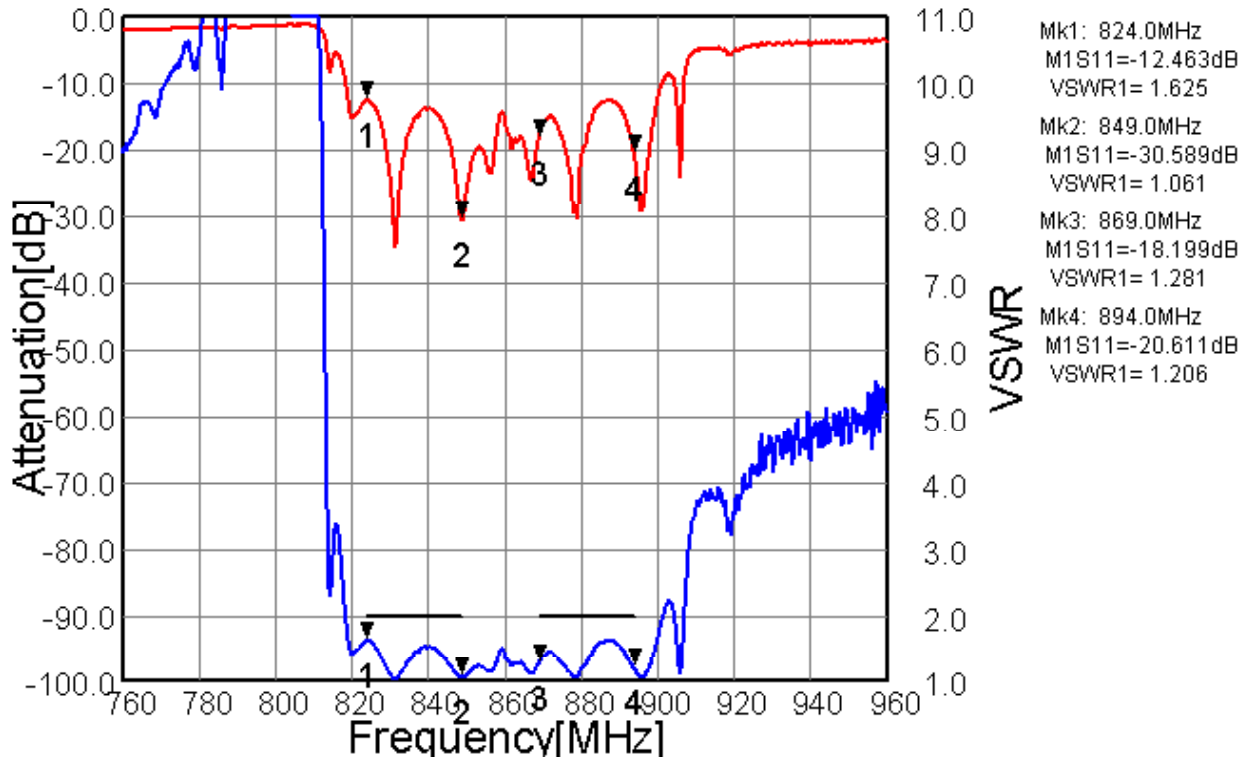

Fig.8 Return Loss / VSWR (Antenna port)

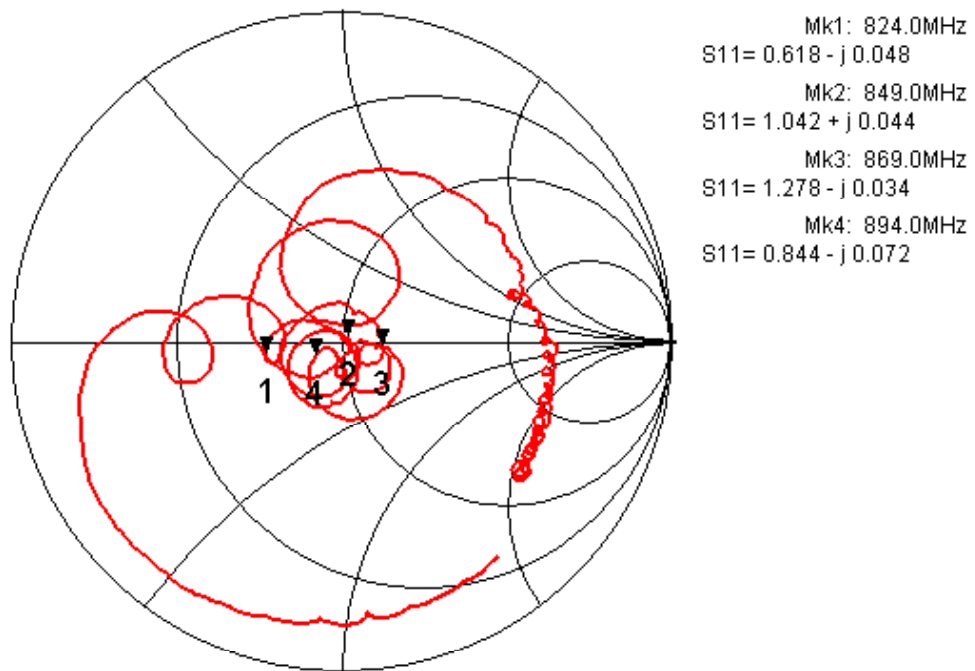

Fig.9 Impedance (Antenna port)

Customer Name	Standard	FUJITSU MEDIA DEVICES LIMITED	
System	Cellular SAW Duplexer	DATE	Mar.10, 2006
FMD P/N	FAR-D5GA-881M50-D1AA	Version 4.1mia	

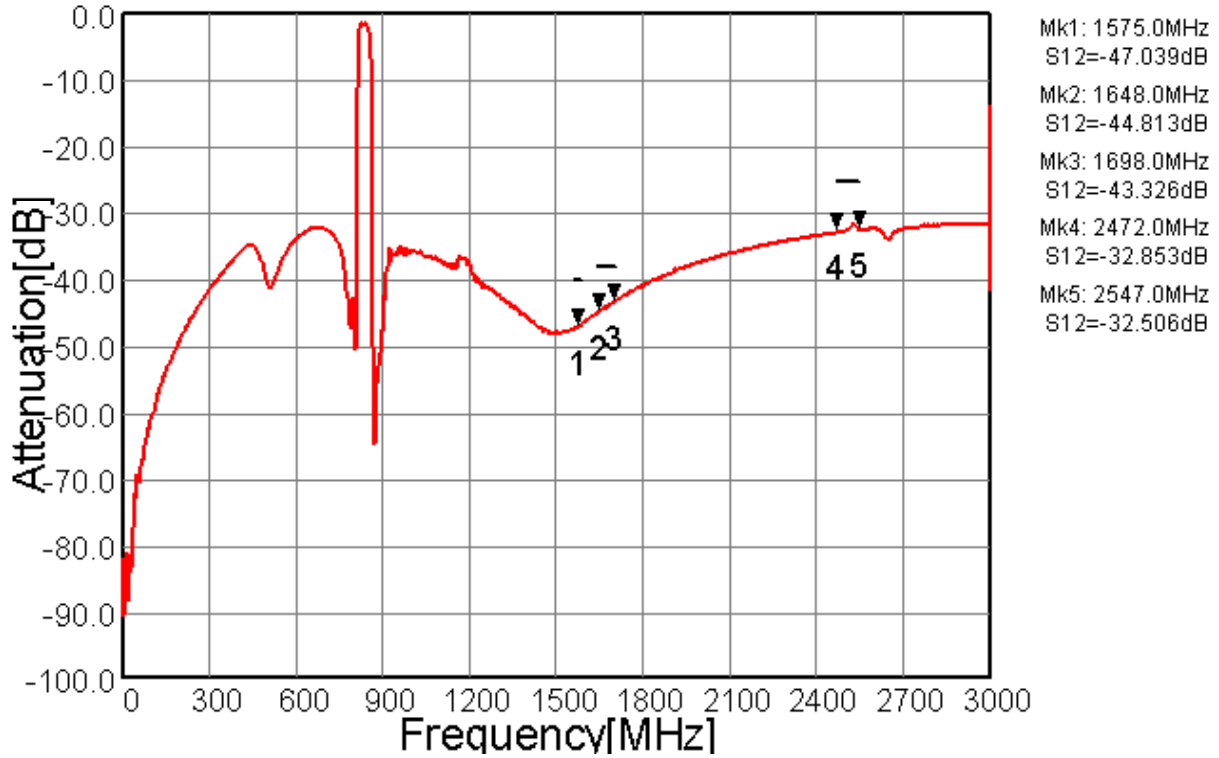

Fig.10 Wide-band Characteristics (Tx to Ant)

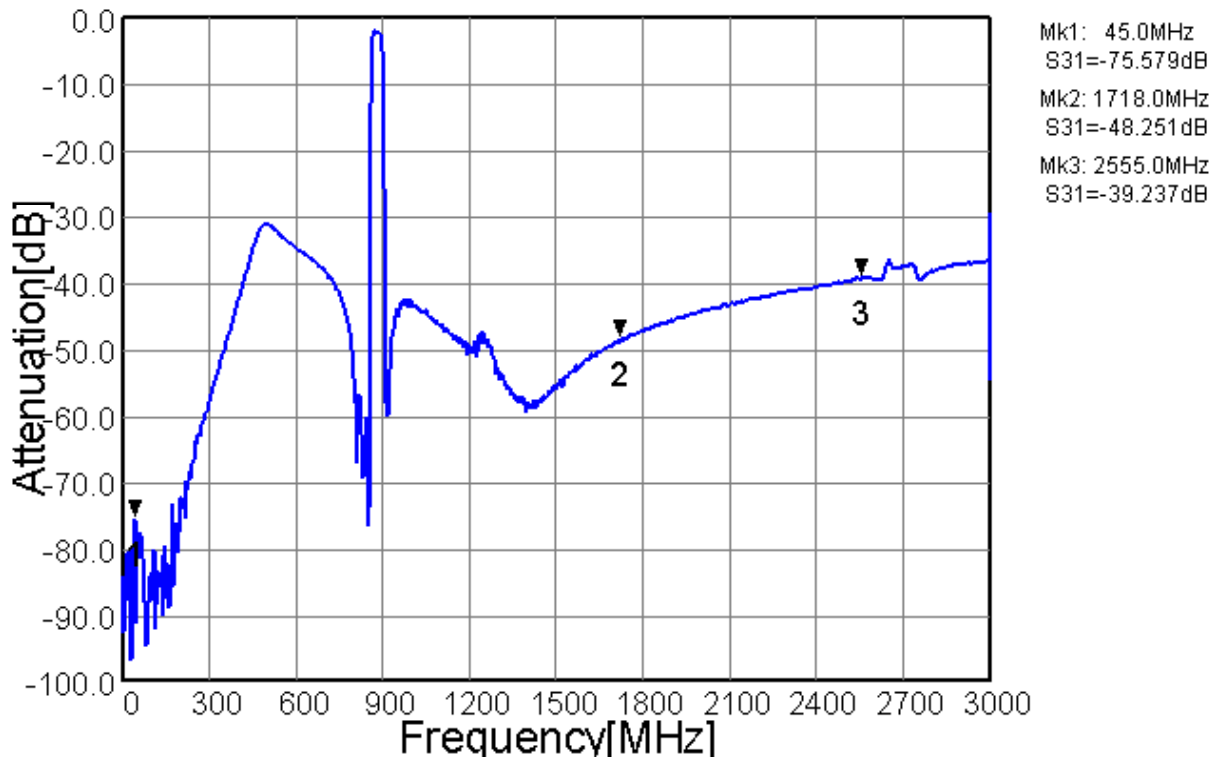

Fig.11 Wide-band Characteristics (Ant to Rx)

Customer Name	Standard	FUJITSU MEDIA DEVICES LIMITED	
System	Cellular SAW Duplexer	DATE	Mar.10, 2006
FMD P/N	FAR-D5GA-881M50-D1AA	Version 4.1mia	

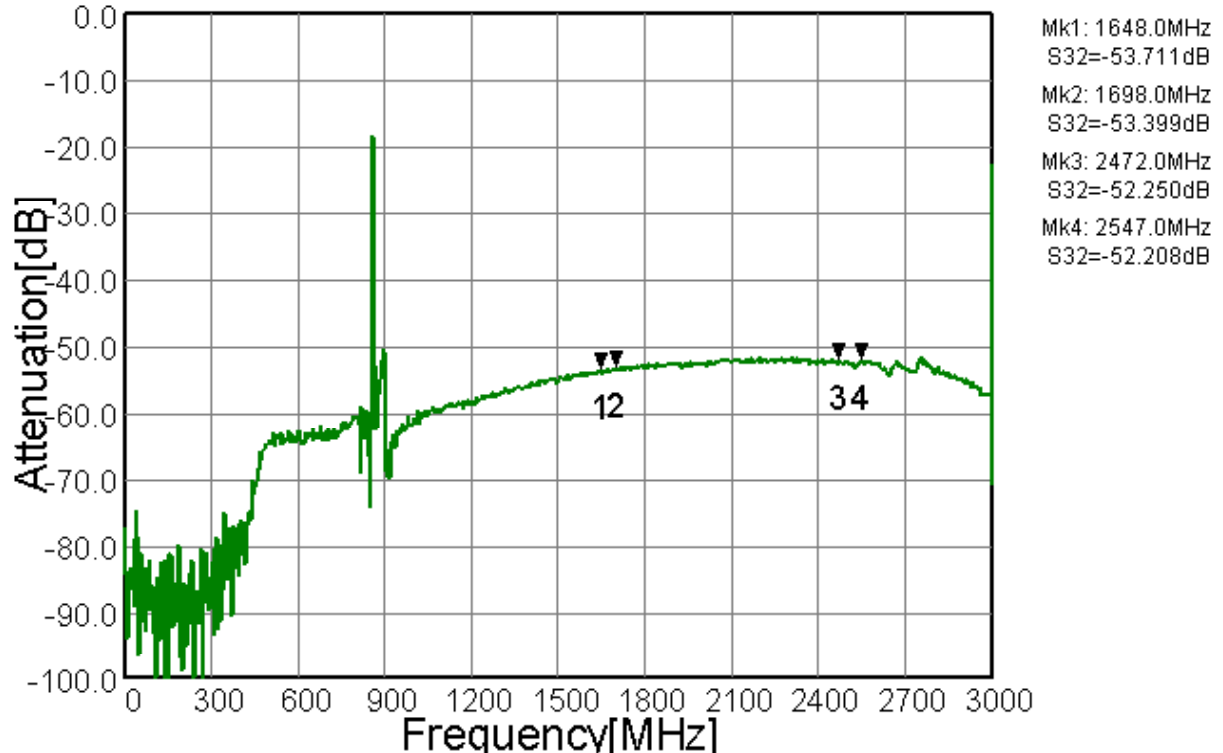

Fig.12 Wide-band Characteristics (Tx to Rx Isolation)

Customer Name	Standard	FUJITSU MEDIA DEVICES LIMITED	
System	Cellular SAW Duplexer	DATE	Mar.10, 2006
FMD P/N	FAR-D5GA-881M50-D1AA	Version 4.1mia	

Measuring Condition

