

## 2GB Unbuffered DDR2 SDRAM DIMM

### EBE21EE8ACWA (256M words × 72 bits, 2 Ranks)

---

#### Specifications

- Density: 2GB
- Organization
  - 256M words × 72 bits, 2 ranks
- Mounting 18 pieces of 1G bits DDR2 SDRAM sealed in FBGA
- Package: 240-pin socket type dual in line memory module (DIMM)
  - PCB height: 30.0mm
  - Lead pitch: 1.0mm
  - Lead-free (RoHS compliant)
- Power supply: VDD = 1.8V ± 0.1V
- Data rate: 800Mbps/667Mbps (max.)
- Eight internal banks for concurrent operation (components)
- Interface: SSTL\_18
- Burst lengths (BL): 4, 8
- /CAS Latency (CL): 3, 4, 5, 6
- Precharge: auto precharge option for each burst access
- Refresh: auto-refresh, self-refresh
- Refresh cycles: 8192 cycles/64ms
  - Average refresh period
    - 7.8μs at 0°C ≤ TC ≤ +85°C
    - 3.9μs at +85°C < TC ≤ +95°C
- Operating case temperature range
  - TC = 0°C to +95°C

#### Features

- Double-data-rate architecture; two data transfers per clock cycle
- The high-speed data transfer is realized by the 4 bits prefetch pipelined architecture
- Bi-directional differential data strobe (DQS and /DQS) is transmitted/received with data for capturing data at the receiver
- DQS is edge-aligned with data for READs; center-aligned with data for WRITEs
- Differential clock inputs (CK and /CK)
- DLL aligns DQ and DQS transitions with CK transitions
- Commands entered on each positive CK edge; data and data mask referenced to both edges of DQS
- Data mask (DM) for write data
- Posted /CAS by programmable additive latency for better command and data bus efficiency
- Off-Chip-Driver Impedance Adjustment and On-Die-Termination for better signal quality
- /DQS can be disabled for single-ended Data Strobe operation

## Ordering Information

| Part number       | Data rate Mbps (max.) | Component JEDEC speed bin (CL-tRCD-tRP) | Package                  | Contact pad | Mounted devices                      |
|-------------------|-----------------------|---|--------------------------|-------------|--------------------------------------|
| EBE21EE8ACWA-8E-E | 800                   | DDR2-800 (5-5-5)                        | 240-pin DIMM (lead-free) | Gold        | EDE1108ACBG-8E-E                     |
| EBE21EE8ACWA-8G-E |                       | DDR2-800 (6-6-6)                        |                          |             | EDE1108ACBG-8E-E                     |
| EBE21EE8ACWA-6E-E | 667                   | DDR2-667 (5-5-5)                        |                          |             | EDE1108ACBG-8E-E<br>EDE1108ACBG-6E-E |

## Pin Configurations

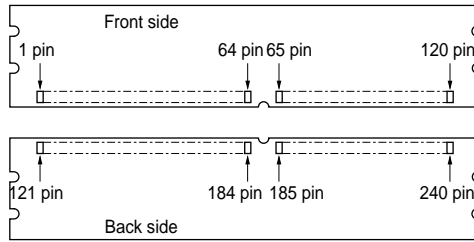

| Pin No. | Pin name | Pin No. | Pin name | Pin No. | Pin name | Pin No. | Pin name |
|---------|----------|---------|----------|---------|----------|---------|----------|
| 1       | VREF     | 61      | A4       | 121     | VSS      | 181     | VDD      |
| 2       | VSS      | 62      | VDD      | 122     | DQ4      | 182     | A3       |
| 3       | DQ0      | 63      | A2       | 123     | DQ5      | 183     | A1       |
| 4       | DQ1      | 64      | VDD      | 124     | VSS      | 184     | VDD      |
| 5       | VSS      | 65      | VSS      | 125     | DM0      | 185     | CK0      |
| 6       | /DQS0    | 66      | VSS      | 126     | NC       | 186     | /CK0     |
| 7       | DQS0     | 67      | VDD      | 127     | VSS      | 187     | VDD      |
| 8       | VSS      | 68      | NC       | 128     | DQ6      | 188     | A0       |
| 9       | DQ2      | 69      | VDD      | 129     | DQ7      | 189     | VDD      |
| 10      | DQ3      | 70      | A10/AP   | 130     | VSS      | 190     | BA1      |
| 11      | VSS      | 71      | BA0      | 131     | DQ12     | 191     | VDD      |
| 12      | DQ8      | 72      | VDD      | 132     | DQ13     | 192     | /RAS     |
| 13      | DQ9      | 73      | /WE      | 133     | VSS      | 193     | /CS0     |
| 14      | VSS      | 74      | /CAS     | 134     | DM1      | 194     | VDD      |
| 15      | /DQS1    | 75      | VDD      | 135     | NC       | 195     | ODT0     |
| 16      | DQS1     | 76      | /CS1     | 136     | VSS      | 196     | A13      |
| 17      | VSS      | 77      | ODT1     | 137     | CK1      | 197     | VDD      |
| 18      | NC       | 78      | VDD      | 138     | /CK1     | 198     | VSS      |
| 19      | NC       | 79      | VSS      | 139     | VSS      | 199     | DQ36     |
| 20      | VSS      | 80      | DQ32     | 140     | DQ14     | 200     | DQ37     |
| 21      | DQ10     | 81      | DQ33     | 141     | DQ15     | 201     | VSS      |
| 22      | DQ11     | 82      | VSS      | 142     | VSS      | 202     | DM4      |
| 23      | VSS      | 83      | /DQS4    | 143     | DQ20     | 203     | NC       |
| 24      | DQ16     | 84      | DQS4     | 144     | DQ21     | 204     | VSS      |
| 25      | DQ17     | 85      | VSS      | 145     | VSS      | 205     | DQ38     |
| 26      | VSS      | 86      | DQ34     | 146     | DM2      | 206     | DQ39     |
| 27      | /DQS2    | 87      | DQ35     | 147     | NC       | 207     | VSS      |

| Pin No. | Pin name | Pin No. | Pin name | Pin No. | Pin name | Pin No. | Pin name |
|---------|----------|---------|----------|---------|----------|---------|----------|
| 28      | DQS2     | 88      | VSS      | 148     | VSS      | 208     | DQ44     |
| 29      | VSS      | 89      | DQ40     | 149     | DQ22     | 209     | DQ45     |
| 30      | DQ18     | 90      | DQ41     | 150     | DQ23     | 210     | VSS      |
| 31      | DQ19     | 91      | VSS      | 151     | VSS      | 211     | DM5      |
| 32      | VSS      | 92      | /DQS5    | 152     | DQ28     | 212     | NC       |
| 33      | DQ24     | 93      | DQS5     | 153     | DQ29     | 213     | VSS      |
| 34      | DQ25     | 94      | VSS      | 154     | VSS      | 214     | DQ46     |
| 35      | VSS      | 95      | DQ42     | 155     | DM3      | 215     | DQ47     |
| 36      | /DQS3    | 96      | DQ43     | 156     | NC       | 216     | VSS      |
| 37      | DQS3     | 97      | VSS      | 157     | VSS      | 217     | DQ52     |
| 38      | VSS      | 98      | DQ48     | 158     | DQ30     | 218     | DQ53     |
| 39      | DQ26     | 99      | DQ49     | 159     | DQ31     | 219     | VSS      |
| 40      | DQ27     | 100     | VSS      | 160     | VSS      | 220     | CK2      |
| 41      | VSS      | 101     | SA2      | 161     | CB4      | 221     | /CK2     |
| 42      | CB0      | 102     | NC       | 162     | CB5      | 222     | VSS      |
| 43      | CB1      | 103     | VSS      | 163     | VSS      | 223     | DM6      |
| 44      | VSS      | 104     | /DQS6    | 164     | DM8      | 224     | NC       |
| 45      | /DQS8    | 105     | DQS6     | 165     | NC       | 225     | VSS      |
| 46      | DQS8     | 106     | VSS      | 166     | VSS      | 226     | DQ54     |
| 47      | VSS      | 107     | DQ50     | 167     | CB6      | 227     | DQ55     |
| 48      | CB2      | 108     | DQ51     | 168     | CB7      | 228     | VSS      |
| 49      | CB3      | 109     | VSS      | 169     | VSS      | 229     | DQ60     |
| 50      | VSS      | 110     | DQ56     | 170     | VDD      | 230     | DQ61     |
| 51      | VDD      | 111     | DQ57     | 171     | CKE1     | 231     | VSS      |
| 52      | CKE0     | 112     | VSS      | 172     | VDD      | 232     | DM7      |
| 53      | VDD      | 113     | /DQS7    | 173     | NC       | 233     | NC       |
| 54      | BA2      | 114     | DQS7     | 174     | NC       | 234     | VSS      |
| 55      | NC       | 115     | VSS      | 175     | VDD      | 235     | DQ62     |
| 56      | VDD      | 116     | DQ58     | 176     | A12      | 236     | DQ63     |
| 57      | A11      | 117     | DQ59     | 177     | A9       | 237     | VSS      |
| 58      | A7       | 118     | VSS      | 178     | VDD      | 238     | VDDSPD   |
| 59      | VDD      | 119     | SDA      | 179     | A8       | 239     | SA0      |
| 60      | A5       | 120     | SCL      | 180     | A6       | 240     | SA1      |

**Pin Description**

| Pin name                     | Function  |
|------------------------------|---|
| A0 to A13                    | Address input<br>Row address A0 to A13<br>Column address A0 to A9 |
| A10 (AP)                     | Auto precharge  |
| BA0, BA1, BA2                | Bank select address   |
| DQ0 to DQ63                  | Data input/output   |
| CB0 to CB7                   | Check bit (Data input/output)                                     |
| /RAS                         | Row address strobe command  |
| /CAS                         | Column address strobe command                                     |
| /WE                          | Write enable  |
| /CS0, /CS1                   | Chip select   |
| CKE0, CKE1                   | Clock enable  |
| CK0 to CK2                   | Clock input   |
| /CK0 to /CK2                 | Differential clock input  |
| DQS0 to DQS8, /DQS0 to /DQS8 | Input and output data strobe                                      |
| DM0 to DM8                   | Input mask  |
| SCL                          | Clock input for serial PD   |
| SDA                          | Data input/output for serial PD                                   |
| SA0 to SA2                   | Serial address input  |
| VDD                          | Power for internal circuit  |
| VDDSPD                       | Power for serial EEPROM   |
| VREF                         | Input reference voltage   |
| VSS                          | Ground  |
| ODT0, ODT1                   | ODT control   |
| NC                           | No connection   |

**Serial PD Matrix**

| Byte No. | Function described  | Bit7 | Bit6 | Bit5 | Bit4 | Bit3 | Bit2 | Bit1 | Bit0 | Hex value | Comments                       |
|----------|---|------|------|------|------|------|------|------|------|-----------|--------------------------------|
| 0        | Number of bytes utilized by module manufacturer                           | 1    | 0    | 0    | 0    | 0    | 0    | 0    | 0    | 80H       | 128 bytes                      |
| 1        | Total number of bytes in serial PD device                                 | 0    | 0    | 0    | 0    | 1    | 0    | 0    | 0    | 08H       | 256 bytes                      |
| 2        | Memory type   | 0    | 0    | 0    | 0    | 1    | 0    | 0    | 0    | 08H       | DDR2 SDRAM                     |
| 3        | Number of row address   | 0    | 0    | 0    | 0    | 1    | 1    | 1    | 0    | 0EH       | 14                             |
| 4        | Number of column address  | 0    | 0    | 0    | 0    | 1    | 0    | 1    | 0    | 0AH       | 10                             |
| 5        | Number of DIMM ranks  | 0    | 1    | 1    | 0    | 0    | 0    | 0    | 1    | 61H       | 2                              |
| 6        | Module data width   | 0    | 1    | 0    | 0    | 1    | 0    | 0    | 0    | 48H       | 72                             |
| 7        | Module data width continuation  | 0    | 0    | 0    | 0    | 0    | 0    | 0    | 0    | 00H       | 0                              |
| 8        | Voltage interface level of this assembly                                  | 0    | 0    | 0    | 0    | 0    | 1    | 0    | 1    | 05H       | SSTL 1.8V                      |
| 9        | DDR SDRAM cycle time, CL = X - 8E (CL = 5)                                | 0    | 0    | 1    | 0    | 0    | 1    | 0    | 1    | 25H       | 2.5ns*1                        |
|          | -8G (CL = 6)  | 0    | 0    | 1    | 0    | 0    | 1    | 0    | 1    | 25H       | 2.5ns*1                        |
|          | -6E (CL = 5)  | 0    | 0    | 1    | 1    | 0    | 0    | 0    | 0    | 30H       | 3.0ns*1                        |
| 10       | SDRAM access from clock (tAC) -8E, -8G                                    | 0    | 1    | 0    | 0    | 0    | 0    | 0    | 0    | 40H       | 0.4ns*1                        |
|          | -6E   | 0    | 1    | 0    | 0    | 0    | 1    | 0    | 1    | 45H       | 0.45ns*1                       |
| 11       | DIMM configuration type   | 0    | 0    | 0    | 0    | 0    | 0    | 1    | 0    | 02H       | ECC                            |
| 12       | Refresh rate/type   | 1    | 0    | 0    | 0    | 0    | 0    | 1    | 0    | 82H       | 7.8µs                          |
| 13       | Primary SDRAM width   | 0    | 0    | 0    | 0    | 1    | 0    | 0    | 0    | 08H       | × 8                            |
| 14       | Error checking SDRAM width  | 0    | 0    | 0    | 0    | 1    | 0    | 0    | 0    | 08H       | × 8                            |
| 15       | Reserved  | 0    | 0    | 0    | 0    | 0    | 0    | 0    | 0    | 00H       | 0                              |
| 16       | SDRAM device attributes: Burst length supported                           | 0    | 0    | 0    | 0    | 1    | 1    | 0    | 0    | 0CH       | 4,8                            |
| 17       | SDRAM device attributes: Number of banks on SDRAM device                  | 0    | 0    | 0    | 0    | 1    | 0    | 0    | 0    | 08H       | 8                              |
| 18       | SDRAM device attributes: /CAS latency -8E, -6E                            | 0    | 0    | 1    | 1    | 1    | 0    | 0    | 0    | 38H       | 3, 4, 5                        |
|          | -8G   | 0    | 1    | 1    | 1    | 0    | 0    | 0    | 0    | 70H       | 4, 5, 6                        |
| 19       | DIMM Mechanical Characteristics   | 0    | 0    | 0    | 0    | 0    | 0    | 0    | 1    | 01H       | 4.00mm max.                    |
| 20       | DIMM type information   | 0    | 0    | 0    | 0    | 0    | 0    | 1    | 0    | 02H       | Unbuffered                     |
| 21       | SDRAM module attributes   | 0    | 0    | 0    | 0    | 0    | 0    | 0    | 0    | 00H       | Normal                         |
| 22       | SDRAM device attributes: General  | 0    | 0    | 0    | 0    | 0    | 0    | 1    | 1    | 03H       | Weak Driver<br>50Ω ODT Support |
| 23       | Minimum clock cycle time at CL = X - 1 -8E, -6E (CL = 4)                  | 0    | 0    | 1    | 1    | 1    | 1    | 0    | 1    | 3DH       | 3.75ns*1                       |
|          | -8G (CL = 5)  | 0    | 0    | 1    | 1    | 0    | 0    | 0    | 0    | 30H       | 3.0ns*1                        |
| 24       | Maximum data access time (tAC) from clock at CL = X - 1 -8E, -6E (CL = 4) | 0    | 1    | 0    | 1    | 0    | 0    | 0    | 0    | 50H       | 0.5ns*1                        |
|          | -8G (CL = 5)  | 0    | 1    | 0    | 0    | 0    | 1    | 0    | 1    | 45H       | 0.45ns*1                       |
| 25       | Minimum clock cycle time at CL = X - 2 -8E, -6E (CL = 3)                  | 0    | 1    | 0    | 1    | 0    | 0    | 0    | 0    | 50H       | 5.0ns*1                        |
|          | -8G (CL = 4)  | 0    | 0    | 1    | 1    | 1    | 1    | 0    | 1    | 3DH       | 3.75ns*1                       |

| Byte No. | Function described  | Bit7 | Bit6 | Bit5 | Bit4 | Bit3 | Bit2 | Bit1 | Bit0 | Hex value | Comments              |
|----------|---|------|------|------|------|------|------|------|------|-----------|-----------------------|
| 26       | Maximum data access time (tAC)<br>from clock at CL = X – 2<br>-8E, -6E (CL = 3) | 0    | 1    | 1    | 0    | 0    | 0    | 0    | 0    | 60H       | 0.6ns* <sup>1</sup>   |
|          | -8G (CL = 4)  | 0    | 1    | 0    | 1    | 0    | 0    | 0    | 0    | 50H       | 0.5ns* <sup>1</sup>   |
| 27       | Minimum row precharge time (tRP)<br>-8E   | 0    | 0    | 1    | 1    | 0    | 0    | 1    | 0    | 32H       | 12.5ns                |
|          | -8G, -6E  | 0    | 0    | 1    | 1    | 1    | 1    | 0    | 0    | 3CH       | 15ns                  |
| 28       | Minimum row active to row active<br>delay (tRRD)                                | 0    | 0    | 0    | 1    | 1    | 1    | 1    | 0    | 1EH       | 7.5ns                 |
| 29       | Minimum /RAS to /CAS delay (tRCD)<br>-8E  | 0    | 0    | 1    | 1    | 0    | 0    | 1    | 0    | 32H       | 12.5ns                |
|          | -8G, -6E  | 0    | 0    | 1    | 1    | 1    | 1    | 0    | 0    | 3CH       | 15ns                  |
| 30       | Minimum active to precharge time<br>(tRAS)                                      | 0    | 0    | 1    | 0    | 1    | 1    | 0    | 1    | 2DH       | 45ns                  |
| 31       | Module rank density   | 0    | 0    | 0    | 0    | 0    | 0    | 0    | 1    | 01H       | 1G bytes              |
| 32       | Address and command setup time<br>before clock (tIS)<br>-8E, -8G                | 0    | 0    | 0    | 1    | 0    | 1    | 1    | 1    | 17H       | 0.17ns* <sup>1</sup>  |
|          | -6E   | 0    | 0    | 1    | 0    | 0    | 0    | 0    | 0    | 20H       | 0.20ns* <sup>1</sup>  |
| 33       | Address and command hold time<br>after clock (tIH)<br>-8E, -8G                  | 0    | 0    | 1    | 0    | 0    | 1    | 0    | 1    | 25H       | 0.25ns* <sup>1</sup>  |
|          | -6E   | 0    | 0    | 1    | 0    | 0    | 1    | 1    | 1    | 27H       | 0.27ns* <sup>1</sup>  |
| 34       | Data input setup time before clock<br>(tDS)<br>-8E, -8G                         | 0    | 0    | 0    | 0    | 0    | 1    | 0    | 1    | 05H       | 0.05ns* <sup>1</sup>  |
|          | -6E   | 0    | 0    | 0    | 1    | 0    | 0    | 0    | 0    | 10H       | 0.10ns* <sup>1</sup>  |
| 35       | Data input hold time after clock (tDH)<br>-8E, -8G                              | 0    | 0    | 0    | 1    | 0    | 0    | 1    | 0    | 12H       | 0.12ns* <sup>1</sup>  |
|          | -6E   | 0    | 0    | 0    | 1    | 0    | 1    | 1    | 1    | 17H       | 0.17ns* <sup>1</sup>  |
| 36       | Write recovery time (tWR)   | 0    | 0    | 1    | 1    | 1    | 1    | 0    | 0    | 3CH       | 15ns* <sup>1</sup>    |
| 37       | Internal write to read command delay<br>(tWTR)                                  | 0    | 0    | 0    | 1    | 1    | 1    | 1    | 0    | 1EH       | 7.5ns* <sup>1</sup>   |
| 38       | Internal read to precharge command<br>delay (tRTP)                              | 0    | 0    | 0    | 1    | 1    | 1    | 1    | 0    | 1EH       | 7.5ns* <sup>1</sup>   |
| 39       | Memory analysis probe<br>characteristics  | 0    | 0    | 0    | 0    | 0    | 0    | 0    | 0    | 00H       | TBD                   |
| 40       | Extension of Byte 41 and 42<br>-8E  | 0    | 0    | 1    | 1    | 0    | 1    | 1    | 0    | 36H       |                       |
|          | -8G, -6E  | 0    | 0    | 0    | 0    | 0    | 1    | 1    | 0    | 06H       |                       |
| 41       | Active command period (tRC)<br>-8E  | 0    | 0    | 1    | 1    | 1    | 0    | 0    | 1    | 39H       | 57.5ns* <sup>1</sup>  |
|          | -8G, -6E  | 0    | 0    | 1    | 1    | 1    | 1    | 0    | 0    | 3CH       | 60ns* <sup>1</sup>    |
| 42       | Auto refresh to active/<br>Auto refresh command cycle (tRFC)                    | 0    | 1    | 1    | 1    | 1    | 1    | 1    | 1    | 7FH       | 127.5ns* <sup>1</sup> |
| 43       | SDRAM tCK cycle max. (tCK max.)   | 1    | 0    | 0    | 0    | 0    | 0    | 0    | 0    | 80H       | 8ns* <sup>1</sup>     |
| 44       | Dout to DQS skew<br>-8E, -8G  | 0    | 0    | 0    | 1    | 0    | 1    | 0    | 0    | 14H       | 0.20ns* <sup>1</sup>  |
|          | -6E   | 0    | 0    | 0    | 1    | 1    | 0    | 0    | 0    | 18H       | 0.24ns* <sup>1</sup>  |
| 45       | Data hold skew (tQHS)<br>-8E, -8G   | 0    | 0    | 0    | 1    | 1    | 1    | 1    | 0    | 1EH       | 0.30ns* <sup>1</sup>  |
|          | -6E   | 0    | 0    | 1    | 0    | 0    | 0    | 1    | 0    | 22H       | 0.34ns* <sup>1</sup>  |
| 46       | PLL relock time   | 0    | 0    | 0    | 0    | 0    | 0    | 0    | 0    | 00H       | Undefined             |

| Byte No.  | Function described                | Bit7 | Bit6 | Bit5 | Bit4 | Bit3 | Bit2 | Bit1 | Bit0 | Hex value | Comments          |
|-----------|-----------------------------------|------|------|------|------|------|------|------|------|-----------|-------------------|
| 47 to 61  |                                   | 0    | 0    | 0    | 0    | 0    | 0    | 0    | 0    | 00H       |                   |
| 62        | SPD Revision                      | 0    | 0    | 0    | 1    | 0    | 0    | 1    | 0    | 12H       | Rev. 1.2          |
| 63        | Checksum for bytes 0 to 62<br>-8E | 0    | 0    | 0    | 0    | 1    | 0    | 1    | 1    | 0BH       |                   |
|           | -8G                               | 1    | 1    | 1    | 0    | 1    | 1    | 1    | 1    | EFH       |                   |
|           | -6E                               | 0    | 0    | 1    | 0    | 0    | 1    | 0    | 1    | 25H       |                   |
| 64 to 65  | Manufacturer's JEDEC ID code      | 0    | 1    | 1    | 1    | 1    | 1    | 1    | 1    | 7FH       | Continuation code |
| 66        | Manufacturer's JEDEC ID code      | 1    | 1    | 1    | 1    | 1    | 1    | 1    | 0    | FEH       | Elpida Memory     |
| 67 to 71  | Manufacturer's JEDEC ID code      | 0    | 0    | 0    | 0    | 0    | 0    | 0    | 0    | 00H       |                   |
| 72        | Manufacturing location            | ×    | ×    | ×    | ×    | ×    | ×    | ×    | ×    | ×         | (ASCII-8bit code) |
| 73        | Module part number                | 0    | 1    | 0    | 0    | 0    | 1    | 0    | 1    | 45H       | E                 |
| 74        | Module part number                | 0    | 1    | 0    | 0    | 0    | 0    | 1    | 0    | 42H       | B                 |
| 75        | Module part number                | 0    | 1    | 0    | 0    | 0    | 1    | 0    | 1    | 45H       | E                 |
| 76        | Module part number                | 0    | 0    | 1    | 1    | 0    | 0    | 1    | 0    | 32H       | 2                 |
| 77        | Module part number                | 0    | 0    | 1    | 1    | 0    | 0    | 0    | 1    | 31H       | 1                 |
| 78        | Module part number                | 0    | 1    | 0    | 0    | 0    | 1    | 0    | 1    | 45H       | E                 |
| 79        | Module part number                | 0    | 1    | 0    | 0    | 0    | 1    | 0    | 1    | 45H       | E                 |
| 80        | Module part number                | 0    | 0    | 1    | 1    | 1    | 0    | 0    | 0    | 38H       | 8                 |
| 81        | Module part number                | 0    | 1    | 0    | 0    | 0    | 0    | 0    | 1    | 41H       | A                 |
| 82        | Module part number                | 0    | 1    | 0    | 0    | 0    | 0    | 1    | 1    | 43H       | C                 |
| 83        | Module part number                | 0    | 1    | 0    | 1    | 0    | 1    | 1    | 1    | 57H       | W                 |
| 84        | Module part number                | 0    | 1    | 0    | 0    | 0    | 0    | 0    | 1    | 41H       | A                 |
| 85        | Module part number                | 0    | 0    | 1    | 0    | 1    | 1    | 0    | 1    | 2DH       | —                 |
| 86        | Module part number<br>-8E, -8G    | 0    | 0    | 1    | 1    | 1    | 0    | 0    | 0    | 38H       | 8                 |
|           | -6E                               | 0    | 0    | 1    | 1    | 0    | 1    | 1    | 0    | 36H       | 6                 |
| 87        | Module part number<br>-8E, -6E    | 0    | 1    | 0    | 0    | 0    | 1    | 0    | 1    | 45H       | E                 |
|           | -8G                               | 0    | 1    | 0    | 0    | 0    | 1    | 1    | 1    | 47H       | G                 |
| 88        | Module part number                | 0    | 0    | 1    | 0    | 1    | 1    | 0    | 1    | 2DH       | —                 |
| 89        | Module part number                | 0    | 1    | 0    | 0    | 0    | 1    | 0    | 1    | 45H       | E                 |
| 90        | Module part number                | 0    | 0    | 1    | 0    | 0    | 0    | 0    | 0    | 20H       | (Space)           |
| 91        | Revision code                     | 0    | 0    | 1    | 1    | 0    | 0    | 0    | 0    | 30H       | Initial           |
| 92        | Revision code                     | 0    | 0    | 1    | 0    | 0    | 0    | 0    | 0    | 20H       | (Space)           |
| 93        | Manufacturing date                | ×    | ×    | ×    | ×    | ×    | ×    | ×    | ×    | ×         | Year code (BCD)   |
| 94        | Manufacturing date                | ×    | ×    | ×    | ×    | ×    | ×    | ×    | ×    | ×         | Week code (BCD)   |
| 95 to 98  | Module serial number              |      |      |      |      |      |      |      |      |           |                   |
| 99 to 127 | Manufacture specific data         |      |      |      |      |      |      |      |      |           |                   |

Note 1: These specifications are defined based on component specification, not module.

Block Diagram

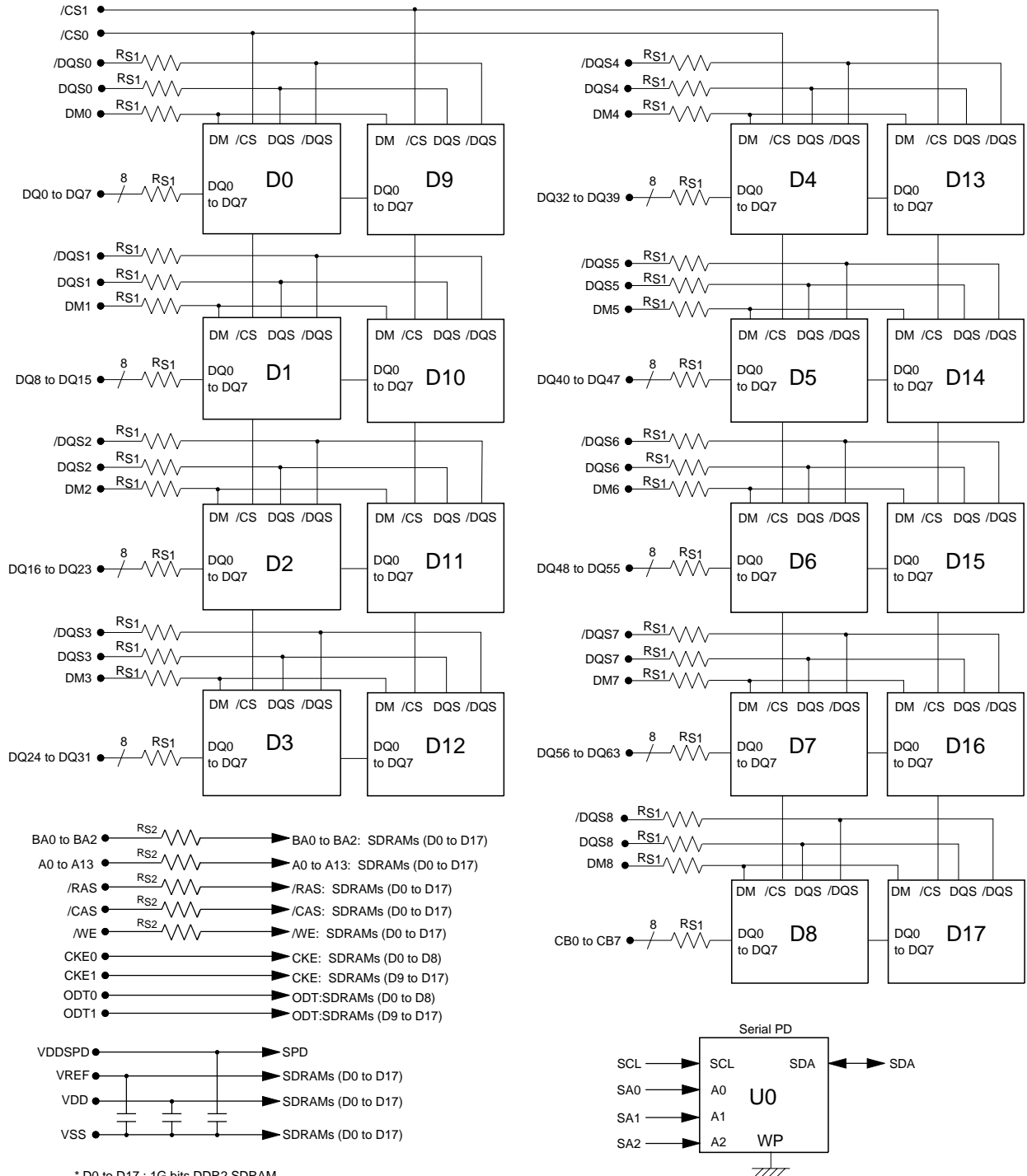

\* D0 to D17 : 1G bits DDR2 SDRAM  
 U0 : 2k bits EEPROM  
 Rs1 : 22Ω  
 Rs2 : 7.5Ω

- Notes :
1. DQ wiring may be changed within a byte.
  2. DQ, DQS, /DQS, ODT, DM, CKE, /CS relationships must be maintained as shown.
  3. Refer to the appropriate clock wiring topology under the DIMM wiring details section of this document.



Logical Clock Net Structure

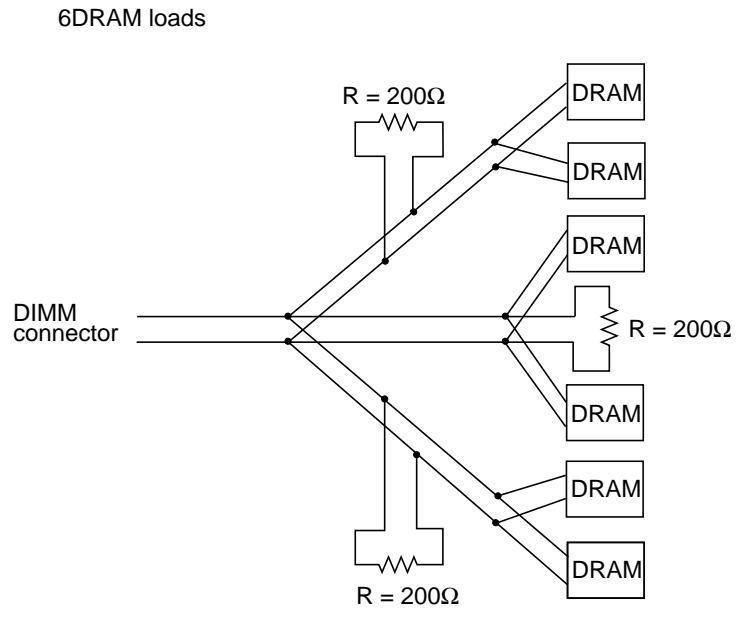

**Electrical Specifications**

- All voltages are referenced to VSS (GND).

**Absolute Maximum Ratings**

| Parameter                          | Symbol | Value        | Unit | Notes |
|------------------------------------|--------|--------------|------|-------|
| Voltage on any pin relative to VSS | VT     | -0.5 to +2.3 | V    | 1     |
| Supply voltage relative to VSS     | VDD    | -0.5 to +2.3 | V    |       |
| Short circuit output current       | IOS    | 50           | mA   | 1     |
| Power dissipation                  | PD     | 9            | W    |       |
| Operating case temperature         | TC     | 0 to +95     | °C   | 1, 2  |
| Storage temperature                | Tstg   | -55 to +100  | °C   | 1     |

Notes: 1. DDR2 SDRAM component specification.

2. Supporting 0°C to +85°C and being able to extend to +95°C with doubling auto-refresh commands in frequency to a 32ms period (tREFI = 3.9µs) and higher temperature self-refresh entry via the control of EMRS (2) bit A7 is required.

**Caution** Exposing the device to stress above those listed in Absolute Maximum Ratings could cause permanent damage. The device is not meant to be operated under conditions outside the limits described in the operational section of this specification Exposure to Absolute Maximum Rating conditions for extended periods may affect device reliability.

**DC Operating Conditions (TC = 0°C to +85°C) (DDR2 SDRAM Component Specification)**

| Parameter               | Symbol    | min.         | typ.        | max.         | Unit | Notes |
|-------------------------|-----------|--------------|-------------|--------------|------|-------|
| Supply voltage          | VDD, VDDQ | 1.7          | 1.8         | 1.9          | V    | 4     |
|                         | VSS       | 0            | 0           | 0            | V    |       |
|                         | VDDSPD    | 1.7          | —           | 3.6          | V    |       |
| Input reference voltage | VREF      | 0.49 × VDDQ  | 0.50 × VDDQ | 0.51 × VDDQ  | V    | 1, 2  |
| Termination voltage     | VTT       | VREF - 0.04  | VREF        | VREF + 0.04  | V    | 3     |
| DC input logic high     | VIH (DC)  | VREF + 0.125 | —           | VDDQ + 0.3   | V    |       |
| DC input low            | VIL (DC)  | -0.3         | —           | VREF - 0.125 | V    |       |
| AC input logic high     | VIH (AC)  | VREF + 0.200 | —           | —            | V    |       |
| AC input low            | VIL (AC)  | —            | —           | VREF - 0.200 | V    |       |

Notes: 1. The value of VREF may be selected by the user to provide optimum noise margin in the system. Typically the value of VREF is expected to be about 0.5 × VDDQ of the transmitting device and VREF are expected to track variations in VDDQ.

2. Peak to peak AC noise on VREF may not exceed ±2% VREF (DC).
3. VTT of transmitting device must track VREF of receiving device.
4. VDDQ must be equal to VDD.

**AC Overshoot/Undershoot Specification (DDR2 SDRAM Component Specification)**

| Parameter                                     | Pins                         | Specification | Unit |
|---|------------------------------|---------------|------|
| Maximum peak amplitude allowed for overshoot  | Command, Address, CKE, ODT   | 0.5           | V    |
| Maximum peak amplitude allowed for undershoot |                              | 0.5           | V    |
| Maximum overshoot area above VDD<br>DDR2-800  |                              | 0.66          | V-ns |
| DDR2-667                                      |                              | 0.8           | V-ns |
| Maximum undershoot area below VSS<br>DDR2-800 |                              | 0.66          | V-ns |
| DDR2-667                                      |                              | 0.8           | V-ns |
| Maximum peak amplitude allowed for overshoot  | CK, /CK                      | 0.5           | V    |
| Maximum peak amplitude allowed for undershoot |                              | 0.5           | V    |
| Maximum overshoot area above VDD              |                              | 0.23          | V-ns |
| Maximum undershoot area below VSS             |                              | 0.23          | V-ns |
| Maximum peak amplitude allowed for overshoot  | DQ, DQS, /DQS,               | 0.5           | V    |
| Maximum peak amplitude allowed for undershoot | UDQS, /UDQS,<br>LDQS, /LDQS, | 0.5           | V    |
| Maximum overshoot area above VDDQ             | RDQS, /RDQS,<br>DM, UDM, LDM | 0.23          | V-ns |
| Maximum undershoot area below VSSQ            |                              | 0.23          | V-ns |

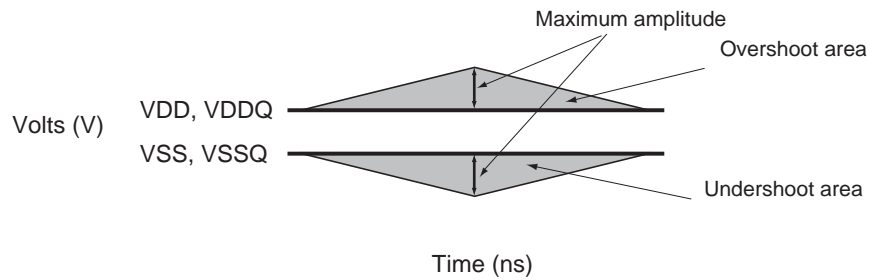

**Overshoot/Undershoot Definition**

DC Characteristics 1 (TC = 0°C to +85°C, VDD = 1.8V ± 0.1V, VSS = 0V)

| Parameter  | Symbol  | Grade           | max.         | Unit | Test condition  |                              |
|--|---------|-----------------|--------------|------|---|------------------------------|
| Operating current<br>(ACT-PRE)<br>(Another rank is in IDD2P)               | IDD0    | -8E, -8G<br>-6E | 855<br>810   | mA   | one bank; tCK = tCK (IDD), tRC = tRC (IDD),<br>tRAS = tRAS min.(IDD);<br>CKE is H, /CS is H between valid commands;   |                              |
| Operating current<br>(ACT-PRE)<br>(Another rank is in IDD3N)               | IDD0    | -8E, -8G<br>-6E | 1575<br>1440 | mA   | Address bus inputs are SWITCHING;<br>Data bus inputs are SWITCHING  |                              |
| Operating current<br>(ACT-READ-PRE)<br>(Another rank is in IDD2P)          | IDD1    | -8E, -8G<br>-6E | 990<br>945   | mA   | one bank; IOUT = 0mA;<br>BL = 4, CL = CL(IDD), AL = 0;<br>tCK = tCK (IDD), tRC = tRC (IDD),<br>tRAS = tRAS min.(IDD); tRCD = tRCD (IDD);  |                              |
| Operating current<br>(ACT-READ-PRE)<br>(Another rank is in IDD3N)          | IDD1    | -8E, -8G<br>-6E | 1710<br>1575 | mA   | CKE is H, /CS is H between valid commands;<br>Address bus inputs are SWITCHING;<br>Data pattern is same as IDD4W  |                              |
| Precharge power-down<br>standby current                                    | IDD2P   |                 | 180          | mA   | all banks idle;<br>tCK = tCK (IDD);<br>CKE is L;<br>Other control and address bus inputs are STABLE;<br>Data bus inputs are FLOATING  |                              |
| Precharge quiet standby<br>current   | IDD2Q   | -8E, -8G<br>-6E | 630<br>540   | mA   | all banks idle;<br>tCK = tCK (IDD);<br>CKE is H, /CS is H;<br>Other control and address bus inputs are STABLE;<br>Data bus inputs are FLOATING  |                              |
| Idle standby current   | IDD2N   | -8E, -8G<br>-6E | 720<br>630   | mA   | all banks idle;<br>tCK = tCK (IDD);<br>CKE is H, /CS is H;<br>Other control and address bus inputs are SWITCHING;<br>Data bus inputs are SWITCHING  |                              |
| Active power-down<br>standby current                                       | IDD3P-F | -8E, -8G<br>-6E | 630          | mA   | all banks open;<br>tCK = tCK (IDD);<br>CKE is L;<br>Other control and address bus<br>inputs are STABLE;   | Fast PDN Exit<br>MRS(12) = 0 |
|  | IDD3P-S |                 | 360          | mA   | Data bus inputs are FLOATING  | Slow PDN Exit<br>MRS(12) = 1 |
| Active standby current   | IDD3N   | -8E, -8G<br>-6E | 1620<br>1440 | mA   | all banks open;<br>tCK = tCK (IDD), tRAS = tRAS max.(IDD), tRP = tRP (IDD);<br>CKE is H, /CS is H between valid commands;<br>Other control and address bus inputs are SWITCHING;<br>Data bus inputs are SWITCHING |                              |
| Operating current<br>(Burst read operating)<br>(Another rank is in IDD2P)  | IDD4R   | -8E, -8G<br>-6E | 1530<br>1350 | mA   | all banks open, continuous burst reads, IOUT = 0mA;<br>BL = 4, CL = CL(IDD), AL = 0;<br>tCK = tCK (IDD), tRAS = tRAS max.(IDD), tRP = tRP (IDD);  |                              |
| Operating current<br>(Burst read operating)<br>(Another rank is in IDD3N)  | IDD4R   | -8E, -8G<br>-6E | 2250<br>1980 | mA   | CKE is H, /CS is H between valid commands;<br>Address bus inputs are SWITCHING;<br>Data pattern is same as IDD4W  |                              |
| Operating current<br>(Burst write operating)<br>(Another rank is in IDD2P) | IDD4W   | -8E, -8G<br>-6E | 1530<br>1350 | mA   | all banks open, continuous burst writes;<br>BL = 4, CL = CL(IDD), AL = 0;<br>tCK = tCK (IDD), tRAS = tRAS max.(IDD), tRP = tRP (IDD);   |                              |
| Operating current<br>(Burst write operating)<br>(Another rank is in IDD3N) | IDD4W   | -8E, -8G<br>-6E | 2250<br>1980 | mA   | CKE is H, /CS is H between valid commands;<br>Address bus inputs are SWITCHING;<br>Data bus inputs are SWITCHING  |                              |

| Parameter  | Symbol | Grade           | max.         | Unit | Test condition  |
|--|--------|-----------------|--------------|------|---|
| Auto-refresh current<br>(Another rank is in IDD2P)                     | IDD5   | -8E, -8G<br>-6E | 2700<br>2610 | mA   | tCK = tCK (IDD);<br>Refresh command at every tRFC (IDD) interval;<br>CKE is H, /CS is H between valid commands;<br>Other control and address bus inputs are SWITCHING;<br>Data bus inputs are SWITCHING           |
| Auto-refresh current<br>(Another rank is in IDD3N)                     | IDD5   | -8E, -8G<br>-6E | 3420<br>3240 | mA   |   |
| Self-refresh current   | IDD6   |                 | 180          | mA   | Self Refresh Mode;<br>CK and /CK at 0V;<br>CKE ≤ 0.2V;<br>Other control and address bus inputs are FLOATING;<br>Data bus inputs are FLOATING  |
| Operating current<br>(Bank interleaving)<br>(Another rank is in IDD2P) | IDD7   | -8E, -8G<br>-6E | 2700<br>2565 | mA   | all bank interleaving reads, IOU <sub>T</sub> = 0mA;<br>BL = 4, CL = CL(IDD), AL = tRCD (IDD) - 1 × tCK (IDD);<br>tCK = tCK (IDD), tRC = tRC (IDD), tRRD = tRRD(IDD),<br>tFAW = tFAW (IDD), tRCD = 1 × tCK (IDD); |
| Operating current<br>(Bank interleaving)<br>(Another rank is in IDD3N) | IDD7   | -8E, -8G<br>-6E | 3420<br>3195 | mA   | CKE is H, /CS is H between valid commands;<br>Address bus inputs are STABLE during DESELECTs;<br>Data pattern is same as IDD4W;   |

- Notes:
1. IDD specifications are tested after the device is properly initialized.
  2. Input slew rate is specified by AC Input Test Condition.
  3. IDD parameters are specified with ODT disabled.
  4. Data bus consists of DQ, DM, DQS, /DQS, RDQS and /RDQS. IDD values must be met with all combinations of EMRS bits 10 and 11.
  5. Definitions for IDD  
L is defined as  $V_{IN} \leq V_{IL} (AC) (max.)$   
H is defined as  $V_{IN} \geq V_{IH} (AC) (min.)$   
STABLE is defined as inputs stable at an H or L level  
FLOATING is defined as inputs at  $V_{REF} = V_{DDQ}/2$   
SWITCHING is defined as:  
inputs changing between H and L every other clock cycle (once per two clocks) for address and control signals, and inputs changing between H and L every other data transfer (once per clock) for DQ signals not including masks or strobes.
  6. Refer to AC Timing for IDD Test Conditions.

**AC Timing for IDD Test Conditions**

For purposes of IDD testing, the following parameters are to be utilized.

| Parameter        | DDR2-800 | DDR2-800 | DDR2-667 | Unit |
|------------------|----------|----------|----------|------|
|                  | 5-5-5    | 6-6-6    | 5-5-5    |      |
| CL (IDD)         | 5        | 6        | 5        | tCK  |
| tRCD (IDD)       | 12.5     | 15       | 15       | ns   |
| tRC (IDD)        | 57.5     | 60       | 60       | ns   |
| tRRD (IDD)       | 7.5      | 7.5      | 7.5      | ns   |
| tFAW (IDD)       | 35       | 35       | 37.5     | ns   |
| tCK (IDD)        | 2.5      | 2.5      | 3        | ns   |
| tRAS (min.)(IDD) | 45       | 45       | 45       | ns   |
| tRAS (max.)(IDD) | 70000    | 70000    | 70000    | ns   |
| tRP (IDD)        | 12.5     | 15       | 15       | ns   |
| tRFC (IDD)       | 127.5    | 127.5    | 127.5    | ns   |

**DC Characteristics 2 (TC = 0°C to +85°C, VDD, VDDQ = 1.8V ± 0.1V)**

**(DDR2 SDRAM Component Specification)**

| Parameter  | Symbol | Value       | Unit | Notes             |
|--|--------|-------------|------|-------------------|
| Input leakage current                                | ILI    | 2           | μA   | VDD ≥ VIN ≥ VSS   |
| Output leakage current                               | ILO    | 5           | μA   | VDDQ ≥ VOUT ≥ VSS |
| Minimum required output pull-up under AC test load   | VOH    | VTT + 0.603 | V    | 5                 |
| Maximum required output pull-down under AC test load | VOL    | VTT - 0.603 | V    | 5                 |
| Output timing measurement reference level            | VOTR   | 0.5 × VDDQ  | V    | 1                 |
| Output minimum sink DC current                       | IOL    | +13.4       | mA   | 3, 4, 5           |
| Output minimum source DC current                     | IOH    | -13.4       | mA   | 2, 4, 5           |

- Notes: 1. The VDDQ of the device under test is referenced.  
 2. VDDQ = 1.7V; VOUT = 1.42V.  
 3. VDDQ = 1.7V; VOUT = 0.28V.  
 4. The DC value of VREF applied to the receiving device is expected to be set to VTT.  
 5. After OCD calibration to 18Ω at TC = 25°C, VDD = VDDQ = 1.8V.

**DC Characteristics 3 (TC = 0°C to +85°C, VDD, VDDQ = 1.8V ± 0.1V)**

**(DDR2 SDRAM Component Specification)**

| Parameter                           | Symbol   | min.               | max.               | Unit | Notes |
|-------------------------------------|----------|--------------------|--------------------|------|-------|
| AC differential input voltage       | VID (AC) | 0.5                | VDDQ + 0.6         | V    | 1, 2  |
| AC differential cross point voltage | VIX (AC) | 0.5 × VDDQ - 0.175 | 0.5 × VDDQ + 0.175 | V    | 2     |
| AC differential cross point voltage | VOX (AC) | 0.5 × VDDQ - 0.125 | 0.5 × VDDQ + 0.125 | V    | 3     |

- Notes: 1. VID (AC) specifies the input differential voltage [VTR -VCP] required for switching, where VTR is the true input signal (such as CK, DQS, RDQS) and VCP is the complementary input signal (such as /CK, /DQS, /RDQS). The minimum value is equal to VIH (AC) - VIL (AC).  
 2. The typical value of VIX (AC) is expected to be about 0.5 × VDDQ of the transmitting device and VIX (AC) is expected to track variations in VDDQ. VIX (AC) indicates the voltage at which differential input signals must cross.  
 3. The typical value of VOX (AC) is expected to be about 0.5 × VDDQ of the transmitting device and VOX (AC) is expected to track variations in VDDQ. VOX (AC) indicates the voltage at which differential output signals must cross.

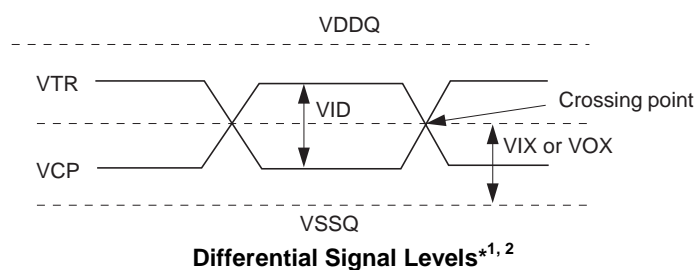

**ODT DC Electrical Characteristics (TC = 0°C to +85°C, VDD, VDDQ = 1.8V ± 0.1V)**

**(DDR2 SDRAM Component Specification)**

| Parameter   | Symbol    | min. | typ. | max. | Unit | Note |
|---|-----------|------|------|------|------|------|
| Rtt effective impedance value for EMRS (A6, A2) = 0, 1; 75 Ω  | Rtt1(eff) | 60   | 75   | 90   | Ω    | 1    |
| Rtt effective impedance value for EMRS (A6, A2) = 1, 0; 150 Ω | Rtt2(eff) | 120  | 150  | 180  | Ω    | 1    |
| Rtt effective impedance value for EMRS (A6, A2) = 1, 1; 50 Ω  | Rtt3(eff) | 40   | 50   | 60   | Ω    | 1    |
| Deviation of VM with respect to VDDQ/2                        | ΔVM       | -6   | —    | +6   | %    | 1    |

Note: 1. Test condition for Rtt measurements.

**Measurement Definition for Rtt (eff)**

Apply VIH (AC) and VIL (AC) to test pin separately, then measure current I(VIH (AC)) and I(VIL (AC)) respectively. VIH (AC), and VDDQ values defined in SSTL\_18.

$$R_{tt}(eff) = \frac{V_{IH}(AC) - V_{IL}(AC)}{I(V_{IH}(AC)) - I(V_{IL}(AC))}$$

**Measurement Definition for ΔVM**

Measure voltage (VM) at test pin (midpoint) with no load.

$$\Delta VM = \left( \frac{2 \times VM}{VDDQ} - 1 \right) \times 100$$

**OCD Default Characteristics (TC = 0°C to +85°C, VDD, VDDQ = 1.8V ± 0.1V)**

**(DDR2 SDRAM Component Specification)**

| Parameter                      | min. | typ. | max. | Unit | Notes |
|--------------------------------|------|------|------|------|-------|
| Output impedance               | 12.6 | 18   | 23.4 | Ω    | 1, 5  |
| Pull-up and pull-down mismatch | 0    | —    | 4    | Ω    | 1, 2  |
| Output slew rate               | 1.5  | —    | 5    | V/ns | 3, 4  |

Notes: 1. Impedance measurement condition for output source DC current: VDDQ = 1.7V; VOUT = 1420mV; (VOUT-VDDQ)/IOH must be less than 23.4Ω for values of VOUT between VDDQ and VDDQ-280mV. Impedance measurement condition for output sink DC current: VDDQ = 1.7V; VOUT = 280mV; VOUT/IOH must be less than 23.4Ω for values of VOUT between 0V and 280mV.

- Mismatch is absolute value between pull up and pull down, both are measured at same temperature and voltage.
- Slew rate measured from VIL(AC) to VIH(AC).
- The absolute value of the slew rate as measured from DC to DC is equal to or greater than the slew rate as measured from AC to AC. This is guaranteed by design and characterization.
- DRAM I/O specifications for timing, voltage, and slew rate are no longer applicable if OCD is changed from default settings.



**Pin Capacitance (TA = 25°C, VDD = 1.8V ± 0.1V)**

**(DDR2 SDRAM Component Specification)**

| Parameter                       | Symbol | Pins  | min. | max. | Unit | Notes |
|---------------------------------|--------|---|------|------|------|-------|
| CLK input pin capacitance       | CCK    | CK, /CK   | 1.0  | 2.0  | pF   | 1     |
| Input capacitance<br>-8E, -8G   | CIN    | /RAS, /CAS,<br>/WE, /CS,  | 1.0  | 1.75 | pF   | 1     |
|                                 |        | CKE, ODT,<br>Address  | 1.0  | 2.0  | pF   | 1     |
| Input/output pin<br>capacitance | CI/O   | DQ, DQS, /DQS, UDQS,<br>/UDQS,<br>LDQS, /LDQS, RDQS,<br>/RDQS, DM, UDM, LDM, CB | 2.5  | 3.5  | pF   | 2     |

- Notes: 1. Matching within 0.25pF.  
 2. Matching within 0.50pF.

**AC Characteristics (TC = 0°C to +85°C, VDD, VDDQ = 1.8V ± 0.1V, VSS, VSSQ = 0V)**

**(DDR2 SDRAM Component Specification)**

- New units tCK(avg) and nCK, are introduced in DDR2-800 and DDR2-667  
tCK(avg): actual tCK(avg) of the input clock under operation.  
nCK: one clock cycle of the input clock, counting the actual clock edges.

| Speed bin | Parameter   | Symbol     | -8E                       |          | -8G                       |          | -6E                       |          | Unit      | Notes |
|-----------|---|------------|---------------------------|----------|---------------------------|----------|---------------------------|----------|-----------|-------|
|           |   |            | DDR2-800 (5-5-5)          |          | DDR2-800 (6-6-6)          |          | DDR2-667 (5-5-5)          |          |           |       |
|           |   |            | min.                      | max.     | min.                      | max.     | min.                      | max.     |           |       |
|           | Active to read or write command delay                     | tRCD       | 12.5                      | —        | 15                        | —        | 15                        | —        | ns        |       |
|           | Precharge command period                                  | tRP        | 12.5                      | —        | 15                        | —        | 15                        | —        | ns        |       |
|           | Active to active/auto-refresh command time                | tRC        | 57.5                      | —        | 60                        | —        | 60                        | —        | ns        |       |
|           | DQ output access time from CK, /CK                        | tAC        | -400                      | +400     | -400                      | +400     | -450                      | +450     | ps        | 10    |
|           | DQS output access time from CK, /CK                       | tDQSCK     | -350                      | +350     | -350                      | +350     | -400                      | +400     | ps        | 10    |
|           | CK high-level width                                       | tCH (avg)  | 0.48                      | 0.52     | 0.48                      | 0.52     | 0.48                      | 0.52     | tCK (avg) | 13    |
|           | CK low-level width  | tCL(avg)   | 0.48                      | 0.52     | 0.48                      | 0.52     | 0.48                      | 0.52     | tCK (avg) | 13    |
|           | CK half period  | tHP        | Min. (tCL(abs), tCH(abs)) | —        | Min. (tCL(abs), tCH(abs)) | —        | Min. (tCL(abs), tCH(abs)) | —        | ps        | 6, 13 |
|           | Clock cycle time (CL = 6)                                 | tCK (avg)  | 2500                      | 8000     | 2500                      | 8000     | 3000                      | 8000     | ps        | 13    |
|           | (CL = 5)  | tCK (avg)  | 2500                      | 8000     | 3000                      | 8000     | 3000                      | 8000     | ps        | 13    |
|           | (CL = 4)  | tCK (avg)  | 3750                      | 8000     | 3750                      | 8000     | 3750                      | 8000     | ps        | 13    |
|           | (CL = 3)  | tCK (avg)  | 5000                      | 8000     | 5000                      | 8000     | 5000                      | 8000     | ps        | 13    |
|           | DQ and DM input hold time                                 | tDH (base) | 125                       | —        | 125                       | —        | 175                       | —        | ps        | 5     |
|           | DQ and DM input setup time                                | tDS (base) | 50                        | —        | 50                        | —        | 100                       | —        | ps        | 4     |
|           | Control and Address input pulse width for each input      | tIPW       | 0.6                       | —        | 0.6                       | —        | 0.6                       | —        | tCK (avg) |       |
|           | DQ and DM input pulse width for each input                | tDIPW      | 0.35                      | —        | 0.35                      | —        | 0.35                      | —        | tCK (avg) |       |
|           | Data-out high-impedance time from CK,/CK                  | tHZ        | —                         | tAC max. | —                         | tAC max. | —                         | tAC max. | ps        | 10    |
|           | DQS, /DQS low-impedance time from CK,/CK                  | tLZ (DQS)  | tAC min.                  | tAC max. | tAC min.                  | tAC max. | tAC min.                  | tAC max. | ps        | 10    |
|           | DQ low-impedance time from CK,/CK                         | tLZ (DQ)   | 2 × tAC min.              | tAC max. | 2 × tAC min.              | tAC max. | 2 × tAC min.              | tAC max. | ps        | 10    |
|           | DQS-DQ skew for DQS and associated DQ signals             | tDQSQ      | —                         | 200      | —                         | 200      | —                         | 240      | ps        |       |
|           | DQ hold skew factor                                       | tQHS       | —                         | 300      | —                         | 300      | —                         | 340      | ps        | 7     |
|           | DQ/DQS output hold time from DQS                          | tQH        | tHP – tQHS                | —        | tHP – tQHS                | —        | tHP – tQHS                | —        | ps        | 8     |
|           | DQS latching rising transitions to associated clock edges | tDQSS      | -0.25                     | +0.25    | -0.25                     | +0.25    | -0.25                     | +0.25    | tCK (avg) |       |
|           | DQS input high pulse width                                | tDQSH      | 0.35                      | —        | 0.35                      | —        | 0.35                      | —        | tCK (avg) |       |
|           | DQS input low pulse width                                 | tDQSL      | 0.35                      | —        | 0.35                      | —        | 0.35                      | —        | tCK (avg) |       |
|           | DQS falling edge to CK setup time                         | tDSS       | 0.2                       | —        | 0.2                       | —        | 0.2                       | —        | tCK (avg) |       |

| Speed bin | Parameter   | Symbol     | -8E                      |       | -8G                      |       | -6E                      |       | Unit      | Notes |
|-----------|---|------------|--------------------------|-------|--------------------------|-------|--------------------------|-------|-----------|-------|
|           |   |            | DDR2-800 (5-5-5)         |       | DDR2-800 (6-6-6)         |       | DDR2-667 (5-5-5)         |       |           |       |
|           |   |            | min.                     | max.  | min.                     | max.  | min.                     | max.  |           |       |
|           | DQS falling edge hold time from CK                                | tDSH       | 0.2                      | —     | 0.2                      | —     | 0.2                      | —     | tCK (avg) |       |
|           | Mode register set command cycle time                              | tMRD       | 2                        | —     | 2                        | —     | 2                        | —     | nCK       |       |
|           | Write postamble   | tWPST      | 0.4                      | 0.6   | 0.4                      | 0.6   | 0.4                      | 0.6   | tCK (avg) |       |
|           | Write preamble  | tWPRE      | 0.35                     | —     | 0.35                     | —     | 0.35                     | —     | tCK (avg) |       |
|           | Address and control input hold time                               | tIH (base) | 250                      | —     | 250                      | —     | 275                      | —     | ps        | 5     |
|           | Address and control input setup time                              | tIS (base) | 175                      | —     | 175                      | —     | 200                      | —     | ps        | 4     |
|           | Read preamble   | tRPRE      | 0.9                      | 1.1   | 0.9                      | 1.1   | 0.9                      | 1.1   | tCK (avg) | 11    |
|           | Read postamble  | tRPST      | 0.4                      | 0.6   | 0.4                      | 0.6   | 0.4                      | 0.6   | tCK (avg) | 12    |
|           | Active to precharge command                                       | tRAS       | 45                       | 70000 | 45                       | 70000 | 45                       | 70000 | ns        |       |
|           | Active to auto-precharge delay                                    | tRAP       | tRCD min.                | —     | tRCD min.                | —     | tRCD min.                | —     | ns        |       |
|           | Active bank A to active bank B command period                     | tRRD       | 7.5                      | —     | 7.5                      | —     | 7.5                      | —     | ns        |       |
|           | Four active window period   | tFAW       | 35                       | —     | 35                       | —     | 37.5                     | —     | ns        |       |
|           | /CAS to /CAS command delay  | tCCD       | 2                        | —     | 2                        | —     | 2                        | —     | nCK       |       |
|           | Write recovery time   | tWR        | 15                       | —     | 15                       | —     | 15                       | —     | ns        |       |
|           | Auto precharge write recovery + precharge time                    | tDAL       | WR + RU (tRP/ tCK (avg)) | —     | WR + RU (tRP/ tCK (avg)) | —     | WR + RU (tRP/ tCK (avg)) | —     | nCK       | 1, 9  |
|           | Internal write to read command delay                              | tWTR       | 7.5                      | —     | 7.5                      | —     | 7.5                      | —     | ns        |       |
|           | Internal read to precharge command delay                          | tRTP       | 7.5                      | —     | 7.5                      | —     | 7.5                      | —     | ns        |       |
|           | Exit self-refresh to a non-read command                           | tXSNR      | tRFC + 10                | —     | tRFC + 10                | —     | tRFC + 10                | —     | ns        |       |
|           | Exit self-refresh to a read command                               | tXSRD      | 200                      | —     | 200                      | —     | 200                      | —     | nCK       |       |
|           | Exit precharge power down to any non-read command                 | tXP        | 2                        | —     | 2                        | —     | 2                        | —     | nCK       |       |
|           | Exit active power down to read command                            | tXARD      | 2                        | —     | 2                        | —     | 2                        | —     | nCK       | 3     |
|           | Exit active power down to read command (slow exit/low power mode) | tXARDS     | 8 – AL                   | —     | 8 – AL                   | —     | 7 – AL                   | —     | nCK       | 2, 3  |
|           | CKE minimum pulse width (high and low pulse width)                | tCKE       | 3                        | —     | 3                        | —     | 3                        | —     | nCK       |       |
|           | Output impedance test driver delay                                | tOIT       | 0                        | 12    | 0                        | 12    | 0                        | 12    | ns        |       |
|           | MRS command to ODT update delay                                   | tMOD       | 0                        | 12    | 0                        | 12    | 0                        | 12    | ns        |       |
|           | Auto-refresh to active/auto-refresh command time                  | tRFC       | 127.5                    | —     | 127.5                    | —     | 127.5                    | —     | ns        |       |
|           | Average periodic refresh interval (0°C ≤ TC ≤ +85°C)              | tREFI      | —                        | 7.8   | —                        | 7.8   | —                        | 7.8   | μs        |       |
|           | (+85°C < TC ≤ +95°C)  | tREFI      | —                        | 3.9   | —                        | 3.9   | —                        | 3.9   | μs        |       |
|           | Minimum time clocks remains ON after CKE asynchronously drops low | tDELAY     | tIS + tCK(avg) + tIH     | —     | tIS + tCK(avg) + tIH     | —     | tIS + tCK(avg) + tIH     | —     | ns        |       |

- Notes: 1. For each of the terms above, if not already an integer, round to the next higher integer.  
 2. AL: Additive Latency.  
 3. MRS A12 bit defines which active power down exit timing to be applied.  
 4. The figures of Input Waveform Timing 1 and 2 are referenced from the input signal crossing at the VIH(AC) level for a rising signal and VIL(AC) for a falling signal applied to the device under test.  
 5. The figures of Input Waveform Timing 1 and 2 are referenced from the input signal crossing at the VIL(DC) level for a rising signal and VIH(DC) for a falling signal applied to the device under test.

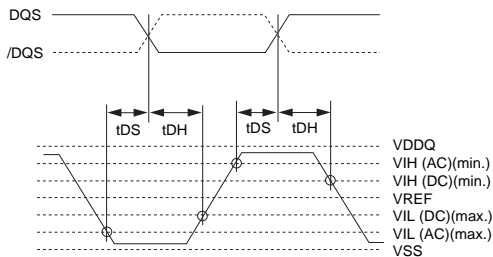

Input Waveform Timing 1 (tDS, tDH)

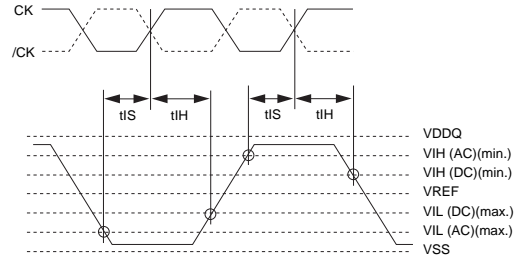

Input Waveform Timing 2 (tIS, tIH)

6. tHP is the minimum of the absolute half period of the actual input clock. tHP is an input parameter but not an input specification parameter. It is used in conjunction with tQHS to derive the DRAM output timing tQH.

The value to be used for tQH calculation is determined by the following equation;

$$tHP = \min ( tCH(abs), tCL(abs) ),$$

where,

tCH(abs) is the minimum of the actual instantaneous clock high time;

tCL(abs) is the minimum of the actual instantaneous clock low time;

7. tQHS accounts for:  
 a. The pulse duration distortion of on-chip clock circuits, which represents how well the actual tHP at the input is transferred to the output; and  
 b. The worst case push-out of DQS on one transition followed by the worst case pull-in of DQ on the next transition, both of which are independent of each other, due to data pin skew, output pattern effects, and p-channel to n-channel variation of the output drivers.

8. tQH = tHP – tQHS, where:

tHP is the minimum of the absolute half period of the actual input clock; and tQHS is the specification value under the max column.

{The less half-pulse width distortion present, the larger the tQH value is; and the larger the valid data eye will be.}

Examples:

- a. If the system provides tHP of 1315ps into a DDR2-667 SDRAM, the DRAM provides tQH of 975ps (min.)  
 b. If the system provides tHP of 1420ps into a DDR2-667 SDRAM, the DRAM provides tQH of 1080ps (min.)

9. RU stands for round up. WR refers to the tWR parameter stored in the MRS.

10. When the device is operated with input clock jitter, this parameter needs to be derated by the actual tERR(6-10per) of the input clock. (output deratings are relative to the SDRAM input clock.)

For example, if the measured jitter into a DDR2-667 SDRAM has tERR(6-10per) min. = -272ps and tERR(6-10per) max. = +293ps, then tDQSCK min.(derated) = tDQSCK min. – tERR(6-10per) max. = -400ps – 293ps = -693ps and tDQSCK max.(derated) = tDQSCK max. – tERR(6-10per) min. = 400ps + 272ps = +672ps. Similarly, tLZ(DQ) for DDR2-667 derates to tLZ(DQ) min.(derated) = -900ps – 293ps = -1193ps and tLZ(DQ) max.(derated)= 450ps + 272ps = +722ps.

11. When the device is operated with input clock jitter, this parameter needs to be derated by the actual tJIT(per) of the input clock. (output deratings are relative to the SDRAM input clock.)

For example, if the measured jitter into a DDR2-667 SDRAM has tJIT(per) min. = -72ps and tJIT(per) max. = +93ps, then tRPRE min.(derated) = tRPRE min. + tJIT(per) min. = 0.9 × tCK(avg) – 72ps = +2178ps and tRPRE max.(derated) = tRPRE max. + tJIT(per) max. = 1.1 × tCK(avg) + 93ps = +2843ps.

12. When the device is operated with input clock jitter, this parameter needs to be derated by the actual tJIT(duty) of the input clock. (output deratings are relative to the SDRAM input clock.)

For example, if the measured jitter into a DDR2-667 SDRAM has tJIT(duty) min. = -72ps and tJIT(duty) max. = +93ps, then tRPST min.(derated) = tRPST min. + tJIT(duty) min. =  $0.4 \times tCK(\text{avg}) - 72\text{ps} = +928\text{ps}$  and tRPST max.(derated) = tRPST max. + tJIT(duty) max. =  $0.6 \times tCK(\text{avg}) + 93\text{ps} = +1592\text{ps}$ .

13. Refer to the Clock Jitter table.

**ODT AC Electrical Characteristics (DDR2 SDRAM Component Specification)**

| Parameter                       | Symbol | min.            | max.                     | Unit | Notes   |
|---------------------------------|--------|-----------------|--------------------------|------|---------|
| ODT turn-on delay               | tAOND  | 2               | 2                        | tCK  |         |
| ODT turn-on                     | tAON   | tAC (min)       | tAC (max) + 700          | ps   | 1, 3    |
| ODT turn-on (power down mode)   | tAONPD | tAC(min) + 2000 | 2tCK + tAC(max) + 1000   | ps   |         |
| ODT turn-off delay              | tAOFD  | 2.5             | 2.5                      | tCK  | 5       |
| ODT turn-off                    | tAOF   | tAC(min)        | tAC(max) + 600           | ps   | 2, 4, 5 |
| ODT turn-off (power down mode)  | tAOFPD | tAC(min) + 2000 | 2.5tCK + tAC(max) + 1000 | ps   |         |
| ODT to power down entry latency | tANPD  | 3               | 3                        | tCK  |         |
| ODT power down exit latency     | tAXPD  | 8               | 8                        | tCK  |         |

- Notes: 1. ODT turn on time min is when the device leaves high impedance and ODT resistance begins to turn on. ODT turn on time max is when the ODT resistance is fully on. Both are measured from tAOND.
2. ODT turn off time min is when the device starts to turn off ODT resistance. ODT turn off time max is when the bus is in high impedance. Both are measured from tAOFD.
3. When the device is operated with input clock jitter, this parameter needs to be derated by the actual tERR(6-10per) of the input clock. (output deratings are relative to the SDRAM input clock.)
4. When the device is operated with input clock jitter, this parameter needs to be derated by { -tJIT(duty) max. - tERR(6-10per) max. } and { -tJIT(duty) min. - tERR(6-10per) min. } of the actual input clock.(output deratings are relative to the SDRAM input clock.)  
 For example, if the measured jitter into a DDR2-667 SDRAM has tERR(6-10per) min. = -272ps, tERR(6-10per) max. = +293ps, tJIT(duty) min. = -106ps and tJIT(duty) max. = +94ps, then tAOF min.(derated) = tAOF min. + { -tJIT(duty) max. - tERR(6-10per) max. } = -450ps + { -94ps - 293ps } = -837ps and tAOF max.(derated) = tAOF max. + { -tJIT(duty) min. - tERR(6-10per) min. } = 1050ps + { 106ps + 272ps } = +1428ps.
5. For tAOFD of DDR2-667/800, the 1/2 clock of nCK in the 2.5 × nCK assumes a tCH(avg), average input clock high pulse width of 0.5 relative to tCK(avg). tAOF min. and tAOF max. should each be derated by the same amount as the actual amount of tCH(avg) offset present at the DRAM input with respect to 0.5. For example, if an input clock has a worst case tCH(avg) of 0.48, the tAOF min. should be derated by subtracting 0.02 × tCK(avg) from it, whereas if an input clock has a worst case tCH(avg) of 0.52, the tAOF max. should be derated by adding 0.02 × tCK(avg) to it. Therefore, we have;
- $$tAOF \text{ min. (derated) } = tAC \text{ min.} - [0.5 - \text{Min.}(0.5, tCH(\text{avg}) \text{ min.})] \times tCK(\text{avg})$$
- $$tAOF \text{ max. (derated) } = tAC \text{ max.} + 0.6 + [\text{Max.}(0.5, tCH(\text{avg}) \text{ max.}) - 0.5] \times tCK(\text{avg})$$
- or
- $$tAOF \text{ min. (derated) } = \text{Min.}(tAC \text{ min.}, tAC \text{ min.} - [0.5 - tCH(\text{avg}) \text{ min.}] \times tCK(\text{avg}))$$
- $$tAOF \text{ max. (derated) } = 0.6 + \text{Max.}(tAC \text{ max.}, tAC \text{ max.} + [tCH(\text{avg}) \text{ max.} - 0.5] \times tCK(\text{avg}))$$
- where tCH(avg) min. and tCH(avg) max. are the minimum and maximum of tCH(avg) actually measured at the DRAM input balls.

**AC Input Test Conditions (DDR2 SDRAM Component Specification)**

| Parameter                               | Symbol        | Value             | Unit | Notes |
|---|---------------|-------------------|------|-------|
| Input reference voltage                 | VREF          | $0.5 \times VDDQ$ | V    | 1     |
| Input signal maximum peak to peak swing | VSWING (max.) | 1.0               | V    | 1     |
| Input signal minimum slew rate          | SLEW          | 1.0               | V/ns | 2, 3  |

- Notes: 1. Input waveform timing is referenced to the input signal crossing through the VIH/IL (AC) level applied to the device under test.
2. The input signal minimum slew rate is to be maintained over the range from VREF to VIH (AC) (min.) for rising edges and the range from VREF to VIL (AC) (max.) for falling edges as shown in the below figure.
3. AC timings are referenced with input waveforms switching from VIL (AC) to VIH (AC) on the positive transitions and VIH (AC) to VIL (AC) on the negative transitions.

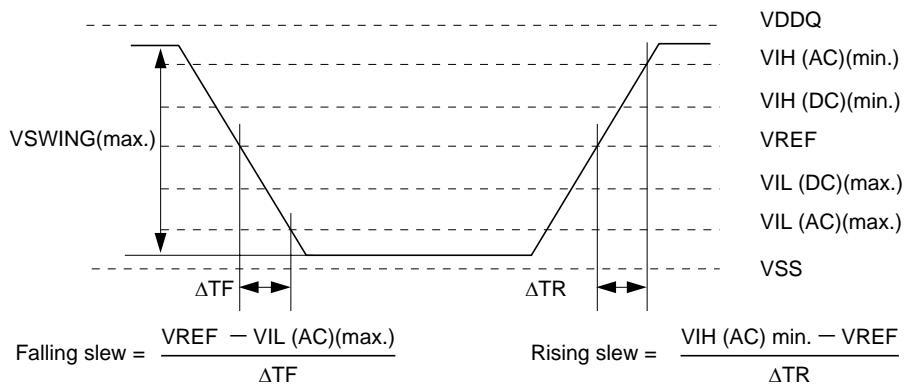

**AC Input Test Signal Wave forms**

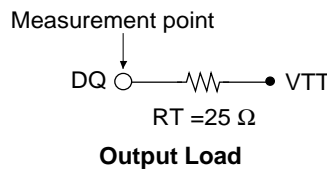

**Output Load**

**Clock Jitter [DDR2-800, 667]**

| Frequency (Mbps)   | Symbol          | -8E, -8G |      | -6E  |      | Unit      | Notes |
|--|-----------------|----------|------|------|------|-----------|-------|
|  |                 | 800      | 667  | 800  | 667  |           |       |
| Parameter  | Symbol          | min.     | max. | min. | max. | Unit      | Notes |
| Average clock period   | tCK (avg)       | 2500     | 8000 | 3000 | 8000 | ps        | 1     |
| Clock period jitter  | tJIT (per)      | -100     | 100  | -125 | 125  | ps        | 5     |
| Clock period jitter during DLL locking period                | tJIT (per, lck) | -80      | 80   | -100 | 100  | ps        | 5     |
| Cycle to cycle period jitter                                 | tJIT (cc)       | —        | 200  | —    | 250  | ps        | 6     |
| Cycle to cycle clock period jitter during DLL locking period | tJIT (cc, lck)  | —        | 160  | —    | 200  | ps        | 6     |
| Cumulative error across 2 cycles                             | tERR (2per)     | -150     | 150  | -175 | 175  | ps        | 7     |
| Cumulative error across 3 cycles                             | tERR (3per)     | -175     | 175  | -225 | 225  | ps        | 7     |
| Cumulative error across 4 cycles                             | tERR (4per)     | -200     | 200  | -250 | 250  | ps        | 7     |
| Cumulative error across 5 cycles                             | tERR (5per)     | -200     | 200  | -250 | 250  | ps        | 7     |
| Cumulative error across n=6,7,8,9,10 cycles                  | tERR (6-10per)  | -300     | 300  | -350 | 350  | ps        | 7     |
| Cumulative error across n=11, 12,...49,50 cycles             | tERR (11-50per) | -450     | 450  | -450 | 450  | ps        | 7     |
| Average high pulse width                                     | tCH (avg)       | 0.48     | 0.52 | 0.48 | 0.52 | tCK (avg) | 2     |
| Average low pulse width                                      | tCL (avg)       | 0.48     | 0.52 | 0.48 | 0.52 | tCK (avg) | 3     |
| Duty cycle jitter  | tJIT (duty)     | -100     | 100  | -125 | 125  | ps        | 4     |

Notes: 1. tCK (avg) is calculated as the average clock period across any consecutive 200cycle window.

$$tCK(avg) = \left\{ \sum_{j=1}^N tCK_j \right\} / N$$

N = 200

2. tCH (avg) is defined as the average high pulse width, as calculated across any consecutive 200 high pulses.

$$tCH(avg) = \left\{ \sum_{j=1}^N tCH_j \right\} / (N \times tCK(avg))$$

N = 200

3. tCL (avg) is defined as the average low pulse width, as calculated across any consecutive 200 low pulses.

$$tCL(avg) = \left\{ \sum_{j=1}^N tCL_j \right\} / (N \times tCK(avg))$$

N = 200

4. tJIT (duty) is defined as the cumulative set of tCH jitter and tCL jitter. tCH jitter is the largest deviation of any single tCH from tCH (avg). tCL jitter is the largest deviation of any single tCL from tCL (avg). tJIT (duty) is not subject to production test.

tJIT (duty) = Min./Max. of {tJIT (CH), tJIT (CL)}, where:

tJIT (CH) = {tCH<sub>j</sub> - tCH (avg) where j = 1 to 200}

tJIT (CL) = {tCL<sub>j</sub> - tCL (avg) where j = 1 to 200}

5. tJIT (per) is defined as the largest deviation of any single tCK from tCK (avg).

tJIT (per) = Min./Max. of {tCK<sub>j</sub> - tCK (avg) where j = 1 to 200}

tJIT (per) defines the single period jitter when the DLL is already locked. tJIT (per, lck) uses the same definition for single period jitter, during the DLL locking period only. tJIT (per) and tJIT (per, lck) are not subject to production test.



6. tJIT (cc) is defined as the absolute difference in clock period between two consecutive clock cycles:  
 $tJIT (cc) = \text{Max. of } |tCK_{j+1} - tCK_j|$   
 tJIT (cc) is defines the cycle to cycle jitter when the DLL is already locked. tJIT (cc, lck) uses the same definition for cycle to cycle jitter, during the DLL locking period only. tJIT (cc) and tJIT (cc, lck) are not subject to production test.
7. tERR (nper) is defined as the cumulative error across multiple consecutive cycles from tCK (avg).  
 tERR (nper) is not subject to production test.

$$tERR(nper) = \left\{ \sum_{j=1}^n tCK_j \right\} - n \times tCK(avg)$$

$2 \leq n \leq 50$  for tERR (nper)

8. These parameters are specified per their average values, however it is understood that the following relationship between the average timing and the absolute instantaneous timing hold at all times.  
 (minimum and maximum of spec values are to be used for calculations in the table below.)

| Parameter                       | Symbol    | min.   | max.   | Unit |
|---------------------------------|-----------|--|--|------|
| Absolute clock period           | tCK (abs) | tCK (avg) min. + tJIT (per) min.                   | tCK (avg) max. + tJIT (per) max.                   | ps   |
| Absolute clock high pulse width | tCH (abs) | tCH (avg) min. × tCK (avg) min. + tJIT (duty) min. | tCH (avg) max. × tCK (avg) max. + tJIT (duty) max. | ps   |
| Absolute clock low pulse width  | tCL (abs) | tCL (avg) min. × tCK (avg) min. + tJIT (duty) min. | tCL (avg) max. × tCK (avg) max. + tJIT (duty) max. | ps   |

Example: For DDR2-667, tCH(abs) min. = ( 0.48 × 3000 ps ) - 125ps = 1315ps

**Pin Functions**

**CK, /CK (input pin)**

The CK and the /CK are the master clock inputs. All inputs except DMs, DQSs and DQs are referred to the cross point of the CK rising edge and the VREF level. When a read operation, DQSs and DQs are referred to the cross point of the CK and the /CK. When a write operation, DMs and DQs are referred to the cross point of the DQS and the VREF level. DQSs for write operation are referred to the cross point of the CK and the /CK.

**/CS (input pin)**

When /CS is low, commands and data can be input. When /CS is high, all inputs are ignored. However, internal operations (bank active, burst operations, etc.) are held.

**/RAS, /CAS, and /WE (input pins)**

These pins define operating commands (read, write, etc.) depending on the combinations of their voltage levels. See "Command operation".

**A0 to A13 (input pins)**

Row address (AX0 to AX13) is determined by the A0 to the A13 level at the cross point of the CK rising edge and the VREF level in a bank active command cycle. Column address (AY0 to AY9) is loaded via the A0 to the A9 at the cross point of the CK rising edge and the VREF level in a read or a write command cycle. This column address becomes the starting address of a burst operation.

**A10 (AP) (input pin)**

A10 defines the precharge mode when a precharge command, a read command or a write command is issued. If A10 = high when a precharge command is issued, all banks are precharged. If A10 = low when a precharge command is issued, only the bank that is selected by BA1, BA0 is precharged. If A10 = high when read or write command, auto-precharge function is enabled. While A10 = low, auto-precharge function is disabled.

**BA0, BA1, BA2 (input pin)**

BA0, BA1 and BA2 are bank select signals (BA). The memory array is divided into 8 banks: bank 0 to bank 7. (See Bank Select Signal Table)

**[Bank Select Signal Table]**

|        | BA0 | BA1 | BA2 |
|--------|-----|-----|-----|
| Bank 0 | L   | L   | L   |
| Bank 1 | H   | L   | L   |
| Bank 2 | L   | H   | L   |
| Bank 3 | H   | H   | L   |
| Bank 4 | L   | L   | H   |
| Bank 5 | H   | L   | H   |
| Bank 6 | L   | H   | H   |
| Bank 7 | H   | H   | H   |

Remark: H: VIH. L: VIL.

**CKE (input pin)**

CKE controls power down and self-refresh. The power down and the self-refresh commands are entered when the CKE is driven low and exited when it resumes to high.

The CKE level must be kept for 1 CK cycle at least, that is, if CKE changes at the cross point of the CK rising edge and the VREF level with proper setup time t<sub>1S</sub>, at the next CK rising edge CKE level must be kept with proper hold time t<sub>1H</sub>.

**DQ and CB (input and output pins)**

Data are input to and output from these pins.

**DQS and /DQS (input and output pin)**

DQS and /DQS provide the read data strobes (as output) and the write data strobes (as input).

**DM (input pins)**

DM is the reference signal of the data input mask function. DMs are sampled at the cross point of DQS and /DQS.

**VDD (power supply pins)**

1.8V is applied. (VDD is for the internal circuit.)

**VDDSPD (power supply pin)**

1.8V is applied (For serial EEPROM).

**VSS (power supply pin)**

Ground is connected.

**Detailed Operation Part and Timing Waveforms**

Refer to the EDE1108ACBG, EDE1116ACBG datasheet (E1173E).

Physical Outline

Unit: mm

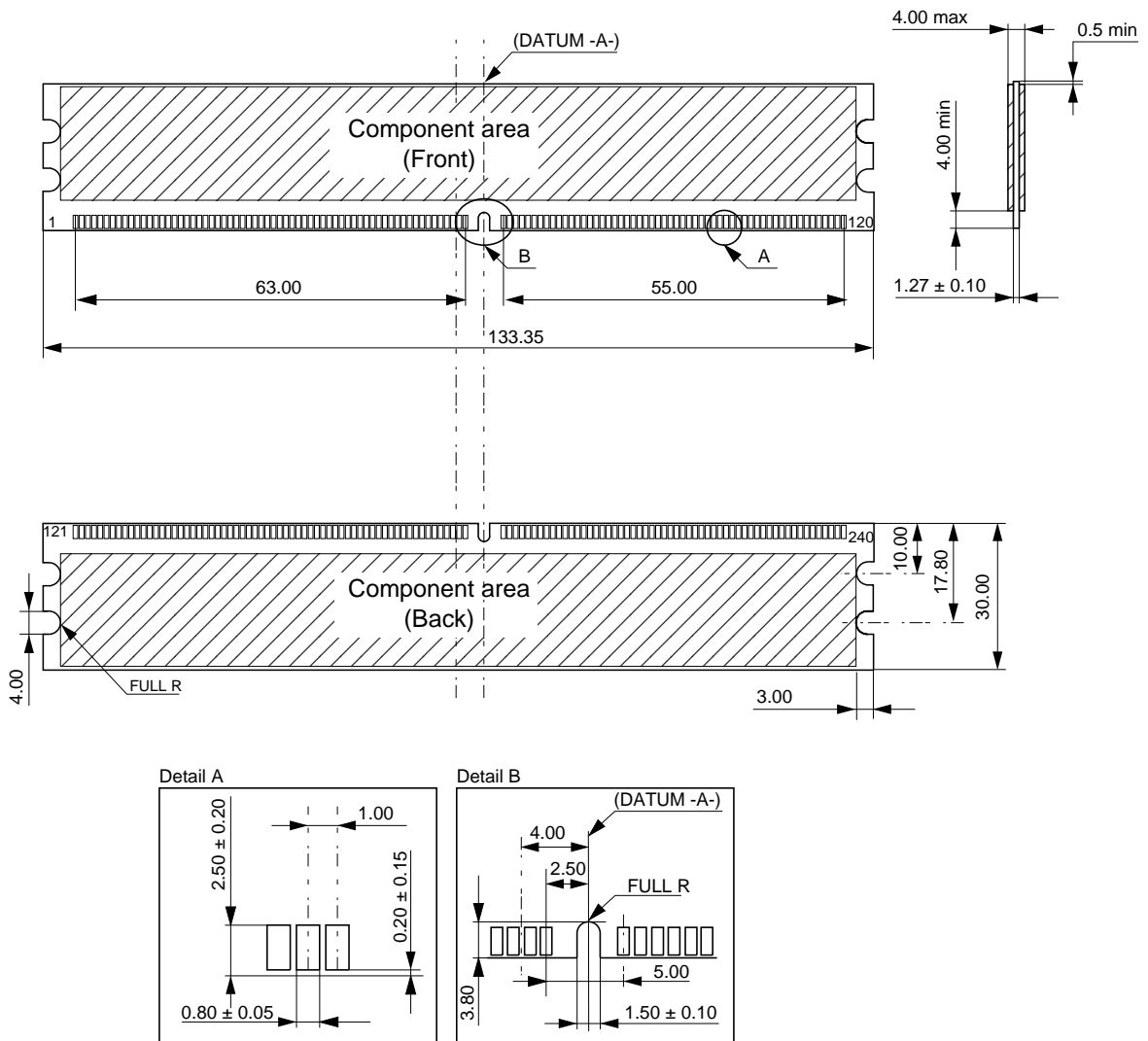

ECA-TS2-0093-01

**CAUTION FOR HANDLING MEMORY MODULES**

When handling or inserting memory modules, be sure not to touch any components on the modules, such as the memory ICs, chip capacitors and chip resistors. It is necessary to avoid undue mechanical stress on these components to prevent damaging them.

In particular, do not push module cover or drop the modules in order to protect from mechanical defects, which would be electrical defects.

When re-packing memory modules, be sure the modules are not touching each other.

Modules in contact with other modules may cause excessive mechanical stress, which may damage the modules.

MDE0202

**NOTES FOR CMOS DEVICES****① PRECAUTION AGAINST ESD FOR MOS DEVICES**

Exposing the MOS devices to a strong electric field can cause destruction of the gate oxide and ultimately degrade the MOS devices operation. Steps must be taken to stop generation of static electricity as much as possible, and quickly dissipate it, when once it has occurred. Environmental control must be adequate. When it is dry, humidifier should be used. It is recommended to avoid using insulators that easily build static electricity. MOS devices must be stored and transported in an anti-static container, static shielding bag or conductive material. All test and measurement tools including work bench and floor should be grounded. The operator should be grounded using wrist strap. MOS devices must not be touched with bare hands. Similar precautions need to be taken for PW boards with semiconductor MOS devices on it.

**② HANDLING OF UNUSED INPUT PINS FOR CMOS DEVICES**

No connection for CMOS devices input pins can be a cause of malfunction. If no connection is provided to the input pins, it is possible that an internal input level may be generated due to noise, etc., hence causing malfunction. CMOS devices behave differently than Bipolar or NMOS devices. Input levels of CMOS devices must be fixed high or low by using a pull-up or pull-down circuitry. Each unused pin should be connected to  $V_{DD}$  or GND with a resistor, if it is considered to have a possibility of being an output pin. The unused pins must be handled in accordance with the related specifications.

**③ STATUS BEFORE INITIALIZATION OF MOS DEVICES**

Power-on does not necessarily define initial status of MOS devices. Production process of MOS does not define the initial operation status of the device. Immediately after the power source is turned ON, the MOS devices with reset function have not yet been initialized. Hence, power-on does not guarantee output pin levels, I/O settings or contents of registers. MOS devices are not initialized until the reset signal is received. Reset operation must be executed immediately after power-on for MOS devices having reset function.

CME0107

The information in this document is subject to change without notice. Before using this document, confirm that this is the latest version.

No part of this document may be copied or reproduced in any form or by any means without the prior written consent of Elpida Memory, Inc.

Elpida Memory, Inc. does not assume any liability for infringement of any intellectual property rights (including but not limited to patents, copyrights, and circuit layout licenses) of Elpida Memory, Inc. or third parties by or arising from the use of the products or information listed in this document. No license, express, implied or otherwise, is granted under any patents, copyrights or other intellectual property rights of Elpida Memory, Inc. or others.

Descriptions of circuits, software and other related information in this document are provided for illustrative purposes in semiconductor product operation and application examples. The incorporation of these circuits, software and information in the design of the customer's equipment shall be done under the full responsibility of the customer. Elpida Memory, Inc. assumes no responsibility for any losses incurred by customers or third parties arising from the use of these circuits, software and information.

**[Product applications]**

Be aware that this product is for use in typical electronic equipment for general-purpose applications. Elpida Memory, Inc. makes every attempt to ensure that its products are of high quality and reliability. However, users are instructed to contact Elpida Memory's sales office before using the product in aerospace, aeronautics, nuclear power, combustion control, transportation, traffic, safety equipment, medical equipment for life support, or other such application in which especially high quality and reliability is demanded or where its failure or malfunction may directly threaten human life or cause risk of bodily injury.

**[Product usage]**

Design your application so that the product is used within the ranges and conditions guaranteed by Elpida Memory, Inc., including the maximum ratings, operating supply voltage range, heat radiation characteristics, installation conditions and other related characteristics. Elpida Memory, Inc. bears no responsibility for failure or damage when the product is used beyond the guaranteed ranges and conditions. Even within the guaranteed ranges and conditions, consider normally foreseeable failure rates or failure modes in semiconductor devices and employ systemic measures such as fail-safes, so that the equipment incorporating Elpida Memory, Inc. products does not cause bodily injury, fire or other consequential damage due to the operation of the Elpida Memory, Inc. product.

**[Usage environment]**

Usage in environments with special characteristics as listed below was not considered in the design. Accordingly, our company assumes no responsibility for loss of a customer or a third party when used in environments with the special characteristics listed below.

Example:

- 1) Usage in liquids, including water, oils, chemicals and organic solvents.
- 2) Usage in exposure to direct sunlight or the outdoors, or in dusty places.
- 3) Usage involving exposure to significant amounts of corrosive gas, including sea air, CL<sub>2</sub>, H<sub>2</sub>S, NH<sub>3</sub>, SO<sub>2</sub>, and NO<sub>x</sub>.
- 4) Usage in environments with static electricity, or strong electromagnetic waves or radiation.
- 5) Usage in places where dew forms.
- 6) Usage in environments with mechanical vibration, impact, or stress.
- 7) Usage near heating elements, igniters, or flammable items.

If you export the products or technology described in this document that are controlled by the Foreign Exchange and Foreign Trade Law of Japan, you must follow the necessary procedures in accordance with the relevant laws and regulations of Japan. Also, if you export products/technology controlled by U.S. export control regulations, or another country's export control laws or regulations, you must follow the necessary procedures in accordance with such laws or regulations.

If these products/technology are sold, leased, or transferred to a third party, or a third party is granted license to use these products, that third party must be made aware that they are responsible for compliance with the relevant laws and regulations.

M01E0706