

**Three level inverter
Trench + Field Stop IGBT
Power Module**

**$V_{CES} = 600V$
 $I_C = 50A @ T_c = 80^\circ C$**

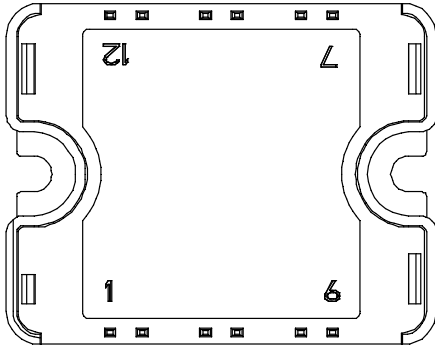
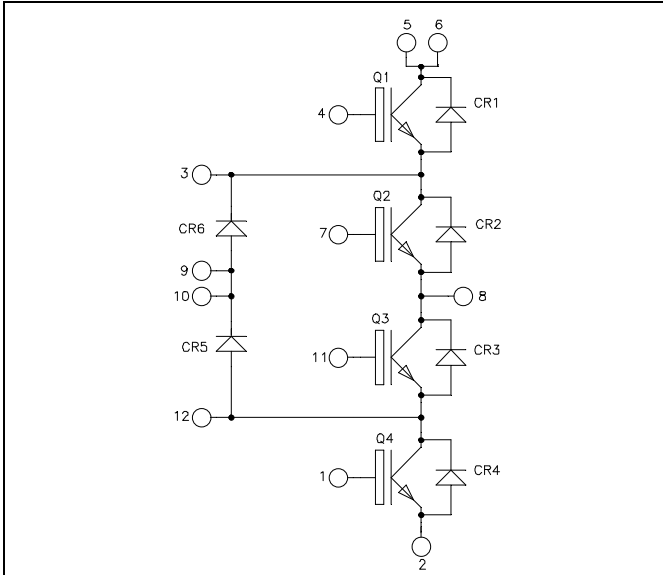

All multiple inputs and outputs must be shorted together
5/6 ; 9/10

Application

- Solar converter
- Uninterruptible Power Supplies

Features

- Trench + Field Stop IGBT Technology
 - Low voltage drop
 - Low tail current
 - Switching frequency up to 20 kHz
 - Soft recovery parallel diodes
 - Low diode VF
 - Low leakage current
 - RBSOA and SCSOA rated
- Very low stray inductance
- High level of integration

Benefits

- Stable temperature behavior
- Very rugged
- Direct mounting to heatsink (isolated package)
- Low junction to case thermal resistance
- Easy paralleling due to positive TC of VCEsat
- Low profile
- RoHS Compliant

Q1 to Q4 Absolute maximum ratings

Symbol	Parameter	Max ratings	Unit
V_{CES}	Collector - Emitter Breakdown Voltage	600	V
I_C	Continuous Collector Current	$T_C = 25^\circ C$	80
		$T_C = 80^\circ C$	50
I_{CM}	Pulsed Collector Current	$T_C = 25^\circ C$	100
V_{GE}	Gate - Emitter Voltage	± 20	V
P_D	Maximum Power Dissipation	$T_C = 25^\circ C$	176
RBSOA	Reverse Bias Safe Operating Area	$T_J = 150^\circ C$	100A @ 550V

CAUTION: These Devices are sensitive to Electrostatic Discharge. Proper Handling Procedures Should Be Followed.
See application note APT0502 on www.microsemi.com

All ratings @ $T_j = 25^\circ\text{C}$ unless otherwise specified

Q1 to Q4 Electrical Characteristics

Symbol	Characteristic	Test Conditions	Min	Typ	Max	Unit
I_{CES}	Zero Gate Voltage Collector Current	$V_{GE} = 0\text{V}, V_{CE} = 600\text{V}$			250	μA
$V_{CE(sat)}$	Collector Emitter Saturation Voltage	$V_{GE} = 15\text{V}$ $I_C = 50\text{A}$	$T_j = 25^\circ\text{C}$	1.5	1.9	V
			$T_j = 150^\circ\text{C}$	1.7		
$V_{GE(th)}$	Gate Threshold Voltage	$V_{GE} = V_{CE}, I_C = 600\mu\text{A}$	5.0	5.8	6.5	V
I_{GES}	Gate – Emitter Leakage Current	$V_{GE} = 20\text{V}, V_{CE} = 0\text{V}$			600	nA

Q1 to Q4 Dynamic Characteristics

Symbol	Characteristic	Test Conditions	Min	Typ	Max	Unit
C_{ies}	Input Capacitance	$V_{GE} = 0\text{V}$		3150		pF
C_{oes}	Output Capacitance	$V_{CE} = 25\text{V}$		200		
C_{res}	Reverse Transfer Capacitance	$f = 1\text{MHz}$		95		
Q_G	Gate charge	$V_{GE} = \pm 15\text{V}, I_C = 50\text{A}$ $V_{CE} = 300\text{V}$		0.5		μC
$T_{d(on)}$	Turn-on Delay Time	Inductive Switching (25°C)		110		ns
T_r	Rise Time	$V_{GE} = \pm 15\text{V}$ $V_{Bus} = 300\text{V}$		45		
$T_{d(off)}$	Turn-off Delay Time	$I_C = 50\text{A}$		200		
T_f	Fall Time	$R_G = 8.2\Omega$		40		
$T_{d(on)}$	Turn-on Delay Time	Inductive Switching (150°C)		120		ns
T_r	Rise Time	$V_{GE} = \pm 15\text{V}$ $V_{Bus} = 300\text{V}$		50		
$T_{d(off)}$	Turn-off Delay Time	$I_C = 50\text{A}$		250		
T_f	Fall Time	$R_G = 8.2\Omega$		60		
E_{on}	Turn-on Switching Energy	$V_{GE} = \pm 15\text{V}$ $V_{Bus} = 300\text{V}$	$T_j = 25^\circ\text{C}$	0.3		mJ
			$T_j = 150^\circ\text{C}$	0.43		
E_{off}	Turn-off Switching Energy	$I_C = 50\text{A}$ $R_G = 8.2\Omega$	$T_j = 25^\circ\text{C}$	1.35		mJ
			$T_j = 150^\circ\text{C}$	1.75		
I_{sc}	Short Circuit data	$V_{GE} \leq 15\text{V}; V_{Bus} = 360\text{V}$ $t_p \leq 6\mu\text{s}; T_j = 150^\circ\text{C}$		250		A
R_{thJC}	Junction to Case Thermal Resistance				0.85	$^\circ\text{C}/\text{W}$

CR1 to CR4 diode ratings and characteristics

<i>Symbol</i>	<i>Characteristic</i>	<i>Test Conditions</i>		<i>Min</i>	<i>Typ</i>	<i>Max</i>	<i>Unit</i>
V _{RRM}	Maximum Peak Repetitive Reverse Voltage			600			V
I _{RM}	Maximum Reverse Leakage Current	V _R =600V	T _j = 25°C T _j = 150°C			150 350	μA
I _F	DC Forward Current		T _c = 80°C		30		A
V _F	Diode Forward Voltage	I _F = 30A V _{GE} = 0V	T _j = 25°C T _j = 150°C		1.6 1.5	2	V
t _{rr}	Reverse Recovery Time	I _F = 30A V _R = 300V di/dt = 1800A/μs	T _j = 25°C T _j = 150°C		100 150		ns
Q _{rr}	Reverse Recovery Charge		T _j = 25°C T _j = 150°C		1.5 3.1		μC
E _{rr}	Reverse Recovery Energy		T _j = 25°C T _j = 150°C		0.34 0.75		mJ
R _{thJC}	Junction to Case Thermal Resistance					2.45	°C/W

CR5 & CR6 diode ratings and characteristics

<i>Symbol</i>	<i>Characteristic</i>	<i>Test Conditions</i>		<i>Min</i>	<i>Typ</i>	<i>Max</i>	<i>Unit</i>
V _{RRM}	Maximum Peak Repetitive Reverse Voltage			600			V
I _{RM}	Maximum Reverse Leakage Current	V _R =600V	T _j = 25°C T _j = 150°C			150 350	μA
I _F	DC Forward current		T _c = 80°C		50		A
V _F	Diode Forward Voltage	I _F = 50A V _{GE} = 0V	T _j = 25°C T _j = 150°C		1.6 1.5	2	V
t _{rr}	Reverse Recovery Time	I _F = 50A V _R = 300V di/dt = 1800A/μs	T _j = 25°C T _j = 150°C		100 150		ns
Q _{rr}	Reverse Recovery Charge		T _j = 25°C T _j = 150°C		2.6 5.4		μC
E _{rr}	Reverse Recovery Energy		T _j = 25°C T _j = 150°C		0.60 1.20		mJ
R _{thJC}	Junction to Case Thermal Resistance					1.42	°C/W

Thermal and package characteristics

<i>Symbol</i>	<i>Characteristic</i>	<i>Min</i>	<i>Typ</i>	<i>Max</i>	<i>Unit</i>	
V _{ISOL}	RMS Isolation Voltage, any terminal to case t = 1 min, I _{isol} < 1mA, 50/60Hz	2500			V	
T _J	Operating junction temperature range	-40		175	°C	
T _{STG}	Storage Temperature Range	-40		125		
T _C	Operating Case Temperature	-40		100		
Torque	Mounting torque	To heatsink	M4	2.5	4.7	N.m
Wt	Package Weight				80	g

SP1 Package outline (dimensions in mm)

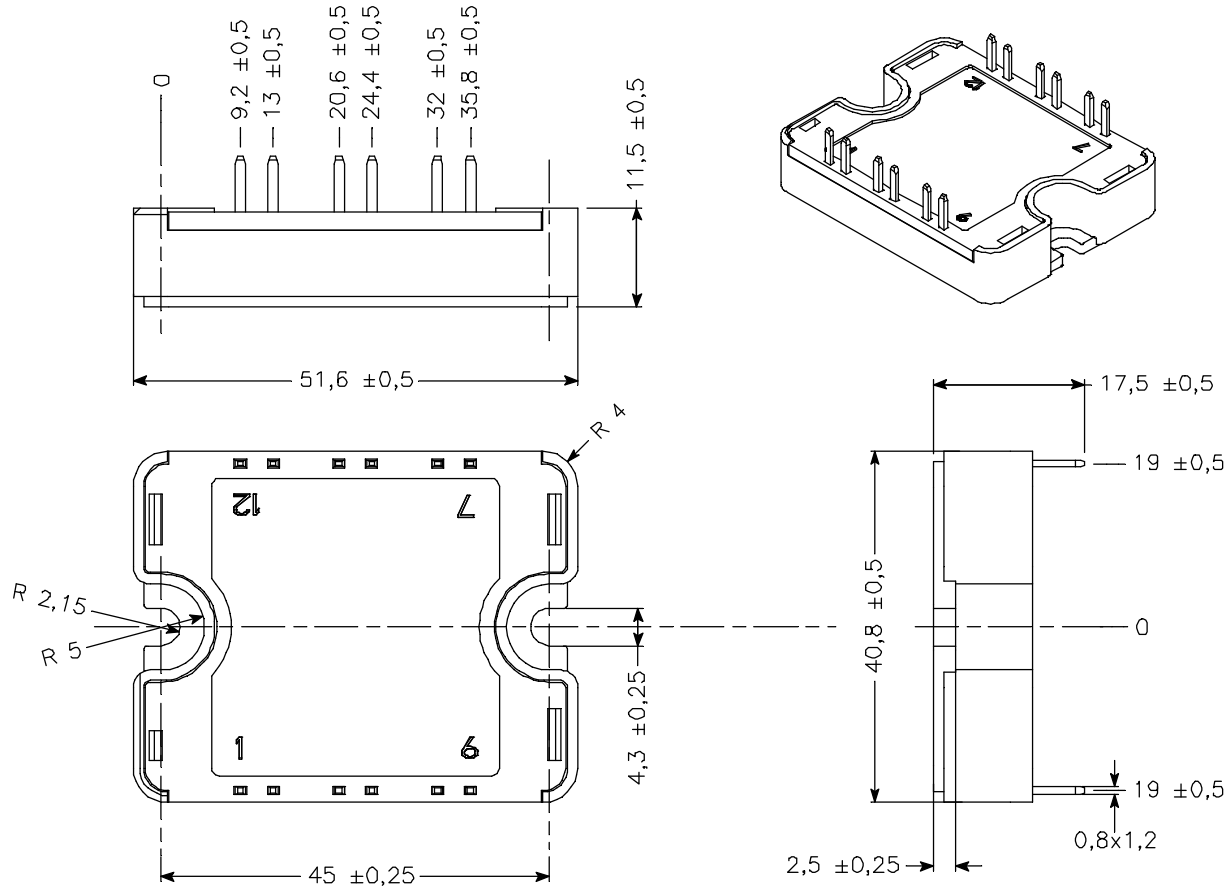

See application note 1904 - Mounting Instructions for SP1 Power Modules on www.microsemi.com

Q1 to Q4 Typical performance curve

Operating Frequency vs Collector Current

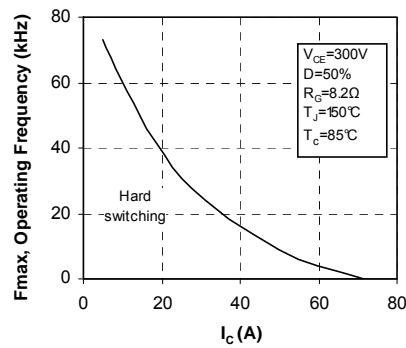

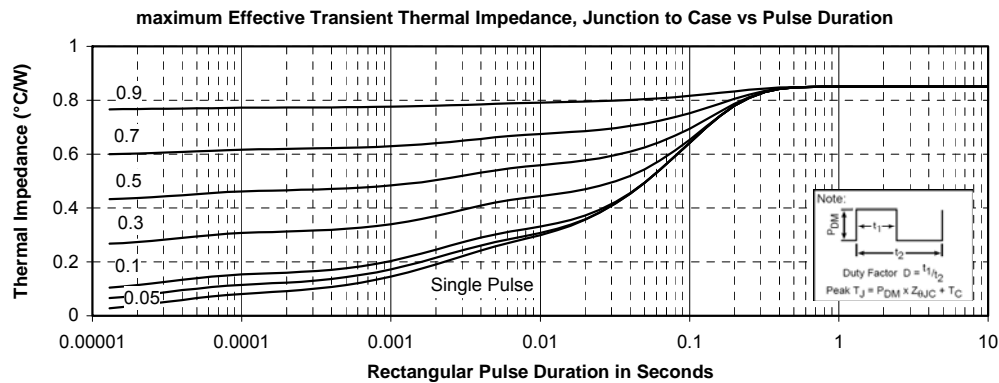
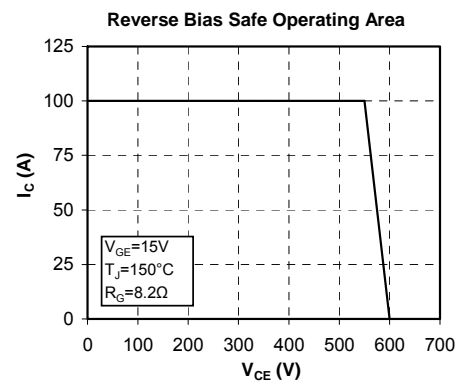
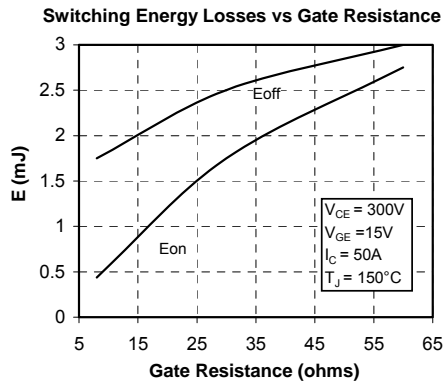
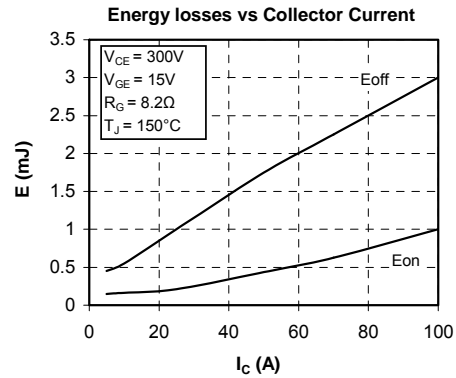
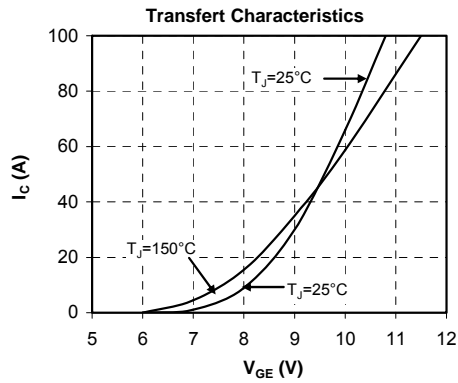
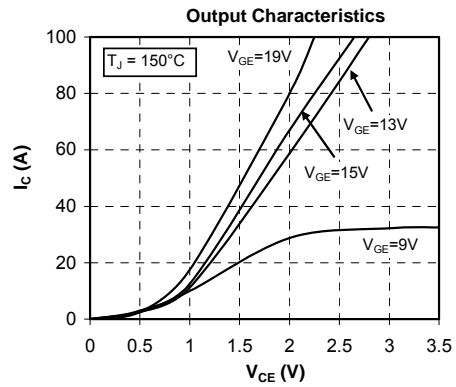
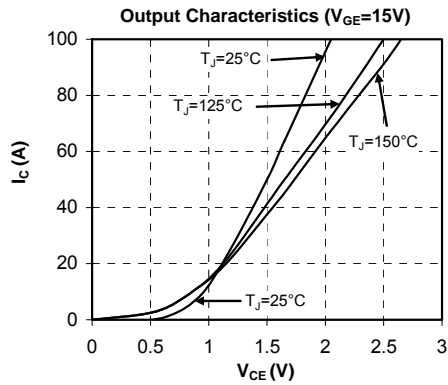

CR1 to CR4 Typical performance curve

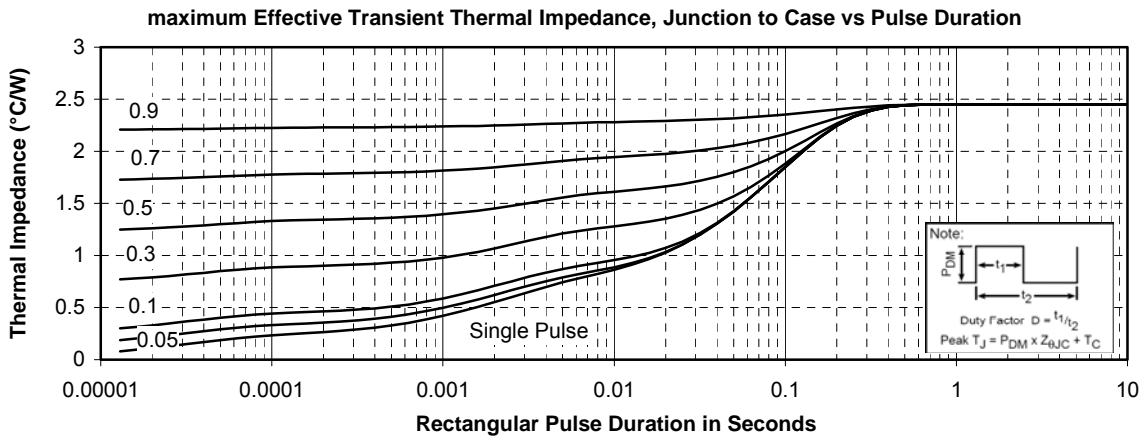
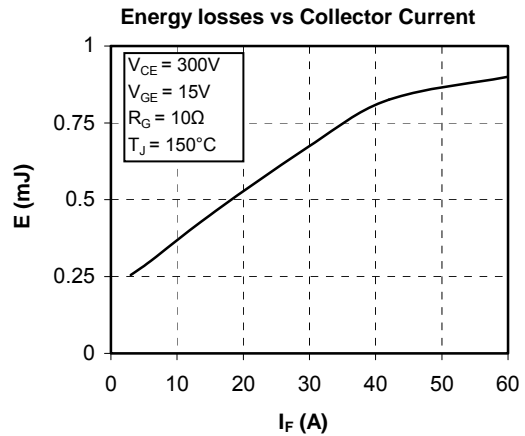
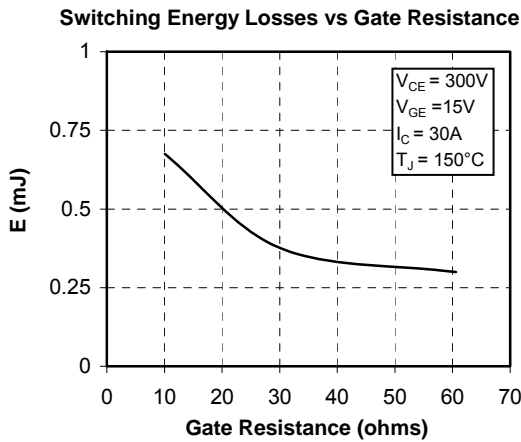
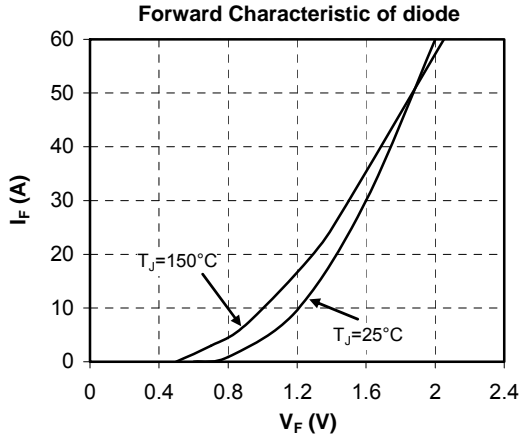

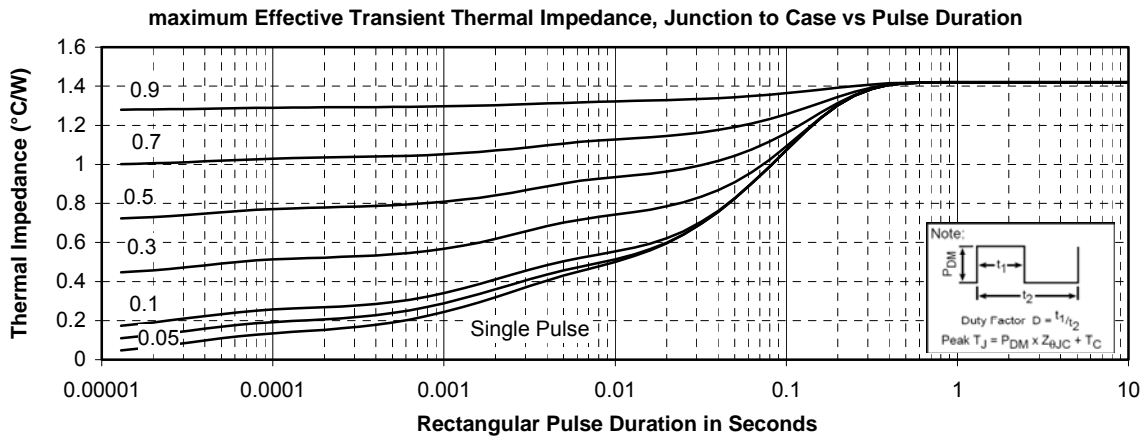
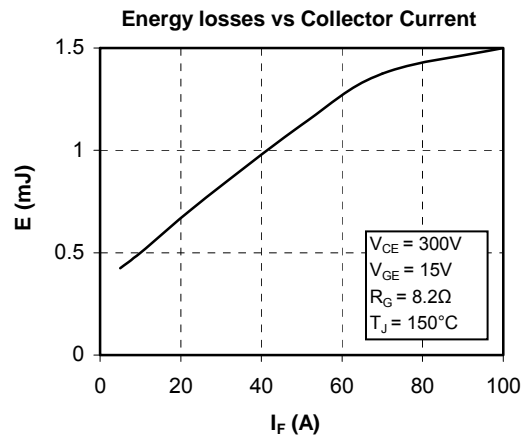
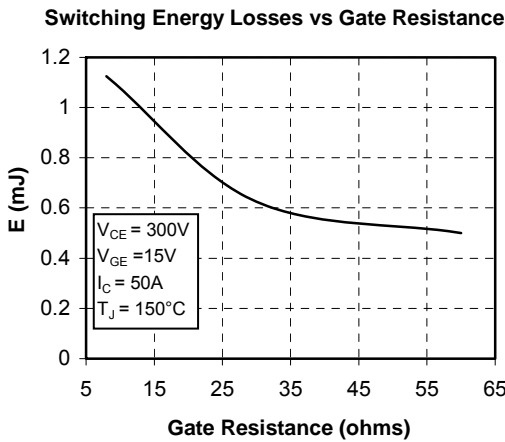
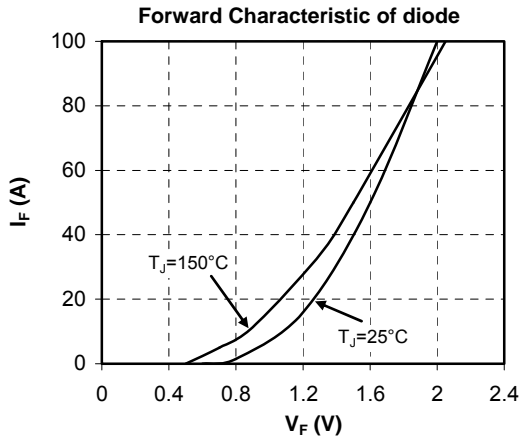
CR5 & CR6 Typical performance curve

Microsemi reserves the right to change, without notice, the specifications and information contained herein

Microsemi's products are covered by one or more of U.S. patents 4,895,810 5,045,903 5,089,434 5,182,234 5,019,522 5,262,336 6,503,786 5,256,583 4,748,103 5,283,202 5,231,474 5,434,095 5,528,058 6,939,743 7,352,045 5,283,201 5,801,417 5,648,283 7,196,634 6,664,594 7,157,886 6,939,743 7,342,262 and foreign patents. U.S and Foreign patents pending. All Rights Reserved.