

# FAN6747

## Highly Integrated Green-Mode PWM Controller

### Features

- High-Voltage JFET Startup
- AC-Line Brownout Protection by HV Pin
- Constant Output Power Limit by HV Pin (Full AC-Line Range)
- Two-Level Over-Current Protection (OCP) with 220ms Delay
- Short-Circuit Protection (SCP) with 15ms Delay as Output Short
- Peak-Current Mode Operation with Cycle-by-Cycle Current Limiting
- Low Startup Current: 30μA
- Low Operating Current: 1.7mA
- Over-Temperature Protection (OTP) with an External Negative-Temperature-Coefficient (NTC) Thermistor
- PWM Frequency Decreasing at Green-Mode
- V<sub>DD</sub> Over-Voltage Protection (OVP)
- Internal Latch Circuit for OVP, OTP, SCP, and OCP

### Applications

General-purpose switch-mode power supplies and flyback power converters, including:

- Power Adapters
- SMPS with Peak-Current Output, such as for Printers, Scanners, Motor Drivers
- AC/DC NB Adapters
- Open-Frame SMPS

### Description

The highly integrated FAN6747 PWM controller provides several features to enhance the performance of flyback converters. To minimize standby power consumption, a proprietary green-mode function provides off-time modulation to decrease the switching frequency with load condition.

Under zero-load condition, the power supply enters burst mode and burst frequency can be low to save more power. Green-mode function enables the power supply to meet international power conservation requirements.

The FAN6747 is especially designed for SMPS with peak-current output. It incorporates a cycle-by-cycle current limiting and two-level Over-Current-Protection (OCP) that can handle peak load with a delay time. Once the current is over the threshold level, it triggers the first counter 15ms and checks if V<sub>DD</sub> is below 10V; if it is, the PWM latches off for SCP. If V<sub>DD</sub> is higher than 10V; it keeps counting to 220ms, then the PWM latches off for OCP.

FAN6747 also integrates a frequency-hopping function internally to help reduce EMI emission of a power supply with minimum line filters. Built-in proprietary internal synchronized slope compensation achieves constant output power limit over universal AC line range. The gate output is clamped at 14V to protect the external MOSFET from over-voltage damage.

Other protection functions include AC-line brownout protection with hysteresis and V<sub>DD</sub> over-voltage protection. For over-temperature protection, an external NTC thermistor can be applied to sense the ambient temperature. When OCP, OVP, SCP, or OTP is activated, an internal latch circuit latches off the controller. The latch is reset when the V<sub>DD</sub> supply is removed.

### Ordering Information

Part Number	Operating Temperature Range	 Eco Status	Package	Packing Method
FAN6747LMY	-40 to +105°C	Green	8-Lead, Small-Outline Integrated Circuit (SOIC), JEDEC MS-012, .15-Inch Narrow Body	Tape & Reel

 For Fairchild's definition of Eco Status, please visit: [http://www.fairchildsemi.com/company/green/rohs\\_green.html](http://www.fairchildsemi.com/company/green/rohs_green.html).

### Application Diagram

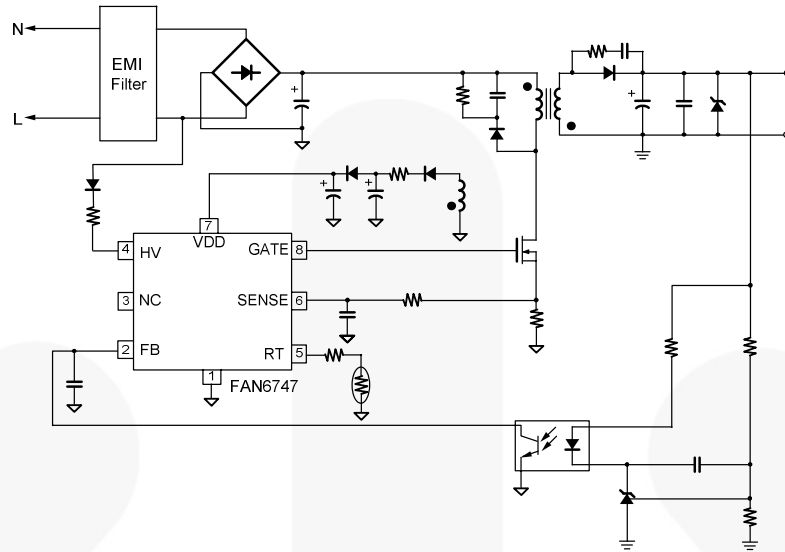

Figure 1. Typical Application

### Internal Block Diagram

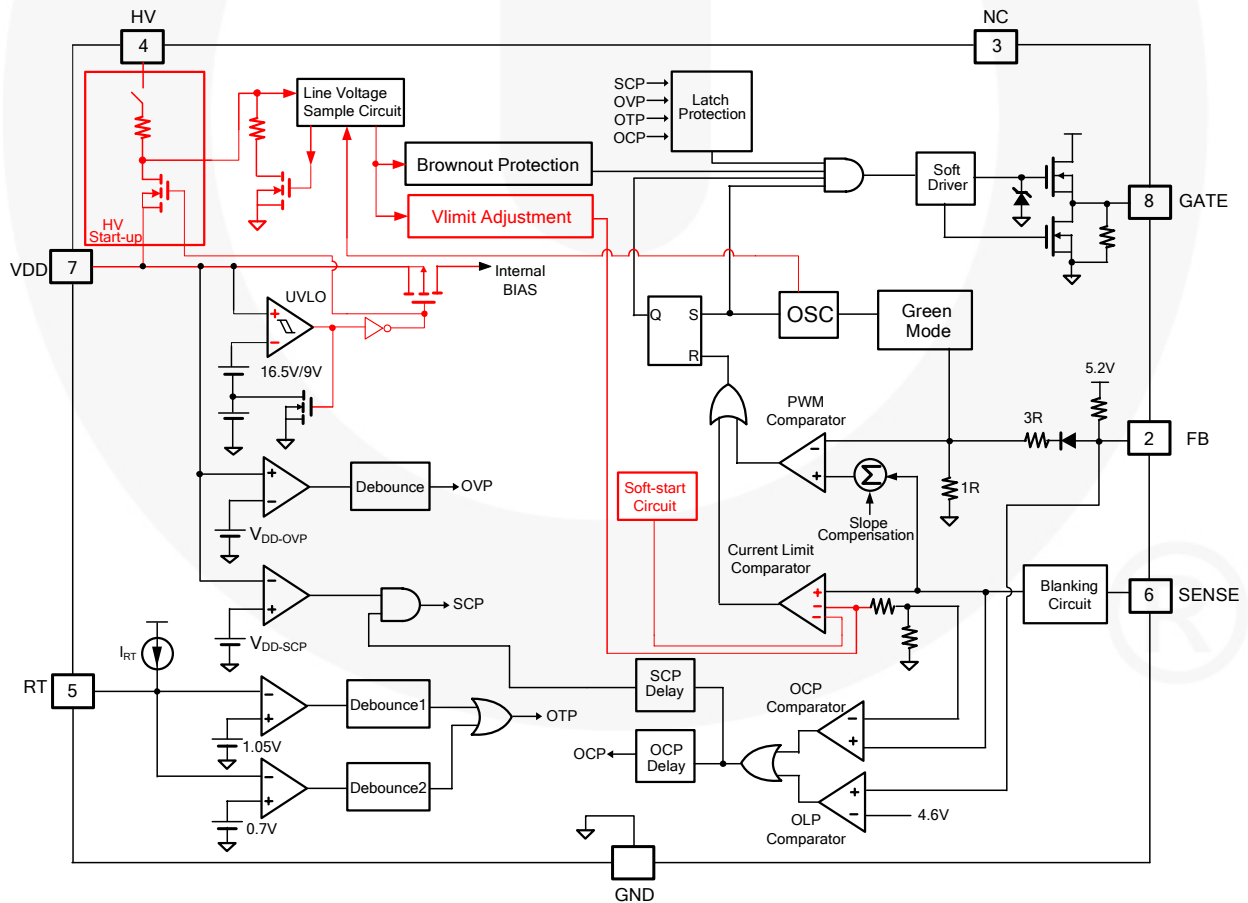
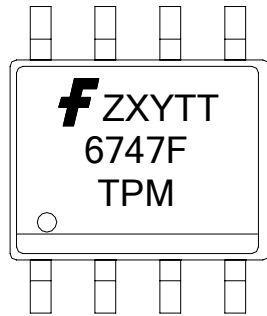

Figure 2. Functional Block Diagram

## Marking Information



- F**: Fairchild Logo
- Z**: Plant Code
- X**: Year Code
- Y**: Week Code
- TT**: Die Run Code
- F**: L = OCP latch
- T**: Package Type (N =DIP, M = SOP)
- P**: Y = Green Compound
- M**: Manufacturing Flow Code

Figure 3. Top Mark

## Pin Configuration

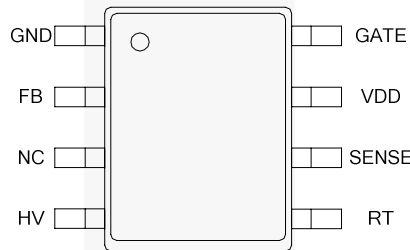

Figure 4. Pin Assignments

## Pin Definitions

Pin #	Name	Description
1	GND	<b>Ground.</b> This pin is used for the ground potential of all the pins. A 0.1 $\mu$ F decoupling capacitor placed between VDD and GND is recommended.
2	FB	<b>Feedback.</b> The output voltage feedback information from the external compensation circuit is fed into this pin. The PWM duty cycle is determined from this pin and the current-sense signal from Pin 6.
3	NC	<b>No Connection.</b>
4	HV	<b>High-Voltage Startup.</b> This pin is connected to the line input via diodes and resistors to achieve brownout and high/low line compensation. Once the voltage of the HV pin is lower than the brownout voltage, PWM output is turned off. High/low line compensation dominates the OCP level and cycle-by-cycle current limit, to solves the unequal OCP level and power limit problem under universal input.
5	RT	<b>Over-Temperature Protection.</b> For over-temperature protection, an external NTC thermistor is connected from this pin to GND. The impedance of the NTC decreases at high temperatures. Once the voltage of the RT pin drops below the threshold voltage, the controller latches off the PWM.
6	SENSE	<b>Current Sense.</b> This pin is used to sense the MOSFET current for the current mode PWM and OCP. If the switching current is higher than OCP threshold and lasts 220ms, the controller latches off the PWM.
7	VDD	<b>Supply Voltage.</b> IC operating current and MOSFET driving current are supplied using this pin. This pin is connected to an external bulk capacitor of typically 10 $\mu$ F. The threshold voltages for startup and turn-off are 16.5V and 9V, respectively. The operating current is lower than 2mA.
8	GATE	<b>Gate Driver Output.</b> The totem-pole output driver for the power MOSFET. It is internally clamped below 14V.

## Absolute Maximum Ratings

Stresses exceeding the absolute maximum ratings may damage the device. The device may not function or be operable above the recommended operating conditions and stressing the parts to these levels is not recommended. In addition, extended exposure to stresses above the recommended operating conditions may affect device reliability. The absolute maximum ratings are stress ratings only.

Symbol	Parameter	Min.	Max.	Unit
V <sub>DD</sub>	DC Supply Voltage		30	V
V <sub>HV</sub>	Suddenly Input Voltage to HV Pin within 1 Second (Series connect with R <sub>HV</sub> )		640	V
V <sub>L</sub>	Input Voltage to FB, SENSE, RT Pin	-0.3	7.0	V
P <sub>D</sub>	Power Dissipation (T <sub>A</sub> <50°C)		400	mW
θ <sub>JA</sub>	Thermal Resistance (Junction-to-Ambient)		141	°C/W
T <sub>J</sub>	Operating Junction Temperature	-40	+125	°C
T <sub>STG</sub>	Storage Temperature Range	-55	+150	°C
T <sub>L</sub>	Lead Temperature (Soldering, 10 Seconds)		+260	°C
ESD	Electrostatic Discharge Capability, All Pins Except HV Pin	Human Body Model, JESD22-A114	4.50	kV
		Charge Device Model, JESD22-C101	1.5	

### Notes:

1. Stresses beyond those listed under Absolute Maximum Ratings may cause permanent damage to the device.
2. All voltage values, except differential voltages, are given with respect to the network ground terminal.

## Recommended Operating Conditions

The Recommended Operating Conditions table defines the conditions for actual device operation. Recommended operating conditions are specified to ensure optimal performance to the datasheet specifications. Fairchild does not recommend exceeding them or designing to Absolute Maximum Ratings.

Symbol	Parameter	Conditions	Min.	Typ.	Max.	Unit
T <sub>A</sub>	Operating Ambient Temperature		-40		+105	°C
V <sub>HV</sub>	Input Voltage to HV Pin				500	V
R <sub>HV</sub>	HV Startup Resistor		150	200	250	kΩ

## Electrical Characteristics

$V_{DD}=15V$  and  $T_A=25^\circ C$ , unless otherwise specified.

Symbol	Parameter	Conditions	Min.	Typ.	Max.	Units
<b>V<sub>DD</sub> Section</b>						
V <sub>OP</sub>	Continuously Operating Voltage				24	V
V <sub>DD-ON</sub>	Turn-On Threshold Voltage		15.5	16.5	17.5	V
V <sub>DD-OFF</sub>	PWM Turn-Off Threshold Voltage		8	9	10	V
V <sub>DD-OLP</sub>	Threshold Voltage on V <sub>DD</sub> for HV JFET Turn-On in Protection Condition	After Trigger OCP/ SCP/ OVP/ OTP	5.5	6.5	7.5	V
V <sub>DD-LH</sub>	Threshold Voltage on VDD Pin for Latch-Off Release Voltage		3.5	4.0	4.5	V
V <sub>DD-AC</sub>	Threshold Voltage on VDD Pin for Disable AC Recovery to Avoid Startup Failed		V <sub>DD-OFF</sub> +2.5	V <sub>DD-OFF</sub> +3.0	V <sub>DD-OFF</sub> +3.5	V
V <sub>DD-SCP</sub>	Threshold Voltage on VDD Pin for Short-Circuit Protection (SCP)	V <sub>FB</sub> > V <sub>FB0</sub>	V <sub>DD-OFF</sub> +0.5	V <sub>DD-OFF</sub> +1.0	V <sub>DD-OFF</sub> +1.5	V
I <sub>LH</sub>	Holding Current Under Latch-Off Conduction	V <sub>DD</sub> =5V	80	100	120	μA
I <sub>DD-ST</sub>	Startup Current	V <sub>DD-ON</sub> - 0.16V			30	μA
I <sub>DD-OLP</sub>	Holding Current at PWM-Off Phase	V <sub>DD-OLP</sub> +0.1V	235	270	305	μA
I <sub>DD-OP1</sub>	Operating Supply Current when PWM Operating	V <sub>DD</sub> =20V, V <sub>FB</sub> =3V Gate Open		1.7	2.0	mA
I <sub>DD-OP2</sub>	Operating Supply Current when PWM Stop	V <sub>DD</sub> =20V, V <sub>FB</sub> =3V Gate Open		1.2	1.5	mA
V <sub>DD-OVP</sub>	Threshold Voltage on VDD Pin for V <sub>DD</sub> Over-Voltage Protection (Latch-Off)		24	25	26	V
t <sub>D-OVP</sub>	V <sub>DD</sub> OVP Debounce Time	V <sub>FB</sub> > V <sub>FB-N</sub>	75	160	245	μs

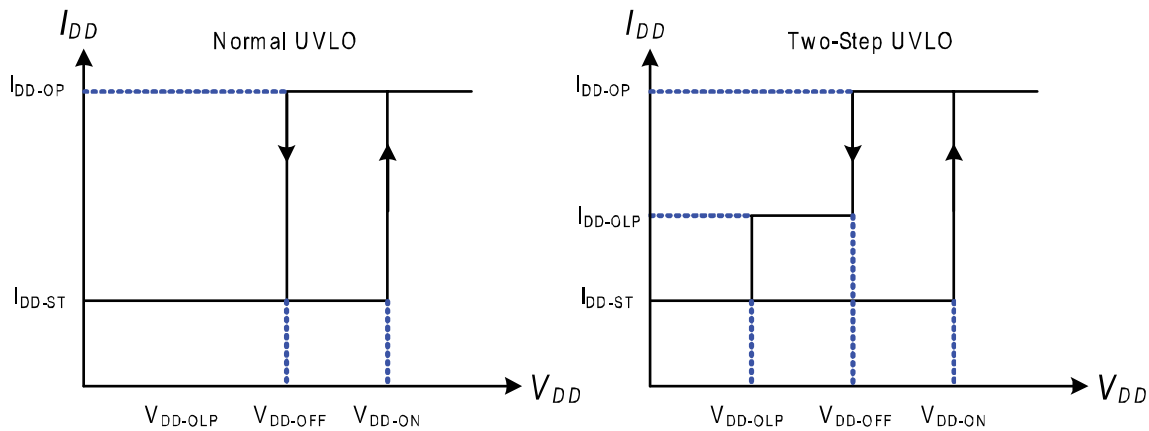
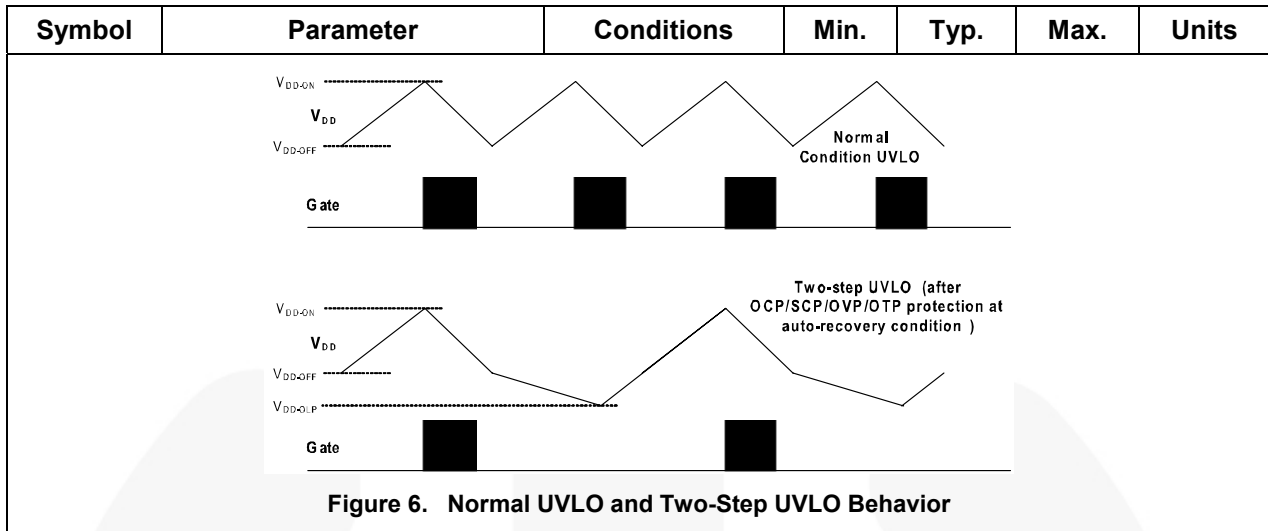

Figure 5. UVLO Specification

Continued on the following page...

## Electrical Characteristics

$V_{DD}=15V$  and  $T_A=25^\circ C$ , unless otherwise specified.



**Figure 6. Normal UVLO and Two-Step UVLO Behavior**

### HV Section

Symbol	Parameter	Conditions	Min.	Typ.	Max.	Units
$I_{HV}$	Supply Current Drawn from HV Pin	$V_{HV}=120V, V_{DD}=0V$	1.50	2.75	4.00	mA
$V_{IN-OFF}$	PWM Turn-Off Threshold	DC Source Series $R=200k$ to HV Pin	92	102	112	V
$V_{IN-ON}$	PWM Turn-On Threshold	DC Source Series $R=200k$ to HV Pin	104	114	124	V
$\Delta V_{IN}$	Change in $V_{IN}$ , $V_{IN-ON} - V_{IN-OFF}$	DC Source Series $R=200k$ to HV Pin	6	12	18	V
$t_{S-CYCLE}$	Line Voltage Sample cycle	$V_{FB} > V_{FB-N}$	170	205	240	$\mu s$
		$V_{FB} < V_{FB-G}$	450	615	780	
$t_{S-TIME}$	Line Voltage Sample Period			20		$\mu s$
$t_{D\_VIN-OFF}$	PWM Turn-Off Debounce Time	$V_{FB} > V_{FB-N}$	65	75	85	ms
		$V_{FB} < V_{FB-G}$	180	235	290	ms

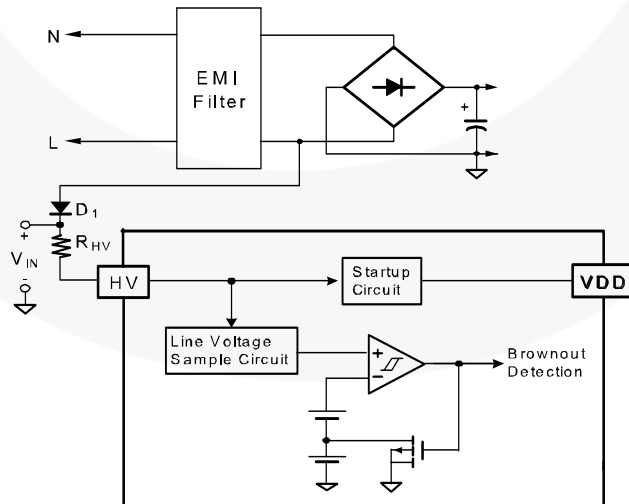

**Figure 7. Brownout Circuit**

## Electrical Characteristics

$V_{DD}=15V$  and  $T_A=25^\circ C$ , unless otherwise specified.

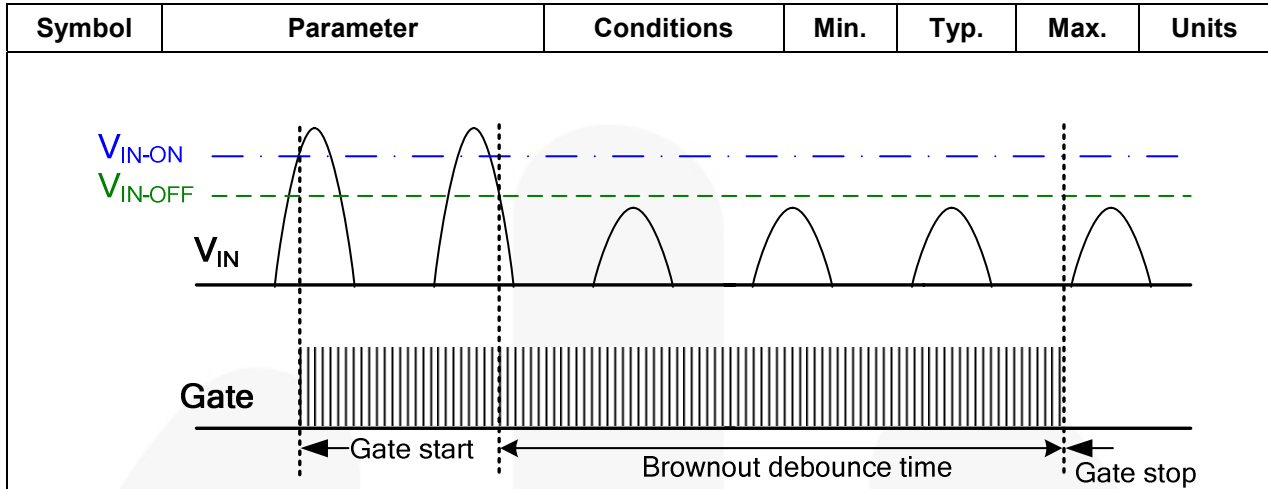

Figure 8. Brownout Behavior

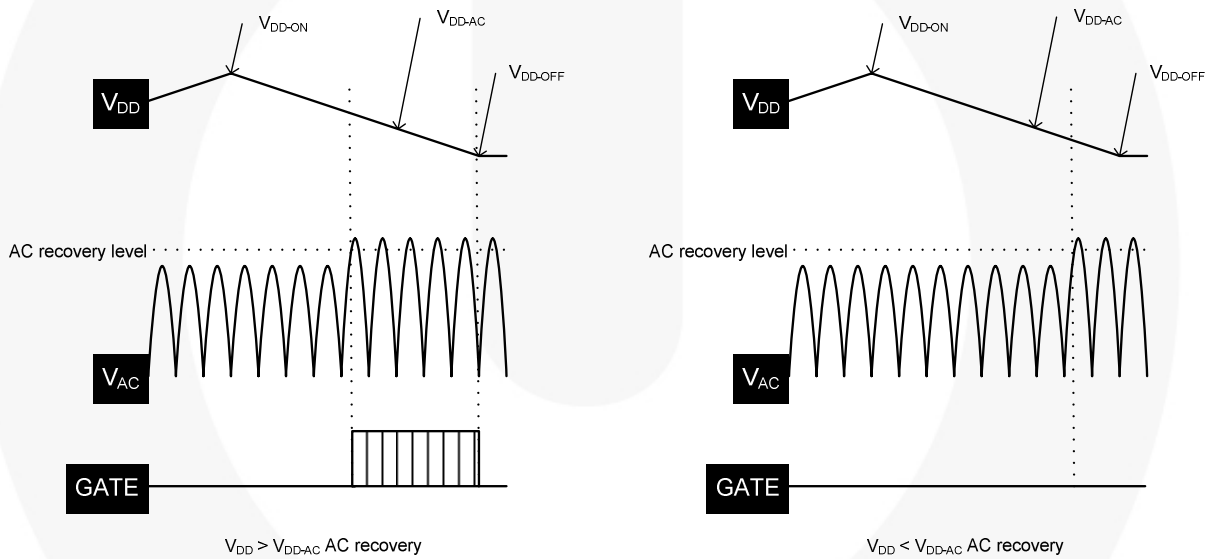

Figure 9.  $V_{DD-AC}$  and AC Recovery

### Oscillator Section

$f_{OSC}$	Normal PWM Frequency	Center Frequency ( $V_{FB} > V_{FB-N}$ )	61	65	69	kHz
$t_{JTR-1}$	Jitter Period 1	$V_{FB} > V_{FB-N}$	3.9	4.4	4.9	ms
$t_{JTR-3}$	Jitter Period 3	$V_{FB} = V_{FB-G}$	10.2	11.5	12.8	ms
$f_{OSC-G}$	Green-Mode Minimum Frequency		19	22	25	kHz
$V_{FB-N}$	FB Threshold Voltage for Frequency Reduction Beginning	Pin, FB Voltage ( $V_{FB} = V_{FB-N}$ ), $f_{OSC} - 5KHZ$	2.6	2.8	3.0	V
		Jitter Range	$\pm 3.7$	$\pm 4.2$	$\pm 4.7$	kHz
$V_{FB-G}$	FB Threshold Voltage for Turn-Off Jitter and Frequency Reduction Destination	Pin, FB Voltage ( $V_{FB} = V_{FB-G}$ )	2.1	2.3	2.5	V
		Jitter Range		$\pm 1.45$		kHz

## Electrical Characteristics

$V_{DD}=15V$  and  $T_A=25^{\circ}C$ , unless otherwise specified.

Symbol	Parameter	Conditions	Min.	Typ.	Max.	Units
$S_G$	Slope for Green-Mode Modulation			85		Hz/mV-
$V_{OZ-ON}$	FB Threshold Voltage for Zero-Duty Recovery		1.6	1.8	2.0	V
$V_{FB-ZDC}$ ( $V_{OZ-OFF}$ )	FB Threshold Voltage for Zero-Duty		1.5	1.7	1.9	V
$V_{OZ-ON}$ - $V_{OZ-OFF}$	FB Voltage Hysteresis for $V_{OZ-ON}$ to $V_{OZ-OFF}$		50	100	150	mV
$f_{DV}$	Frequency Variation vs. $V_{DD}$ Deviation	$V_{DD}=12V$ to $22V$			5	%
$f_{DT}$	Frequency Variation vs. Temperature Deviation	$T_A=-40$ to $105^{\circ}C$			5	%

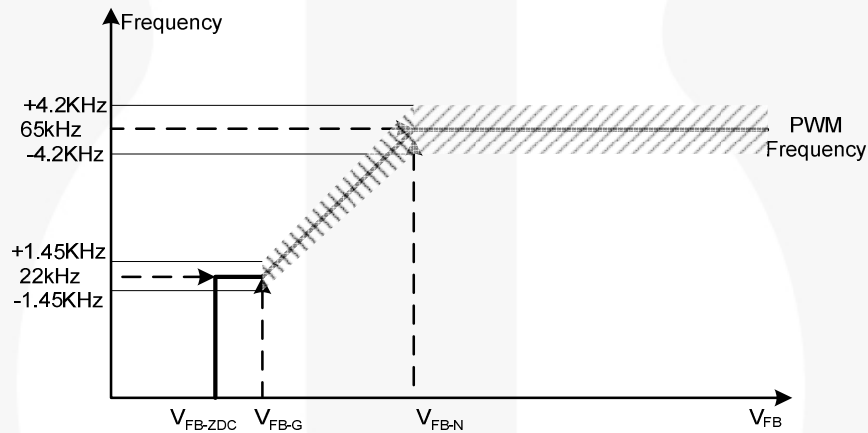

Figure 10. PWM Frequency

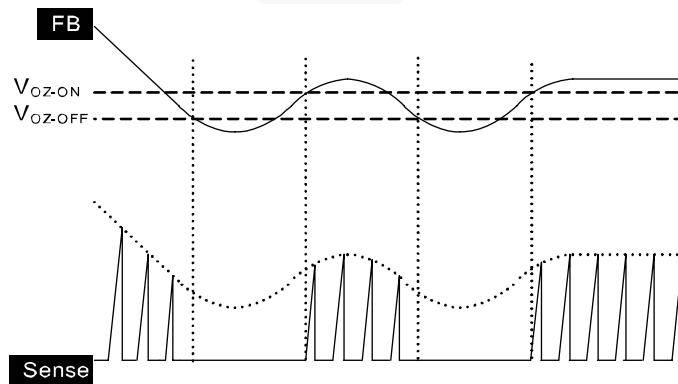

Figure 11. Burst-Mode Diagram

### Feedback Input Section

$A_V$	Input-Voltage to Current-Sense Attenuation	$V_{FB} < V_{FB-G}$	1/4.5	1/4.0	1/3.5	V/V
$Z_{FB}$	Input Impedance		13.4	15.5	17.6	$k\Omega$
$V_{FBO}$	FB Pin Open Voltage		4.8	5.0	5.2	V
$V_{FB-OLP}$	FB Open-Loop Protection Threshold Voltage		4.3	4.6	4.9	V
$t_{D-OLP}$	Open-Loop Protection Delay		190	215	240	ms



## Electrical Characteristics

$V_{DD}=15V$  and  $T_A=25^{\circ}C$ , unless otherwise specified.

Symbol	Parameter	Conditions	Min.	Typ.	Max.	Units
<b>Current Sense Section</b>						
$t_{PD}$	Delay to Output			65	200	ns
$t_{LEB}$	Leading-Edge Blanking Time		230	270	310	ns
$V_{limit-L}$	Current Limit at Low Line ( $V_{AC-RMS}=86V$ )	$V_{DC}=122V$ , Series $R=200k\Omega$ to HV	0.790	0.825	0.860	V
$V_{limit-H}$	Current Limit at High Line ( $V_{AC-RMS}=259V$ )	$V_{DC}=366V$ , Series $R=200k\Omega$ to HV	0.690	0.725	0.760	V
$V_{OCP-L}$	OCP Trigger Level at Low Line ( $V_{AC-RMS}=86V$ )	$V_{DC}=122V$ , Series $R=200k\Omega$ to HV	0.450	0.480	0.510	V
$V_{OCP-H}$	OCP Trigger Level at High Line ( $V_{AC}=259V$ )	$V_{DC}=366V$ , Series $R=200k\Omega$ to HV	0.390	0.420	0.450	V
$t_{SOFT-START}$	Period During Startup	Startup Time	7	8	9	ms
$t_{D-OCP}$	Delay Time for Output OCP	$V_{CS}>V_{OCP}$	190	215	240	ms
$t_{D-SCP}$	Delay Time for Output SCP	$V_{CS}>V_{OCP}$ and $V_{DD}<V_{DD-SCP}$	12	15	18	ms
<b>PWM Output Section</b>						
$DCY_{MAX}$	Maximum Duty Cycle		88.0	89.5	91.0	%
$V_{OL}$	Output Voltage Low	$V_{DD} = 15V, I_O=50mA$			1.5	V
$V_{OH}$	Output Voltage High	$V_{DD} = 12V, I_O=50mA$	8			V
$t_R$	Rising Time	$GATE=1nF$		95		ns
$t_F$	Falling Time	$GATE=1nF$		30		ns
$V_{CLAMP}$	Gate Output Clamping Voltage	$V_{DD}=22V$	11.0	13.5	16.0	V
<b>Over-Temperature Protection Section</b>						
$I_{RT}$	Output Current of RT Pin		92	100	108	$\mu A$
$V_{OTP-LATCH-OFF}$	Threshold Voltage for Over-Temperature Protection		1.00	1.05	1.10	V
$t_{D\_OTP-LATCH}$	Over-Temperature Latch-Off Debounce	$V_{FB} > V_{FB-N}$	14	16	18	ms
		$V_{FB} < V_{FB-G}$	40	51	62	ms
$V_{OTP2-LATCH-OFF}$	Second Threshold Voltage for Over-Temperature Protection		0.65	0.70	0.75	V
$t_{D\_OTP2-LATCH}$	Second Over-Temperature Latch-Off Debounc	$V_{FB} > V_{FB-N}$	110	185	260	$\mu s$
		$V_{FB} < V_{FB-G}$	320	605	890	

## Typical Performance Characteristics

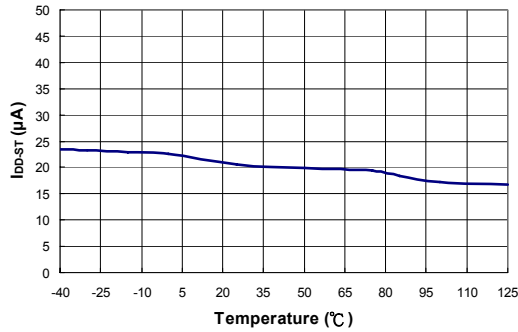

Figure 12. Startup Current ( $I_{DD-ST}$ ) vs. Temperature

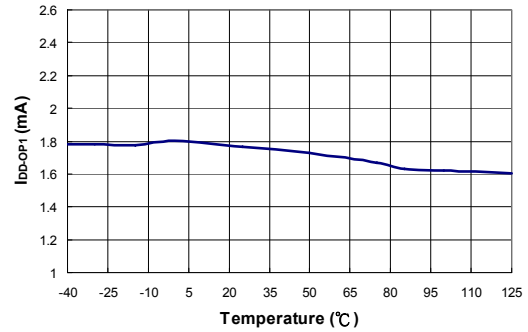

Figure 13. Operation Supply Current ( $I_{DD-OP1}$ ) vs. Temperature

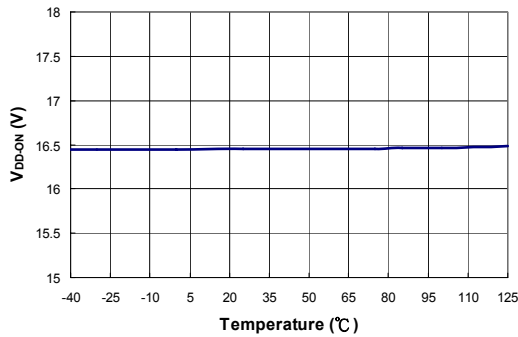

Figure 14. Start Threshold Voltage ( $V_{DD-ON}$ ) vs. Temperature

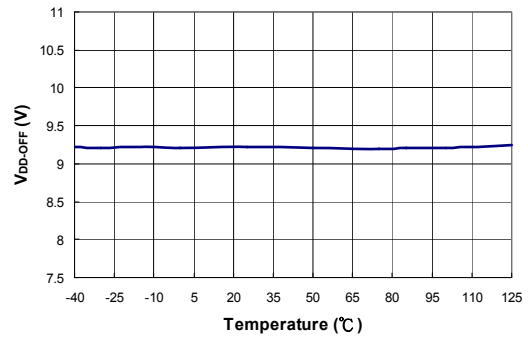

Figure 15. Minimum Operating Voltage ( $V_{DD-OFF}$ ) vs. Temperature

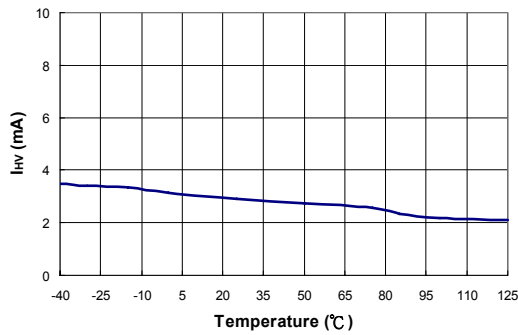

Figure 16. Supply Current Drawn from HV Pin ( $I_{HV}$ ) vs. Temperature

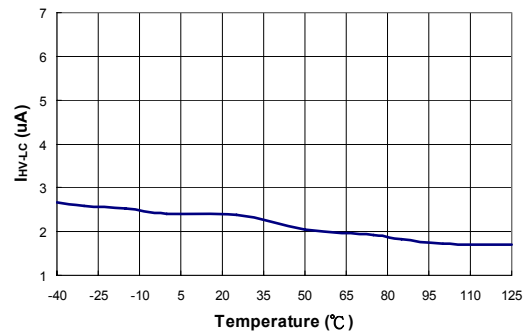

Figure 17. HV Pin Leakage Current After Startup ( $I_{HV-LC}$ ) vs. Temperature

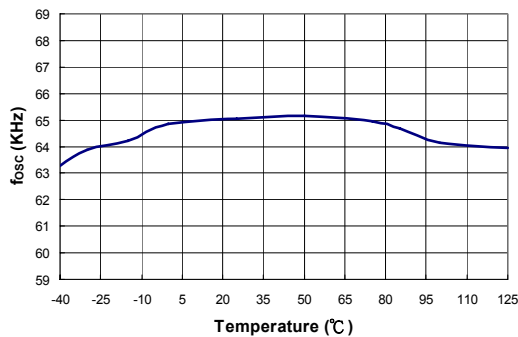

Figure 18. Frequency in Normal Mode ( $f_{osc}$ ) vs. Temperature

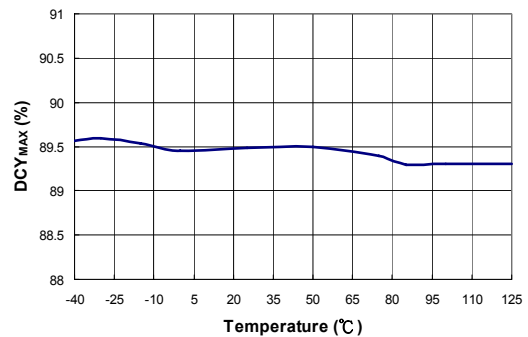

Figure 19. Maximum Duty Cycle ( $DCY_{MAX}$ ) vs. Temperature

## Typical Performance Characteristics

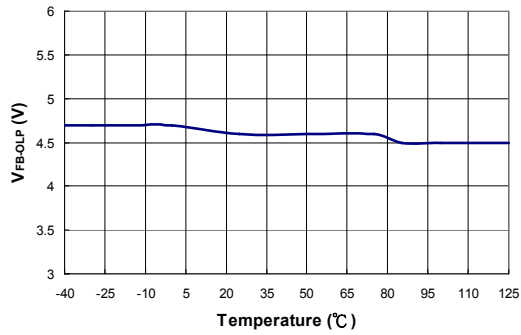

Figure 20. FB Open-Loop Trigger Level (V<sub>FB-OLP</sub>) vs. Temperature

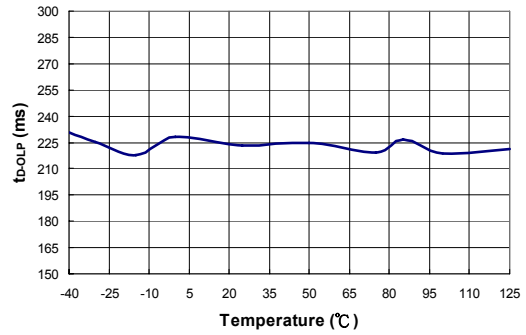

Figure 21. Delay Time of FB Pin Open-Loop Protection (t<sub>D-OLP</sub>) vs. Temperature

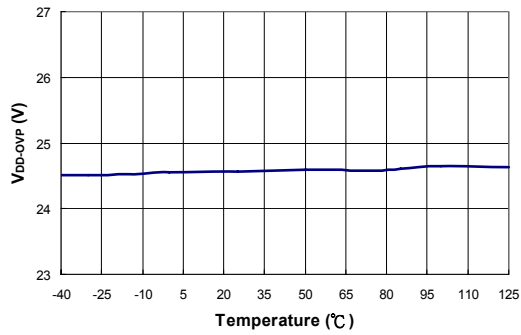

Figure 22. V<sub>DD</sub> Over-Voltage Protection (V<sub>DD-OVP</sub>) vs. Temperature

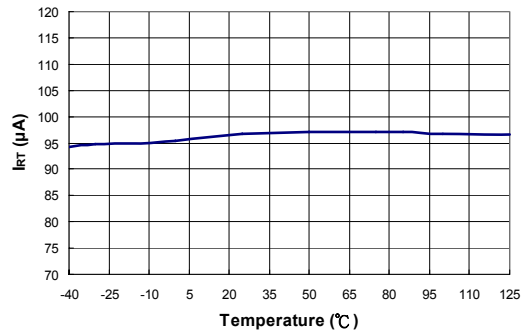

Figure 23. Output Current from RT Pin (I<sub>RT</sub>) vs. Temperature

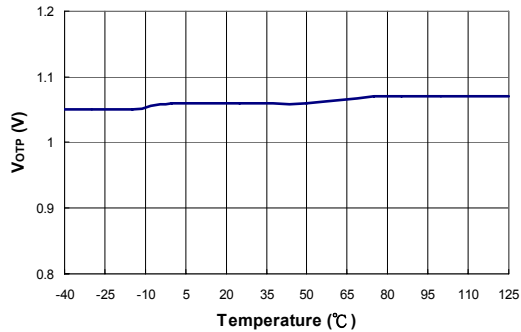

Figure 24. Over-Temperature Protection Threshold Voltage (V<sub>OTP</sub>) vs. Temperature

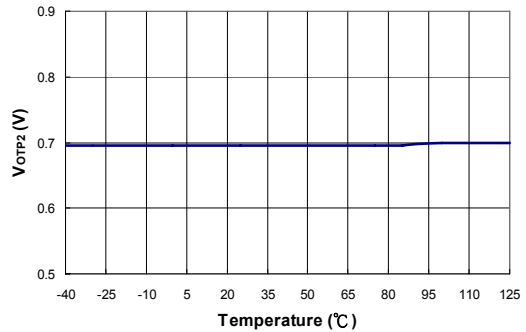

Figure 25. Over-Temperature Protection Threshold Voltage (V<sub>OTP2</sub>) vs. Temperature

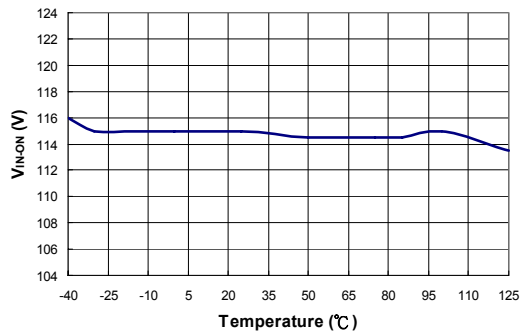

Figure 26. Brown-In (V<sub>IN-ON</sub>) vs. Temperature

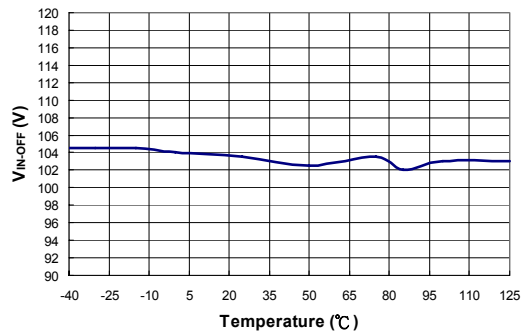

Figure 27. Brownout (V<sub>IN-OFF</sub>) vs. Temperature

## Operation Description

### Startup Current

For startup, the HV pin is connected to the line input through an external diode and resistor,  $R_{HV}$ , (1N4007 / 200K $\Omega$  recommended). Peak startup current drawn from the HV pin is  $(V_{AC} \times \sqrt{2})/R_{HV}$  and charges the hold-up capacitor through the diode and resistor. When the  $V_{DD}$  capacitor level reaches  $V_{DD-ON}$ , the startup current switches off. At this moment, the  $V_{DD}$  capacitor only supplies the FAN6747 to maintain the  $V_{DD}$  before the auxiliary winding of the main transformer provides the operating current.

### Operating Current

Operating current is around 2mA. The low operating current enables better efficiency, power saving, and reduces the requirement of  $V_{DD}$  hold-up capacitance.

### Green-Mode Operation

The proprietary green-mode function provides off-time modulation to reduce the switching frequency in light-load and no-load conditions.  $V_{FB}$ , which is derived from the voltage feedback loop, is taken as the reference. Once  $V_{FB}$  is lower than the threshold voltage, switching frequency is continuously decreased to the minimum green-mode frequency of around 22KHz.

### Two-Level Over-Current Protection (OCP)

The cycle-by-cycle current limiting shuts down the PWM immediately when the sense voltage is over the limited threshold voltage (0.825V at low line). Additionally, when the sense voltage is higher than the OCP threshold (0.48V at low line), the internal counter counts for 220ms, then latches off PWM. When OCP occurs, PWM output is turned off and  $V_{DD}$  begins decreasing.

When  $V_{DD}$  goes below the turn-off threshold (~9V), the controller is totally shut down.  $V_{DD}$  continues to discharge below  $V_{DD-OLP}$  by  $I_{DD-OLP}$ . Then  $V_{DD}$  is charged up to the turn-on threshold voltage of 16.5V through the startup resistor. When  $V_{DD}$  is charged to 16.5V, it cycles again. This phenomenon is called two-level UVLO.

### Brownout and Constant Power Limited HV Pin

Unlike previous PWM controllers, FAN6747's HV pin isn't only used for startup; it can also detect the AC line voltage to perform brownout function and set the current limit level. Through a fast diode and startup resistor to sample the AC line voltage, the peak value refreshes and stores in register at each sampling cycle. When internal update time is met, this peak value is used to for brownout and current-limit level judgment. Equations 1 and 2 can be used to calculate out the level of brown-in or brownout converted to RMS value. For power saving, FAN6747 enlarges the sampling cycle to lower the power loss from HV sampling at light-load condition.

$$V_{AC-ON}(RMS) = (0.9 \times \frac{R_{HV} + 1.6}{1.6}) / \sqrt{2} \quad (1)$$

$$V_{AC-OFF}(RMS) = (0.81 \times \frac{R_{HV} + 1.6}{1.6}) / \sqrt{2} \quad (2)$$

### Short-Circuit Protection (SCP)

This protection is used to handle the huge output demand if the power supply output is suddenly shorted to ground. If  $V_{DD}$  drops under 10V and the sensed voltage is higher than the limited threshold voltage, SCP is triggered and PWM output is latched off. This latch condition is reset only if  $V_{DD}$  is discharged under 4V or by unplugging AC power line.

### Under-Voltage Lockout (UVLO)

The turn-on and turn-off thresholds are fixed internally at 16.5V and 9V, respectively. During startup, the hold-up capacitor must be charged to 16.5V through the startup resistor to enable the IC. The hold-up capacitor continues to supply  $V_{DD}$  before the energy can be delivered from auxiliary winding of the main transformer.  $V_{DD}$  must not drop below 9V during startup. This UVLO hysteresis window ensures that the hold-up capacitor is adequate to supply  $V_{DD}$  during startup.

### Leading-Edge Blanking (LEB)

Each time the power MOSFET is switched on, a turn-on spike occurs on the sense-resistor. To avoid premature termination of the switching pulse, a leading-edge blanking time is built in. During this blanking period, the current-limit comparator is disabled and can not switch off the gate driver.

### Gate Output / Soft Driving

The BiCMOS output stage is a fast totem-pole gate driver. Cross conduction has been avoided to minimize heat dissipation, increase efficiency, and enhance reliability. The output driver is clamped by an internal 13.5V Zener diode to protect power MOSFET transistors against undesirable gate over voltage. A soft driving waveform is implemented to minimize EMI.

### $V_{DD}$ Over-Voltage Protection (OVP)

$V_{DD}$  over-voltage protection is built in to prevent damage due to abnormal conditions. If the  $V_{DD}$  voltage is over the over-voltage protection voltage ( $V_{DD-OVP}$ ) and lasts for  $t_{D-OVP}$ , the PWM pulses are disabled until the  $V_{DD}$  voltage drops below 4V, then restarts again.

### Soft-Start

For many applications, it is necessary to minimize the inrush current at startup. The built-in 8ms soft-start circuit significantly reduces the startup current spike and output voltage overshoot.

### Built-In Slope Compensation

The sensed voltage across the current-sense resistor is used for peak-current-mode control and pulse-by-pulse current limiting. Built-in slope compensation improves stability and prevents sub-harmonic oscillation. FAN6747 inserts a synchronized, positive-going, ramp at every switching cycle.

### Constant Output Power Limit

When the SENSE voltage across sense resistor  $R_S$  reaches the threshold voltage, the output GATE drive is turned off after a small delay,  $t_{PD}$ . This delay introduces an additional current proportional to  $t_{PD} \cdot V_{IN} / L_P$ . Since the delay is nearly constant regardless of the input voltage  $V_{IN}$ , higher input voltage results in a larger additional current and the output power limit is higher than under low input line voltage. To compensate this variation for a wide AC input range, a power-limiter is controlled by HV pin to solve the unequal power-limit problem. The power limiter is fed to the inverting input of the OCP comparator. This results in a lower current limit at high-line input than at low-line input.

### Over-Temperature Protection (OTP)

A NTC thermistor,  $R_{NTC}$ , in series with a resistor,  $R_A$ , is connected from the RT pin to GND pin. A constant current  $I_{RT}$  is output from this pin. The voltage of the RT pin can be expressed as  $V_{RT} = I_{RT} \cdot (R_{NTC} + R_A)$ , where  $I_{RT}$  is  $100\mu A$ , the headroom of  $V_{RT}$  is limited at around 5V by internal circuitry. As high ambient temperatures occur,  $R_{NTC}$  is smaller, such that the  $V_{RT}$  decreases. When  $V_{RT}$  is less than  $1.05V(V_{OTP})$  but over 0.7V, the PWM turns off after  $t_{D\_OTP-LATCH}$ . The other threshold,  $V_{DD}$  under 0.7V, is used for fast shut down of FAN6747 after a short time.

### Noise Immunity

Noise on the current sense or control signal may cause significant pulse-width jitter, particularly in continuous-conduction mode. Slope compensation helps alleviate this problem. Good placement and layout practices should be followed. Avoiding long PCB traces and component leads, locating compensation and filter components near the FAN6747, and increasing the power MOS gate resistance improve performance.

Physical Dimensions

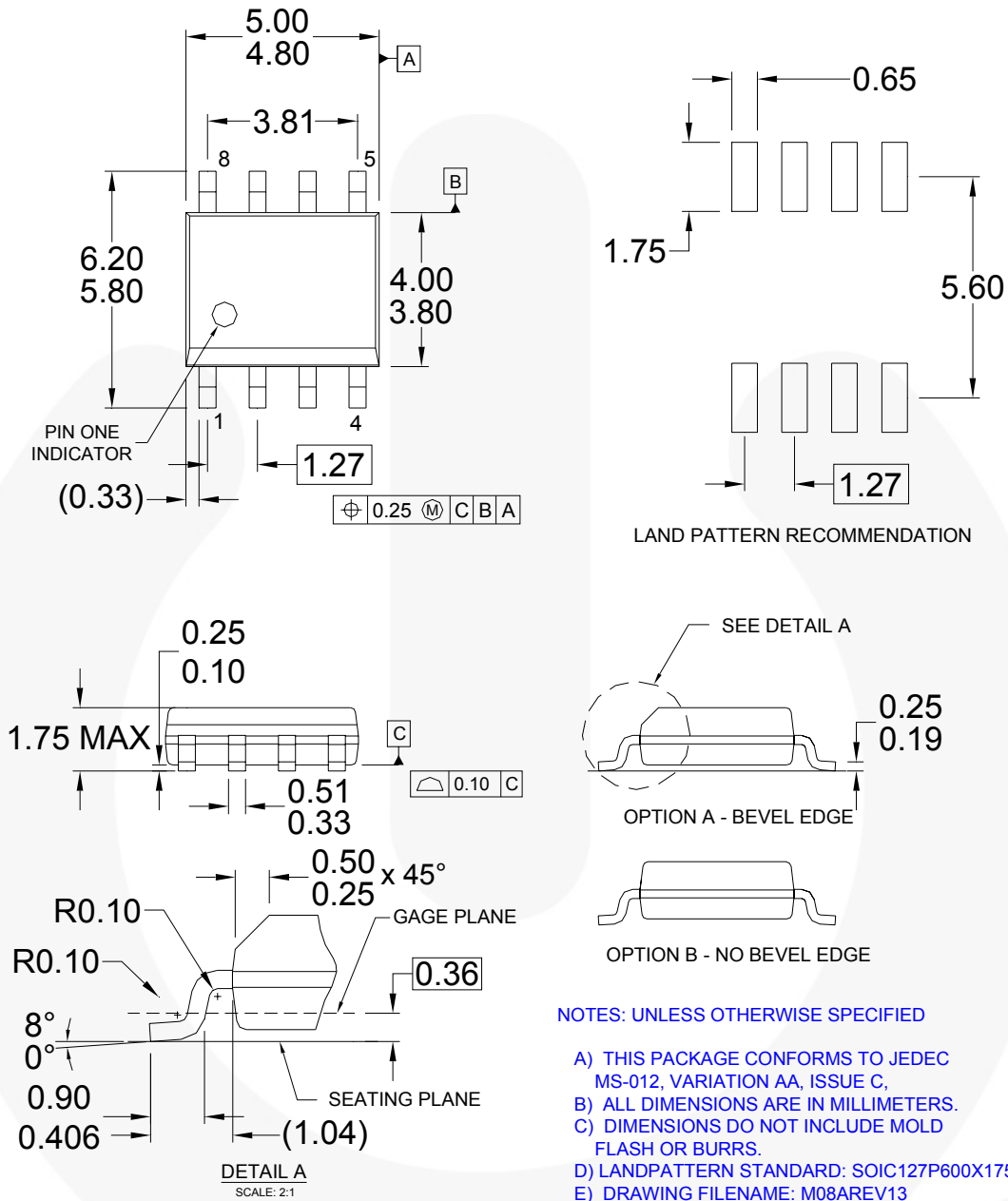

Figure 28. 8-Lead, Small Outline Integrated Circuit (SOIC) Package



Package drawings are provided as a service to customers considering Fairchild components. Drawings may change in any manner without notice. Please note the revision and/or date on the drawing and contact a Fairchild Semiconductor representative to verify or obtain the most recent revision. Package specifications do not expand the terms of Fairchild's worldwide terms and conditions, specifically the warranty therein, which covers Fairchild products.

Always visit Fairchild Semiconductor's online packaging area for the most recent package drawings:  
<http://www.fairchildsemi.com/packaging/>



**TRADEMARKS**

The following includes registered and unregistered trademarks and service marks, owned by Fairchild Semiconductor and/or its global subsidiaries, and is not intended to be an exhaustive list of all such trademarks.

- |   |                          |   |   |
|---|--------------------------|---|---|
| AccuPower™  | FlashWriter®*            | PDP SPM™  |  SYSTEM GENERAL®     |
| Auto-SPM™   | FPS™                     | Power-SPM™  | The Power Franchise®  |
| Build it Now™   | F-PFS™                   | PowerTrench®  |  the power franchise |
| CorePLUS™   | FRFET®                   | PowerXS™  | TinyBoost™  |
| CorePOWER™  | Global Power Resource SM | Programmable Active Droop™  | TinyBuck™   |
| CROSSVOLT™  | Green FPS™               | QFET®   | TinyCalc™   |
| CTL™  | Green FPS™ e-Series™     | QS™   | TinyLogic®  |
| Current Transfer Logic™   | Gmax™                    | Quiet Series™   | TINYOPTO™   |
| DEUXPEED®   | GTO™                     | RapidConfigure™   | TinyPower™  |
| Dual Cool™  | IntelliMAX™              |  ™ | TinyPWM™  |
| EcoSPARK®   | ISOPLANAR™               | Saving our world, 1mW/W/KW at a time™   | TinyWire™   |
| EfficientMax™   | MegaBuck™                | SignalWise™   | TriFault Detect™  |
| EZSWITCH™*  | MICROCOUPLER™            | SmartMax™   | TRUECURRENT™*   |
|  ™ | MicroFET™                | SMART START™  | μSerDes™  |
| Fairchild®  | MicroPak™                | SPM®  |  SerDes™             |
| Fairchild Semiconductor®  | MicroPak2™               | STEALTH™  | UHC®  |
| FACT Quiet Series™  | MillerDrive™             | SuperFET™   | Ultra FRFET™  |
| FACT®   | MotionMax™               | SuperSOT™.3   | UniFET™   |
| FAST®   | Motion-SPM™              | SuperSOT™.6   | VCX™  |
| FastvCore™  | OptoHIT™                 | SupreMOS™   | VisualMax™  |
| FETBench™   | OPTOLOGIC®               | SyncFET™  | XST™  |
|   | OPTOPLANAR®              | Sync-Lock™  |   |

\* Trademarks of System General Corporation, used under license by Fairchild Semiconductor.

**DISCLAIMER**

FAIRCHILD SEMICONDUCTOR RESERVES THE RIGHT TO MAKE CHANGES WITHOUT FURTHER NOTICE TO ANY PRODUCTS HEREIN TO IMPROVE RELIABILITY, FUNCTION, OR DESIGN. FAIRCHILD DOES NOT ASSUME ANY LIABILITY ARISING OUT OF THE APPLICATION OR USE OF ANY PRODUCT OR CIRCUIT DESCRIBED HEREIN; NEITHER DOES IT CONVEY ANY LICENSE UNDER ITS PATENT RIGHTS, NOR THE RIGHTS OF OTHERS. THESE SPECIFICATIONS DO NOT EXPAND THE TERMS OF FAIRCHILD'S WORLDWIDE TERMS AND CONDITIONS, SPECIFICALLY THE WARRANTY THEREIN, WHICH COVERS THESE PRODUCTS.

**LIFE SUPPORT POLICY**

FAIRCHILD'S PRODUCTS ARE NOT AUTHORIZED FOR USE AS CRITICAL COMPONENTS IN LIFE SUPPORT DEVICES OR SYSTEMS WITHOUT THE EXPRESS WRITTEN APPROVAL OF FAIRCHILD SEMICONDUCTOR CORPORATION.

As used herein:

1. Life support devices or systems are devices or systems which, (a) are intended for surgical implant into the body or (b) support or sustain life, and (c) whose failure to perform when properly used in accordance with instructions for use provided in the labeling, can be reasonably expected to result in a significant injury of the user.
2. A critical component in any component of a life support, device, or system whose failure to perform can be reasonably expected to cause the failure of the life support device or system, or to affect its safety or effectiveness.

**ANTI-COUNTERFEITING POLICY**

Fairchild Semiconductor Corporation's Anti-Counterfeiting Policy. Fairchild's Anti-Counterfeiting Policy is also stated on our external website, [www.fairchildsemi.com](http://www.fairchildsemi.com), under Sales Support.

Counterfeiting of semiconductor parts is a growing problem in the industry. All manufacturers of semiconductor products are experiencing counterfeiting of their parts. Customers who inadvertently purchase counterfeit parts experience many problems such as loss of brand reputation, substandard performance, failed applications, and increased cost of production and manufacturing delays. Fairchild is taking strong measures to protect ourselves and our customers from the proliferation of counterfeit parts. Fairchild strongly encourages customers to purchase Fairchild parts either directly from Fairchild or from Authorized Fairchild Distributors who are listed by country on our web page cited above. Products customers buy either from Fairchild directly or from Authorized Fairchild Distributors are genuine parts, have full traceability, meet Fairchild's quality standards for handling and storage and provide access to Fairchild's full range of up-to-date technical and product information. Fairchild and our Authorized Distributors will stand behind all warranties and will appropriately address any warranty issues that may arise. Fairchild will not provide any warranty coverage or other assistance for parts bought from Unauthorized Sources. Fairchild is committed to combat this global problem and encourage our customers to do their part in stopping this practice by buying direct or from authorized distributors.

**PRODUCT STATUS DEFINITIONS**

**Definition of Terms**

Datasheet Identification	Product Status	Definition
Advance Information	Formative / In Design	Datasheet contains the design specifications for product development. Specifications may change in any manner without notice.
Preliminary	First Production	Datasheet contains preliminary data; supplementary data will be published at a later date. Fairchild Semiconductor reserves the right to make changes at any time without notice to improve design.
No Identification Needed	Full Production	Datasheet contains final specifications. Fairchild Semiconductor reserves the right to make changes at any time without notice to improve the design.
Obsolete	Not In Production	Datasheet contains specifications on a product that is discontinued by Fairchild Semiconductor. The datasheet is for reference information only.

Rev. I46