

Schematic:

(One of Two)

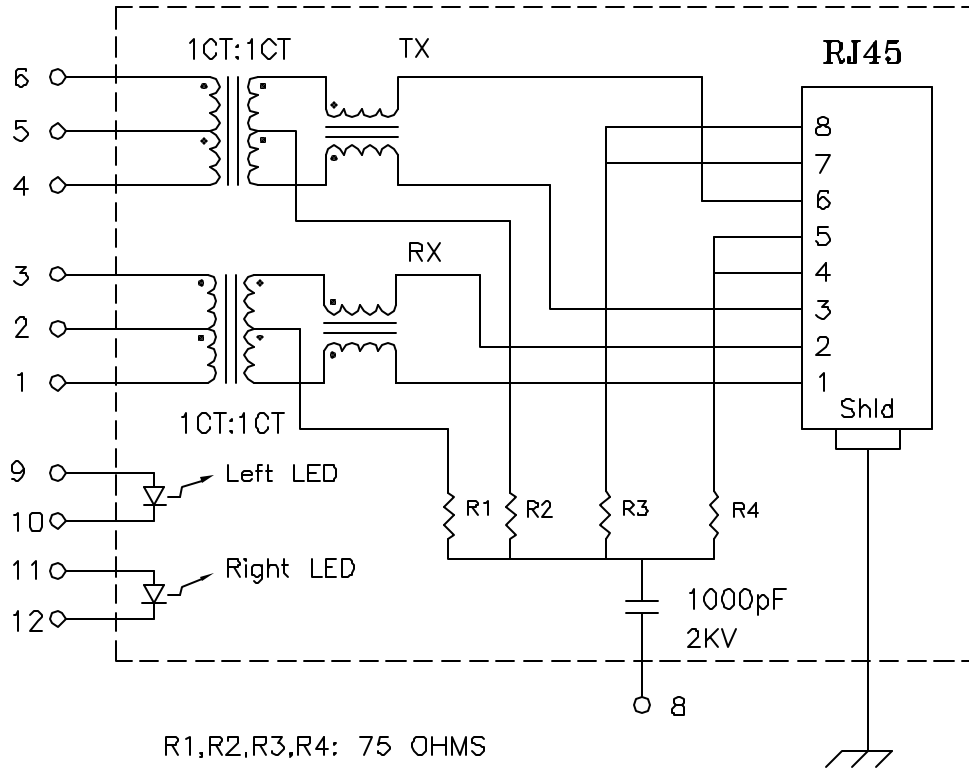

R1,R2,R3,R4: 75 OHMS

Electrical Specifications: @25°C

- Isolation Voltage: 1500 Vrms (Input to Output)
- Isolation Voltage: 500 Vrms (P1+2+3 to P4+5+6)
- Turns Ratio: TX 1CT:1CT ±3% RX 1CT:1CT ±3%
- CABLE SIDE OCL: 350uH Minimum @100KHz 100mV 8mADC
- Cw/w: 27pF Typical @100KHz 100mV
- Insertion Loss (300KHz-100MHz): -1.0dB Minimum
- Return Loss: @30MHz -18dB Minimum
- @80MHz -12dB Minimum

Complete the Combo P/N as follows:

Replace 'x' & 'u' in the part number with one of the LED color letters:

- Y=Yellow
- G=Green
- A=Amber
- R=Red
- N=Yellow(1)/Green(2) Bicolor
- M=Green(1)/Yellow(2) Bicolor
- 'x' = Left LED Color
- 'u' = Right LED Color

Single Color LED:

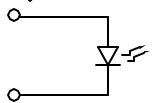

Bi-Color LED:

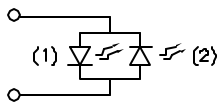

Notes:

1. Solderability: Leads shall meet MIL-STD-202, Method 20BD for solderability.
2. Flammability: UL94V-0
3. ASTM oxygen index: > 28%
4. Temperature rating: 155°C. UL file E151556
5. Operating Temperature Range: -40°C to +85°C

DOC. REV: A/4

XFMRS Inc.	Title: DUAL PORT COMBO		
	UNLESS OTHERWISE SPECIFIED TOLERANCES: .xxx ±0.010	P/N: XFATM9-CLxu2-4MS	REV. A
Dimensions in Inch	DWN. 李小锋	Apr-30-03	
	CHK. 廖玉坤	Apr-30-03	
SHEET 1 OF 2	APP. MS	Apr-30-03	

Mechanical Dimensions: (FOR CLxu2-4MS)

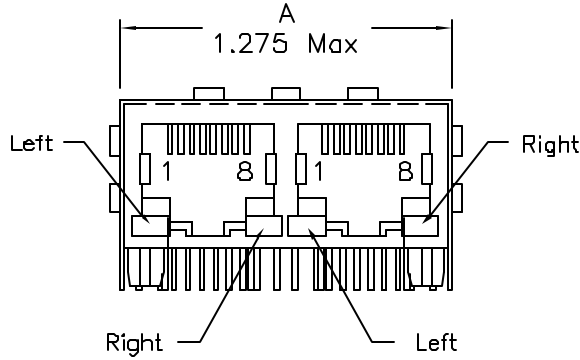

TOP VIEW

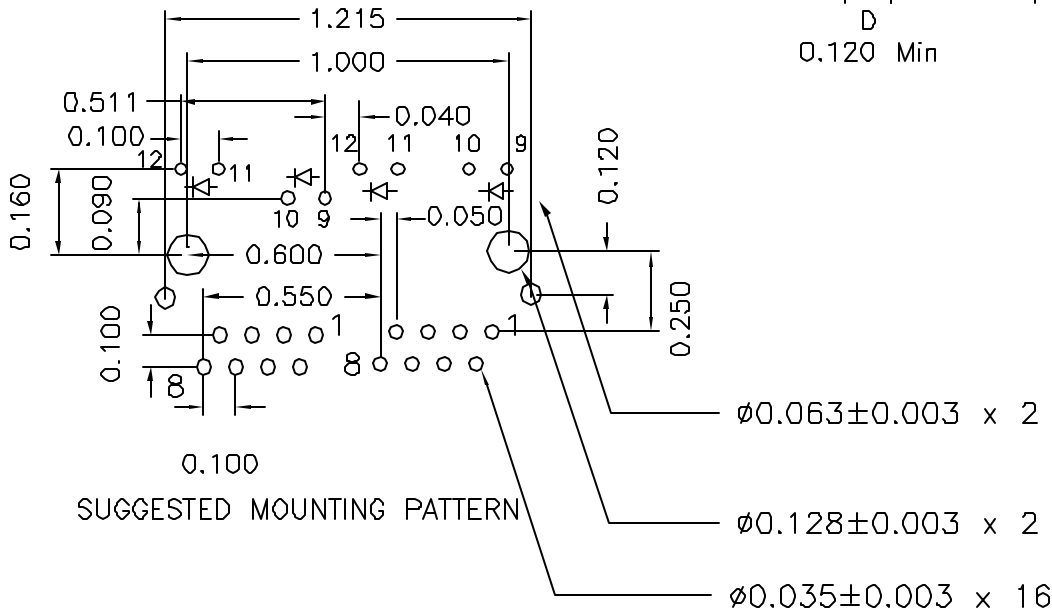
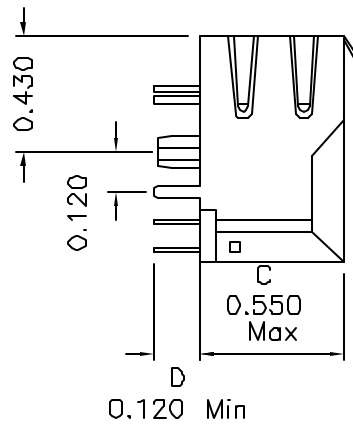
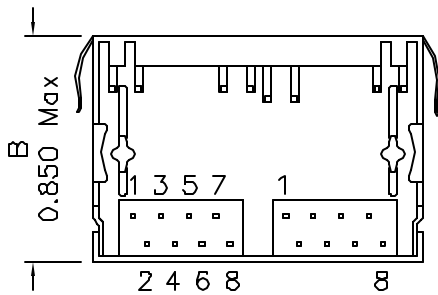

XFMRS Inc.	Title: Mechanical Dimensions For CLxu2-4MS Series		
	UNLESS OTHERWISE SPECIFIED TOLERANCES: .xxx ±0.010 Dimensions in Inch	P/N: XFATM9-CLxu2-4MS	REV. A
DOC REV: A/4	SHEET 2 OF 2	DWN. 李小锋	Apr-30-03
		CHK. 廖玉坤	Apr-30-03
		APP. MS	Apr-30-03