

IB_LD-1W & IB_LS-1W Series

1W, FIXED INPUT, ISOLATED & REGULATED
SINGLE OUTPUT DC-DC CONVERTER

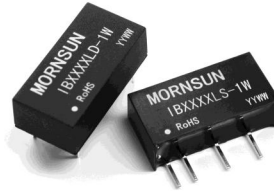

multi-country patent protection **RoHS**

FEATURES

Small Footprint
SIP/DIP Package
Low Ripple and good EMC features
Temperature Range: -40°C to +85°C
No Heat Sink Required
No External Component Required
1KVDC Isolation
Internal SMD construction
Continuous Short Circuit Protection
Industry Standard Pinout
RoHS Compliance

APPLICATIONS

The IB_LD-1W & IB_LS-1W Series are specially designed for applications where a single power supply is highly isolated from the input power supply in a distributed power supply system on a circuit board.

These products apply to:

- 1) Where the voltage of the input power supply is fixed (voltage variation $\leq \pm 5\%$);
- 2) Where isolation is necessary between input and output (isolation voltage $\leq 1000\text{VDC}$);
- 3) Where the regulation of the output voltage and the output ripple and noise are demanded.

MODEL SELECTION

IB0515LS-1W

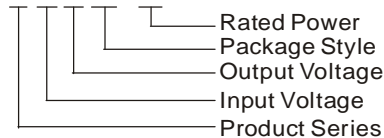

MORNSUN Science& Technology co.,Ltd.

Address: 2th floor 6th building, Hangzhou Industrial District, Guangzhou, China
Tel: 86-20-38601850
Fax: 86-20-38601272
<http://www.mornsun-power.com>

PRODUCT PROGRAM

Part Number	Input		Output			Efficiency (% Typ)	Package		
	Voltage (VDC)		Voltage (VDC)	Current (mA)					
	Nominal	Range		Max	Min				
IB0505LD-W75	5	4.75-5.25	5	150	15	68	DIP		
IB0509LD-1W			9	111	12	70	DIP		
IB0512LD-1W			12	83	9	71	DIP		
IB0515LD-1W			15	67	7	73	DIP		
IB0505LS-W75			5	150	15	68	SIP		
IB0509LS-1W			9	111	12	70	SIP		
IB0512LS-1W			12	83	9	71	SIP		
IB0515LS-1W			15	67	7	73	SIP		
IB1205LD-W75			12	11.4-12.6	5	150	15	68	DIP
IB1209LD-1W	9	111			12	72	DIP		
IB1212LD-1W	12	83			9	70	DIP		
IB1215LD-1W	15	67			7	74	DIP		
IB1205LS-W75	5	150			15	68	SIP		
IB1209LS-1W	9	111			12	72	SIP		
IB1212LS-1W	12	83			9	70	SIP		
IB1215LS-1W	15	67			7	74	SIP		
IB1505LS-W75	15	14.25-15.75			5	150	15	70	SIP
IB1509LS-1W *			9	111	12	71	SIP		
IB1512LS-1W *			12	83	9	71	SIP		
IB1515LS-1W			15	67	7	72	SIP		
IB2405LD-W75*			24	22.8-25.2	5	150	15	68	DIP
IB2409LD-1W					9	111	12	68	DIP
IB2412LD-1W					12	83	9	73	DIP
IB2415LD-1W					15	67	7	75	DIP
IB2405LS-W75					5	150	15	68	SIP
IB2409LS-1W	9	111			12	68	SIP		
IB2412LS-1W	12	83			9	73	SIP		
IB2415LS-1W	15	67			7	75	SIP		

* Designing.

COMMON SPECIFICATION

Item	Test condition	Min	Typ	Max	Units
Storage humidity				95	%
Operating temperature		-40		85	°C
Storage temperature		-55		125	
Temp. rise at full load			15	25	
Lead temperature	1.5mm from case for 10 seconds			300	
Short circuit protection		Continuous			
Cooling		Free air convection			
Case material		Plastic(UL94-V0)			
MTBF		3500			K hours
Weight			2.1		g

ISOLATION SPECIFICATIONS

Item	Test condition	Min	Typ	Max	Units
Isolation voltage	Tested for 1 minute	1000			VDC
Isolation resistance	Test at 500VDC	1000			MΩ

OUTPUT SPECIFICATIONS

Item	Test Conditions	Min	Typ	Max	Units
Output power		0.1		1	W
Line regulation	For Vin change of 5%			±0.25	%
Load regulation	10% to 100% load			±1	
Output voltage accuracy	100% full load			±3	
Temperature drift	100% full load			0.03	%/°C
Ripple*	20MHz Bandwidth		10	20	mVp-p
Noise*	20MHz Bandwidth		50	75	
Switching frequency	Full load, nominal input		100		KHz

*Test ripple and noise by "parallel cable" method. See detailed operation instructions at Testing of Power Converter section, application notes.

Note:

- All specifications measured at TA=25°C, humidity<75%, nominal input voltage and rated output load unless otherwise specified.
- See below recommended circuits for more details.

TYPICAL TEMPERATURE CURVE

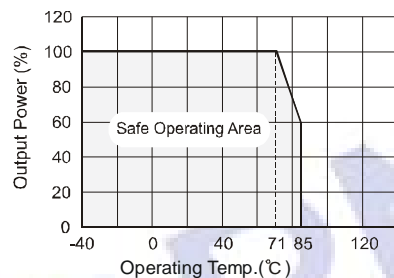

OUTLINE DIMENSION & PIN CONNECTIONS

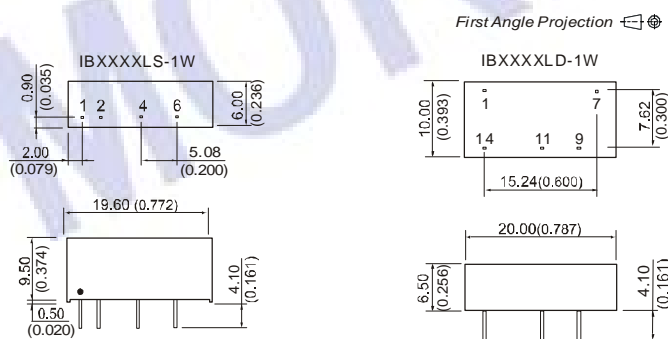

RECOMMENDED FOOTPRINT
Top view, grid: 2.54*2.54mm (0.1*0.1inch),
diameter: 1.00mm (0.039inch)

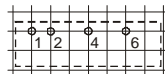

FOOTPRINT DETAILS

Pin	SIP
1	Vin
2	GND
4	0V
6	+Vo

Note:
Unit:mm(inch)
Pin section:0.50*0.30mm(0.020*0.012inch)
Pin section tolerances:±0.10mm(±0.004inch)
General tolerances:±0.25mm(±0.010inch)

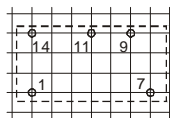

FOOTPRINT DETAILS

Pin	DIP
1	GND
7	NC
9	+Vo
11	0V
14	Vin

NC:No Connection

APPLICATION NOTE

Requirement on output load

To ensure this module can operate efficiently and reliably, During operation, the minimum output load is **not less than 10%** of the full load, and that **this product should never be operated under no load!** If the actual output power is very small, please connect a resistor with proper resistance at the output end in parallel to increase the load, or use our company's products with a lower rated output power (IB_LD -W25/IB_LS-W25 series).

Recommended circuit

If you want to further decrease the input/output ripple, an "LC" filtering network may be connected to the input and output ends of the DC/DC converter, see (Figure 1).

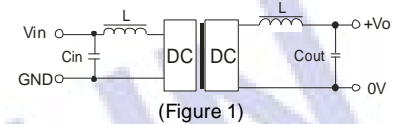

It should also be noted that the inductance and the frequency of the "LC" filtering network should be staggered with the DC/DC frequency to avoid mutual interference. However, the capacitance of the output filter capacitor must be proper. If the capacitance is too big, a startup problem might arise. For every channel of output, provided the safe and reliable operation is ensured, the greatest capacitance of its filter capacitor sees (Table 1).

EXTERNAL CAPACITOR TABLE (TABLE 1)

Vin (VDC)	Cin (uF)	Vout (VDC)	Cout (uF)
5	4.7	5	10
12	4.7	9	4.7
15	2.2	12	2.2
24	1	15	1

It's not recommended to connect any external capacitor in the application field with less than 0.5 watt output.

No parallel connection or plug and play.