



Ferrites and accessories

EP 17

Core and accessories

Series/Type: B65845, B65846

Date: October 2009

- To IEC 61596
- For transformers featuring high inductance and low overall height
- For power applications
- Delivery mode: sets

Magnetic characteristics (per set)

$$\Sigma l/A = 0.84 \text{ mm}^{-1}$$

$$l_e = 28.5 \text{ mm}$$

$$A_e = 33.9 \text{ mm}^2$$

$$A_{\min} = 25.5 \text{ mm}^2$$

$$V_e = 966 \text{ mm}^3$$

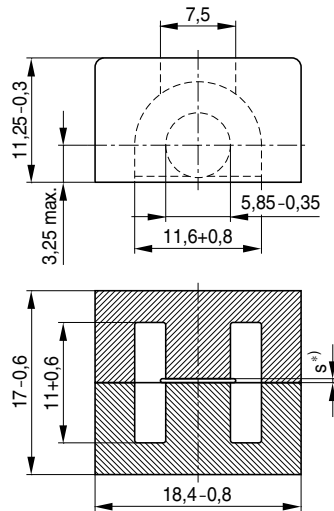
Approx. weight 12 g/set

^{s)} gapped (one-sided)

FEP0027-X

Ungapped

Material	A _L value	μ _e	P _V	Ordering code
	nH		W/set	
N30	4300 +30/-20%	2870		B65845J0000R030
T65	6200 +30/-20%	4150		B65845J0000R065
T38	10800 +40/-30%	7220		B65845J0000Y038
T66	13000 +40/-30%	8700		B65845J0000Y066
N87	2400 +30/-20%	1600	< 0.4 (200 mT, 100 kHz, 100 °C)	B65845J0000R087

Coil former

Material: GFR thermosetting plastic (UL 94 V-0, insulation class to IEC 60085: H $\hat{=}$ max. operating temperature 180 °C), color code black
 Sumikon PM 9630® [E41429 (M)], SUMITOMO BAKELITE CO LTD
 Solderability: to IEC 60068-2-20, test Ta, method 1 (aging 3): 235 °C, 2 s
 Resistance to soldering heat: to IEC 60068-2-20, test Tb, method 1B: 350 °C, 3.5 s
 Winding: see Data Book 2007, chapter "Processing notes, 2.1"
 Squared pins.

Sections	A _N mm ²	I _N mm	A _R value μΩ	Terminals	Ordering code
1	20.3	28.7	48.6	8	B65846W1008D001

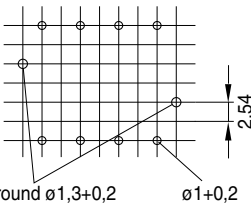
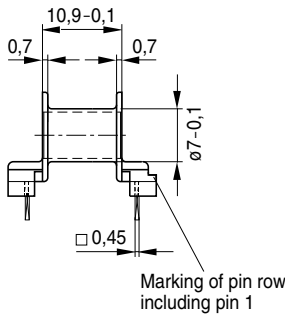
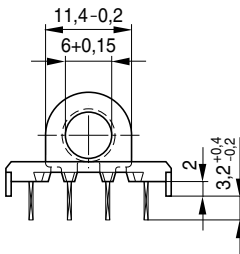
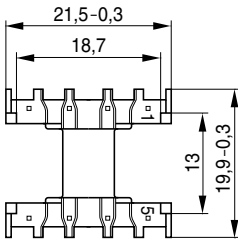

FEP0028-C

Mounting assembly

The set comprises a yoke and a clamp

Yoke

Made of cold rolled steel (0.4 mm) with ground terminal (tinned)

Clamp

Spring clamp, made of bronze (0.4 mm), tinned

	Ordering code
Complete mounting assembly	B65846S2000X000

Yoke

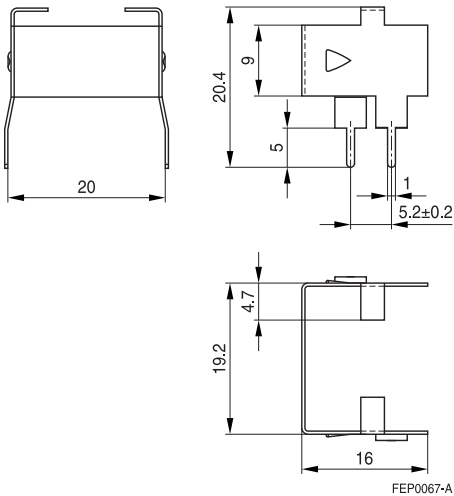

Clamp

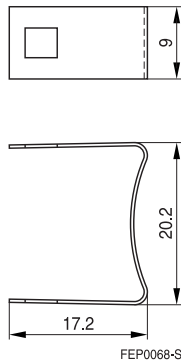

Mechanical stress and mounting

Ferrite cores have to meet mechanical requirements during assembling and for a growing number of applications. Since ferrites are ceramic materials one has to be aware of their special behavior under mechanical load.

Just like any ceramic material, ferrite cores are brittle and sensitive to any shock, fast changing or tensile load. Especially fast cooling rates under ultrasonic cleaning, high static and cyclic loads can cause cracks or failure of the ferrite cores.

For detailed information see Data Book 2007, chapter "General - Definitions, 8.1".

Effects of core combination on A_L value

Stresses in the core affect not only the mechanical but also the magnetic properties. It is apparent that the initial permeability is dependent on the stress state of the core. The higher the stresses are in the core, the lower the value for the initial permeability. Thus, the embedding medium should offer the greatest possible elasticity.

For detailed information see Data Book 2007, chapter "General - Definitions, 8.2".

Heating up

Ferrites can run hot during operation at higher flux densities and higher frequencies.

NiZn-materials

The magnetic properties of NiZn-materials can change irreversibly when exposed to strong magnetic fields.

Processing notes

- The start of the winding process should be soft. Otherwise, the flanges may be destroyed.
- Excessive winding forces may damage the flanges or squeeze the tube so that the cores can no longer be mounted.
- Excessive soldering time at high temperature (>300 °C) may affect coplanarity or pin arrangement.
- Not following the processing notes for soldering of the J-leg terminals may cause solderability problems at the transformer because of contamination with tin oxide (SnO) from the tin bath or burned insulation from the wire. For detailed information see Data Book 2007, chapter "Processing notes, 2.2".
- The dimensions of the pin hole arrangement are fixed and should be understood as an ideal recommendation for drilling the printed circuit board. In order to avoid problems when mounting the transformer, customers should make allowances for manufacturing tolerances in the drilling and pick-and-place processes by increasing the diameter of the pin holes.

Important notes

The following applies to all products named in this publication:

1. Some parts of this publication contain **statements about the suitability of our products for certain areas of application**. These statements are based on our knowledge of typical requirements that are often placed on our products in the areas of application concerned. We nevertheless expressly point out **that such statements cannot be regarded as binding statements about the suitability of our products for a particular customer application**. As a rule, EPCOS is either unfamiliar with individual customer applications or less familiar with them than the customers themselves. For these reasons, it is always ultimately incumbent on the customer to check and decide whether an EPCOS product with the properties described in the product specification is suitable for use in a particular customer application.
2. We also point out that **in individual cases, a malfunction of electronic components or failure before the end of their usual service life cannot be completely ruled out in the current state of the art, even if they are operated as specified**. In customer applications requiring a very high level of operational safety and especially in customer applications in which the malfunction or failure of an electronic component could endanger human life or health (e.g. in accident prevention or life-saving systems), it must therefore be ensured by means of suitable design of the customer application or other action taken by the customer (e.g. installation of protective circuitry or redundancy) that no injury or damage is sustained by third parties in the event of malfunction or failure of an electronic component.
3. **The warnings, cautions and product-specific notes must be observed.**
4. In order to satisfy certain technical requirements, **some of the products described in this publication may contain substances subject to restrictions in certain jurisdictions (e.g. because they are classed as hazardous)**. Useful information on this will be found in our Material Data Sheets on the Internet (www.epcos.com/material). Should you have any more detailed questions, please contact our sales offices.
5. We constantly strive to improve our products. Consequently, **the products described in this publication may change from time to time**. The same is true of the corresponding product specifications. Please check therefore to what extent product descriptions and specifications contained in this publication are still applicable before or when you place an order.

We also **reserve the right to discontinue production and delivery of products**. Consequently, we cannot guarantee that all products named in this publication will always be available. The aforementioned does not apply in the case of individual agreements deviating from the foregoing for customer-specific products.

6. Unless otherwise agreed in individual contracts, **all orders are subject to the current version of the “General Terms of Delivery for Products and Services in the Electrical Industry” published by the German Electrical and Electronics Industry Association (ZVEI)**.
7. The trade names EPCOS, BAOKE, Alu-X, CeraDiode, CSMP, C5SSP, CTVS, D5SSP, MiniBlue, MiniCell, MKK, MLSC, MotorCap, PCC, PhaseCap, PhaseCube, PhaseMod, PhiCap, SIFERRIT, SIFI, SIKOREL, SilverCap, SIMDAD, SIMID, SineFormer, SIOV, SIP5D, SIP5K, ThermoFuse, WindCap are **trademarks registered or pending** in Europe and in other countries. Further information will be found on the Internet at www.epcos.com/trademarks.