

BIPOLAR ANALOG INTEGRATED CIRCUITS

μ PC2709TB

5 V, SUPER MINIMOLD SILICON MMIC MEDIUM OUTPUT POWER AMPLIFIER

DESCRIPTION

The μ PC2709TB is a silicon monolithic integrated circuits designed as 1st IF amplifier for DBS tuners. This IC is packaged in super minimold package which is smaller than conventional minimold.

The μ PC2709TB has compatible pin connections and performance to μ PC2709T of conventional minimold version. So, in the case of reducing your system size, μ PC2709TB is suitable to replace from μ PC2709T.

These IC is manufactured using NEC's 20 GHz μ NESATTMIII silicon bipolar process. This process uses silicon nitride passivation film and gold electrodes. These materials can protect chip surface from external pollution and prevent corrosion/migration. Thus, this IC has excellent performance, uniformity and reliability.

FEATURES

- High-density surface mounting : 6-pin super minimold package (2.0 × 1.25 × 0.9 mm)
- Wideband response : $f_u = 2.3$ GHz TYP. @3 dB bandwidth
- Medium output power : $P_{O(sat)} = +11.5$ dBm@f = 1 GHz with external inductor
- Supply voltage : $V_{CC} = 4.5$ to 5.5 V
- Power gain : $G_P = 23$ dB TYP. @f = 1 GHz
- Port impedance : input/output 50 Ω

APPLICATIONS

- 1st IF amplifiers in DBS converters
- RF stage buffer in DBS tuners, etc.

ORDERING INFORMATION

Part Number	Package	Marking	Supplying Form
μ PC2709TB-E3	6-pin super minimold	C1E	Embossed tape 8 mm wide. 1, 2, 3 pins face the perforation side of the tape. Qty 3 kpcs/reel.

Remark To order evaluation samples, please contact your local NEC sales office (Part number for sample order: μ PC2709TB).

Caution Electro-static sensitive devices

The information in this document is subject to change without notice. Before using this document, please confirm that this is the latest version.
Not all devices/types available in every country. Please check with local NEC representative for availability and additional information.

PIN CONNECTIONS

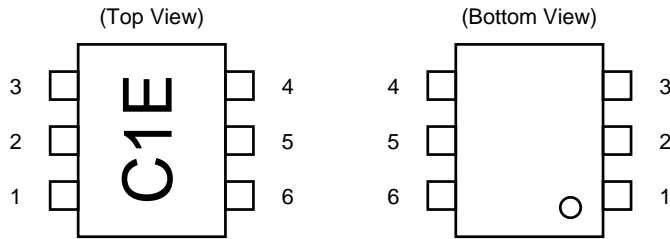

Pin No.	Pin Name
1	INPUT
2	GND
3	GND
4	OUTPUT
5	GND
6	V _{cc}

★ **PRODUCT LINE-UP OF 5 V-BIAS SILICON MMIC MEDIUM OUTPUT POWER AMPLIFIER**

(T_A = +25°C, V_{cc} = V_{out} = 5.0 V, Z_s = Z_L = 50 Ω)

Part No.	f _u (GHz)	P _{O (sat)} (dBm)	G _P (dB)	NF (dB)	I _{cc} (mA)	Package	Marking
μPC2708T	2.9	+10.0	15	6.5 @f = 1 GHz	26	6-pin minimold	C1D
μPC2708TB						6-pin super minimold	
μPC2709T	2.3	+11.5	23	5 @f = 1 GHz	25	6-pin minimold	C1E
μPC2709TB						6-pin super minimold	
μPC2710T	1.0	+13.5	33	3.5 @f = 0.5 GHz	22	6-pin minimold	C1F
μPC2710TB						6-pin super minimold	
μPC2776T	2.7	+8.5	23	6.0 @f = 1 GHz	25	6-pin minimold	C2L
μPC2776TB						6-pin super minimold	

Remark Typical performance. Please refer to ELECTRICAL CHARACTERISTICS in detail.

Caution The package size distinguishes between minimold and super minimold.

SYSTEM APPLICATION EXAMPLE

EXAMPLE OF DBS CONVERTERS

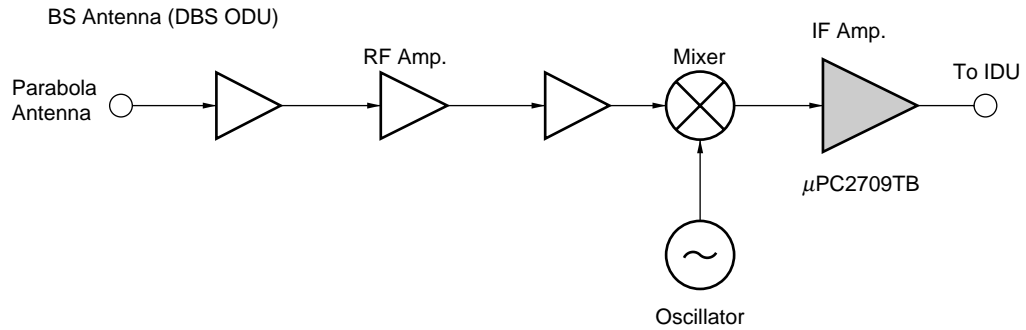

EXAMPLE OF 900 MHz BAND, 1.5 GHz BAND DIGITAL CELLULAR TELEPHONE

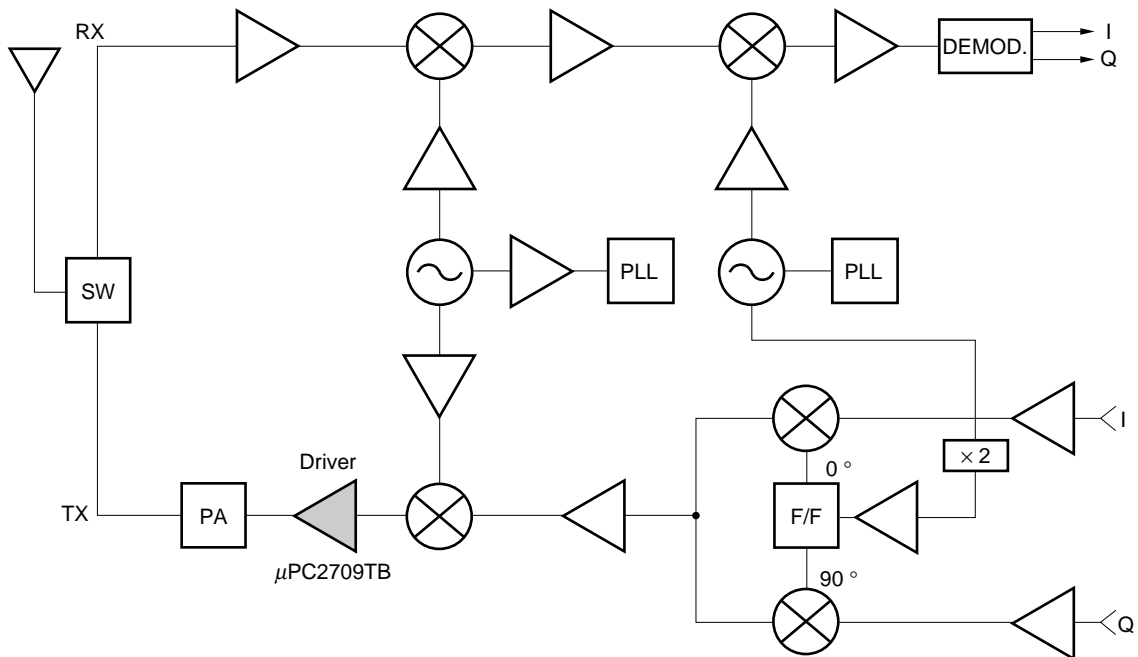

PIN EXPLANATION

Pin No.	Pin Name	Applied Voltage (V)	Pin Voltage (V) ^{Note}	Function and Applications	Internal Equivalent Circuit
1	INPUT	–	1.05	Signal input pin. A internal matching circuit, configured with resistors, enables 50 Ω connection over a wide band. A multi-feedback circuit is designed to cancel the deviations of h _{FE} and resistance. This pin must be coupled to signal source with capacitor for DC cut.	
4	OUTPUT	Voltage as same as V _{cc} through external inductor	–	Signal output pin. The inductor must be attached between V _{cc} and output pins to supply current to the internal output transistors.	
6	V _{cc}	4.5 to 5.5	–	Power supply pin, which biases the internal input transistor. This pin should be externally equipped with bypass capacitor to minimize its impedance.	
2 3 5	GND	0	–	Ground pin. This pin should be connected to system ground with minimum inductance. Ground pattern on the board should be formed as wide as possible. All the ground pins must be connected together with wide ground pattern to decrease impedance deference.	

Note Pin voltage is measured at V_{cc} = 5.0 V

ABSOLUTE MAXIMUM RATINGS

Parameter	Symbol	Conditions	Ratings	Unit
Supply Voltage	V _{CC}	T _A = +25°C, Pin 4 and 6	6	V
Total Circuit Current	I _{CC}	T _A = +25°C	60	mA
Power Dissipation	P _D	Mounted on double copper clad 50 × 50 × 1.6 mm epoxy glass PWB (T _A = +85°C)	270	mW
Operating Ambient Temperature	T _A		-40 to +85	°C
Storage Temperature	T _{stg}		-55 to +150	°C
Input Power	P _{in}	T _A = +25°C	+10	dBm

★

RECOMMENDED OPERATING RANGE

Parameter	Symbol	MIN.	TYP.	MAX.	Unit	Remark
Supply Voltage	V _{CC}	4.5	5.0	5.5	V	The same voltage should be applied to pin 4 and 6.
Operating Ambient Temperature	T _A	-40	+25	+85	°C	

ELECTRICAL CHARACTERISTICS (T_A = +25°C, V_{CC} = V_{out} = 5.0 V, Z_s = Z_L = 50 Ω)

Parameter	Symbol	Test Conditions	MIN.	TYP.	MAX.	Unit
Circuit Current	I _{CC}	No input signal	19	25	32	mA
Power Gain	G _P	f = 1 GHz	21.0	23.0	26.5	dB
Saturated Output Power	P _{O (sat)}	f = 1 GHz, P _{in} = 0 dBm	+9.0	+11.5	-	dBm
Noise Figure	NF	f = 1 GHz	-	5.0	6.5	dB
Upper Limit Operating Frequency	f _u	3 dB down below flat gain at f = 0.1 GHz	2.0	2.3	-	GHz
Isolation	ISL	f = 1 GHz	26	31	-	dB
Input Return Loss	RL _{in}	f = 1 GHz	7	10	-	dB
Output Return Loss	RL _{out}	f = 1 GHz	7	10	-	dB
Gain Flatness	ΔG _P	f = 0.1 to 1.8 GHz	-	±1.0	-	dB

TEST CIRCUIT

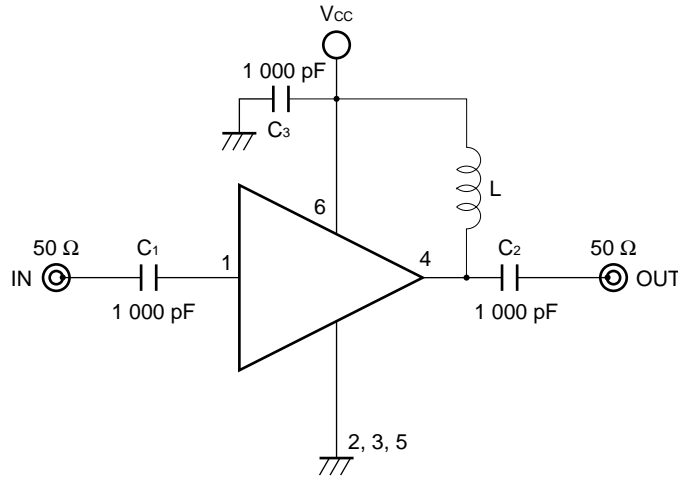

COMPONENTS OF TEST CIRCUIT FOR MEASURING ELECTRICAL CHARACTERISTICS EXAMPLE OF ACTUAL APPLICATION COMPONENTS

	Type	Value
C ₁ to C ₂	Bias Tee	1 000 pF
C ₃	Capacitor	1 000 pF
L	Bias Tee	1 000 nH

	Type	Value	Operating Frequency
C ₁ to C ₃	Chip capacitor	1 000 pF	100 MHz or higher
L	Chip inductor	300 nH	10 MHz or higher
		100 nH	100 MHz or higher
		10 nH	1.0 GHz or higher

INDUCTOR FOR THE OUTPUT PIN

The internal output transistor of this IC consumes 20 mA, to output medium power. To supply current for output transistor, connect an inductor between the Vcc pin (pin 6) and output pin (pin 4). Select large value inductance, as listed above.

The inductor has both DC and AC effects. In terms of DC, the inductor biases the output transistor with minimum voltage drop to output enable high level. In terms of AC, the inductor make output-port impedance higher to get enough gain. In this case, large inductance and Q is suitable.

CAPACITORS FOR THE Vcc, INPUT, AND OUTPUT PINS

Capacitors of 1 000 pF are recommendable as the bypass capacitor for the Vcc pin and the coupling capacitors for the input and output pins.

The bypass capacitor connected to the Vcc pin is used to minimize ground impedance of Vcc pin. So, stable bias can be supplied against Vcc fluctuation.

The coupling capacitors, connected to the input and output pins, are used to cut the DC and minimize RF serial impedance. Their capacitance are therefore selected as lower impedance against a 50 Ω load. The capacitors thus perform as high pass filters, suppressing low frequencies to DC.

To obtain a flat gain from 100 MHz upwards, 1 000 pF capacitors are used in the test circuit. In the case of under 10 MHz operation, increase the value of coupling capacitor such as 10 000 pF. Because the coupling capacitors are determined by equation, $C = 1/(2 \pi Rfc)$.

ILLUSTRATION OF THE TEST CIRCUIT ASSEMBLED ON EVALUATION BOARD

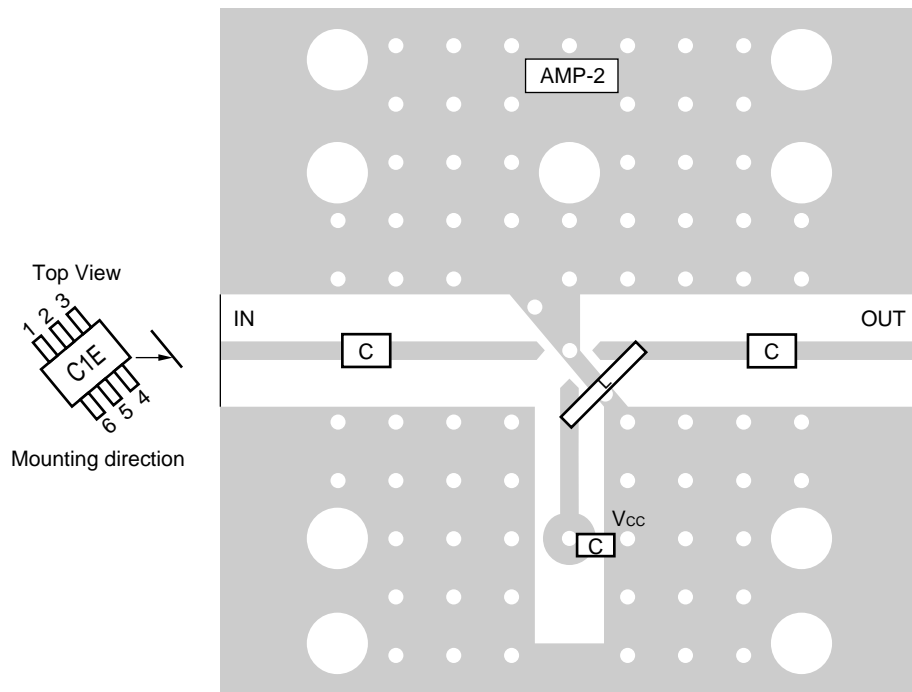

COMPONENT LIST

	Value
C	1 000 pF
L	300 nH

Notes

1. 30 × 30 × 0.4 mm double sided copper clad polyimide board.
2. Back side: GND pattern
3. Solder plated on pattern
4. ○○: Through holes

For more information on the use of this IC, refer to the following application note:

USAGE AND APPLICATION OF SILICON MEDIUM-POWER HIGH-FREQUENCY AMPLIFIER MMIC (P12152E).

TYPICAL CHARACTERISTICS (Unless otherwise specified, $T_A = +25^\circ\text{C}$)

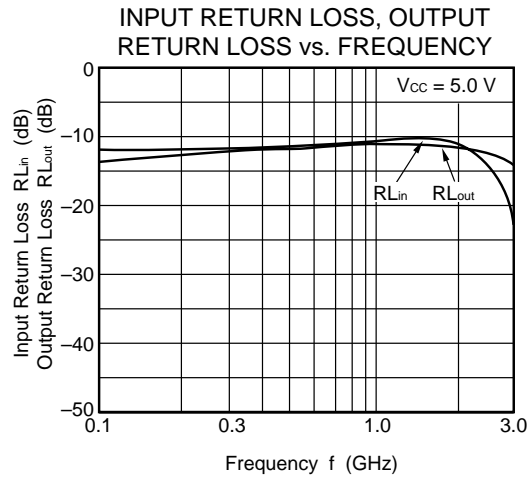
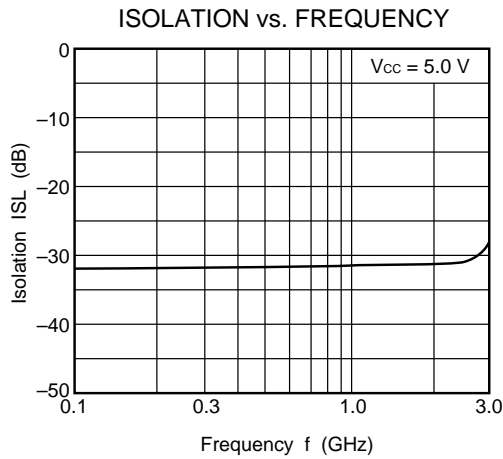
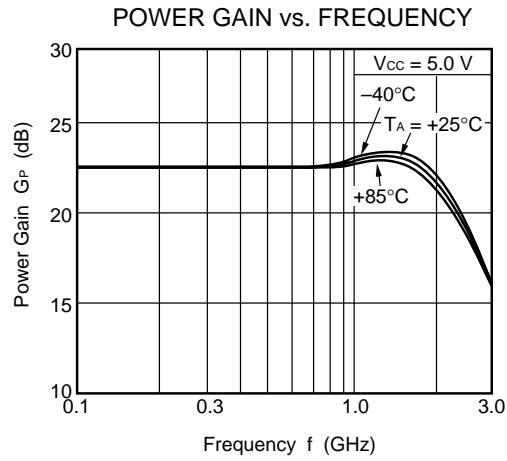
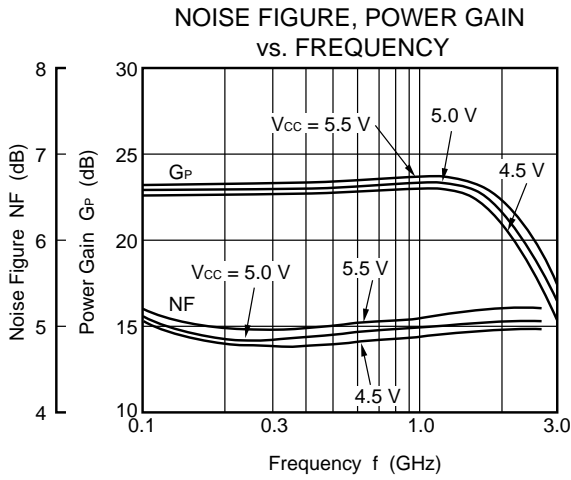
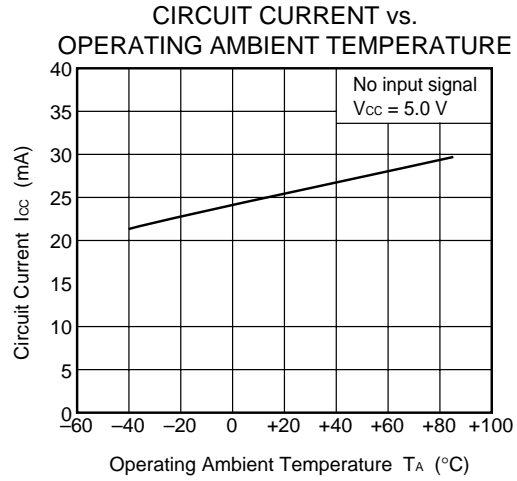
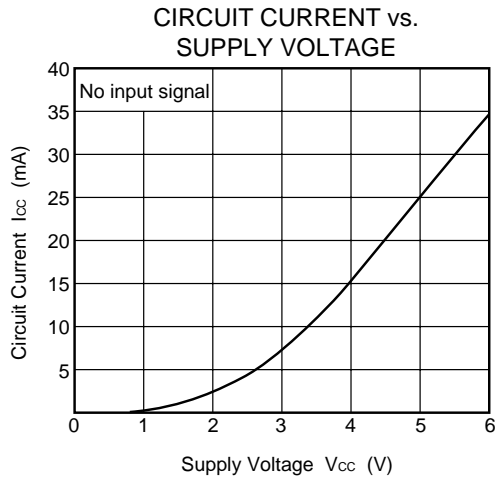

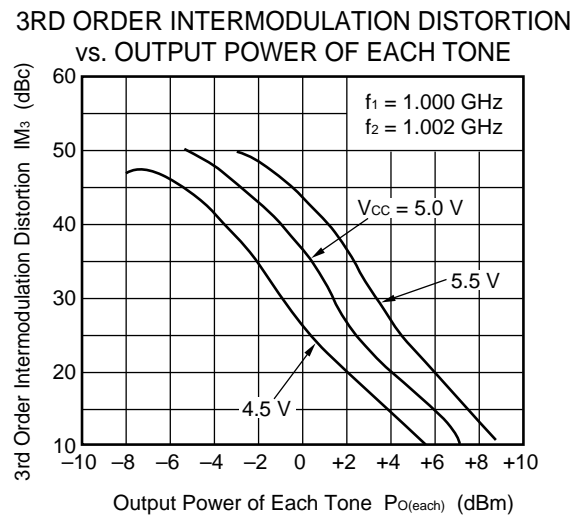
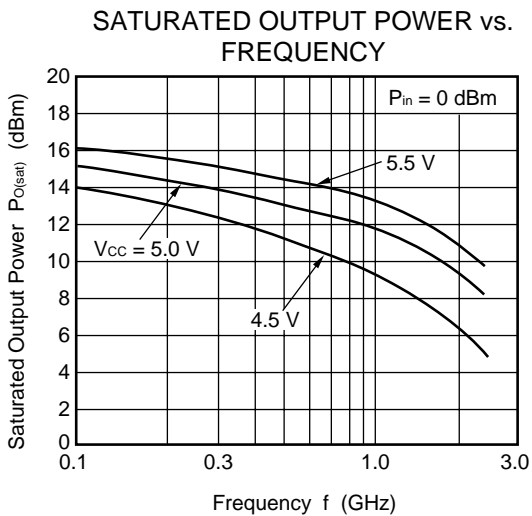
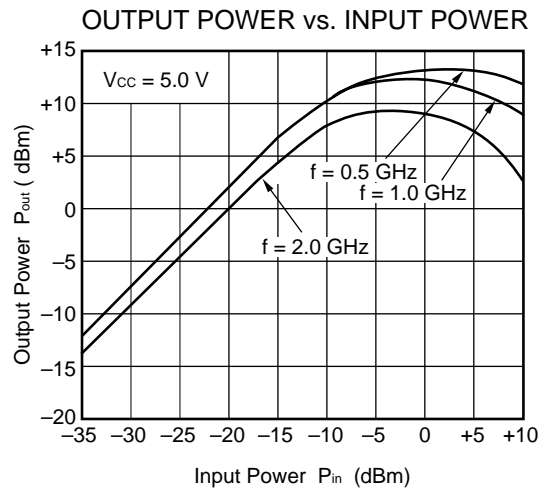
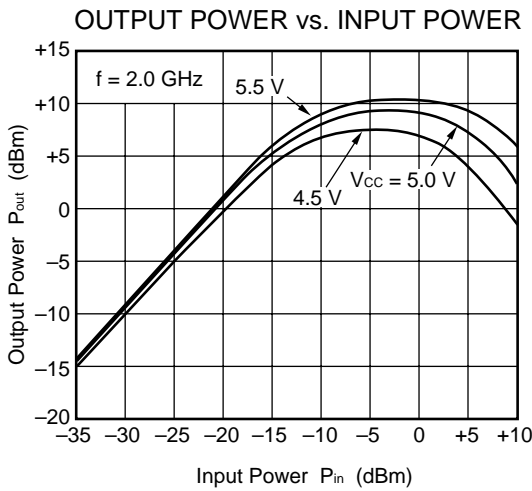
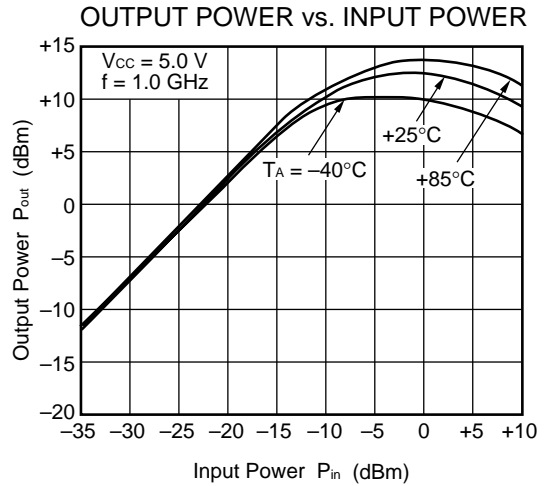
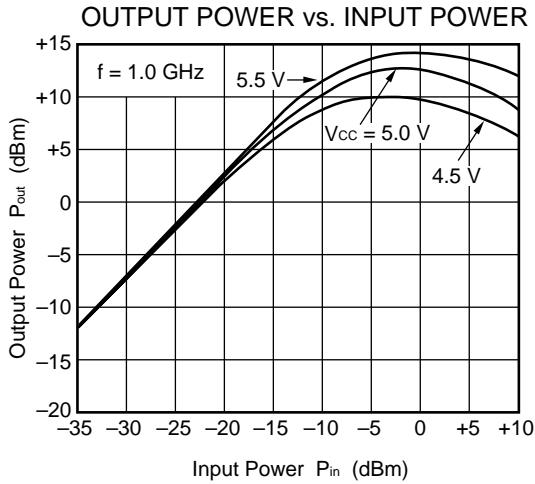

Remark The graphs indicate nominal characteristics.

S-PARAMETERS ($T_A = +25^\circ\text{C}$, $V_{CC} = V_{out} = 5.0\text{ V}$)

S₁₁-FREQUENCY

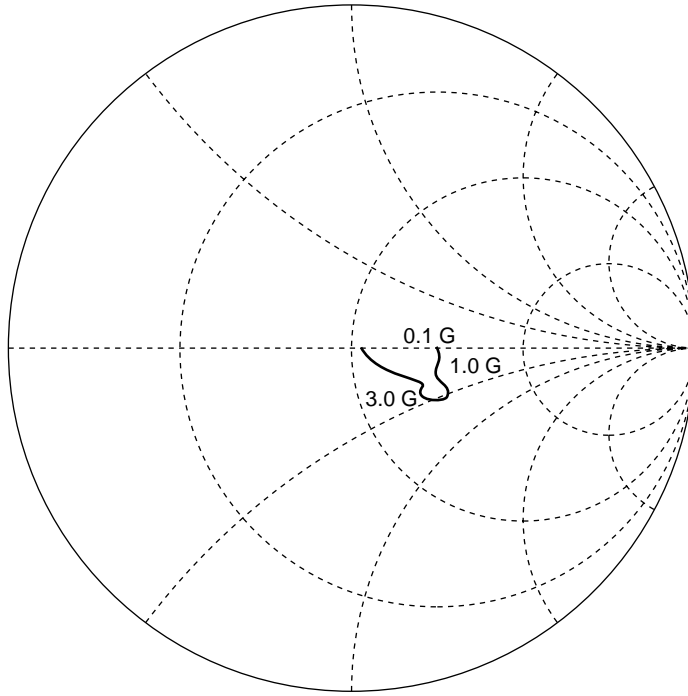

S₂₂-FREQUENCY

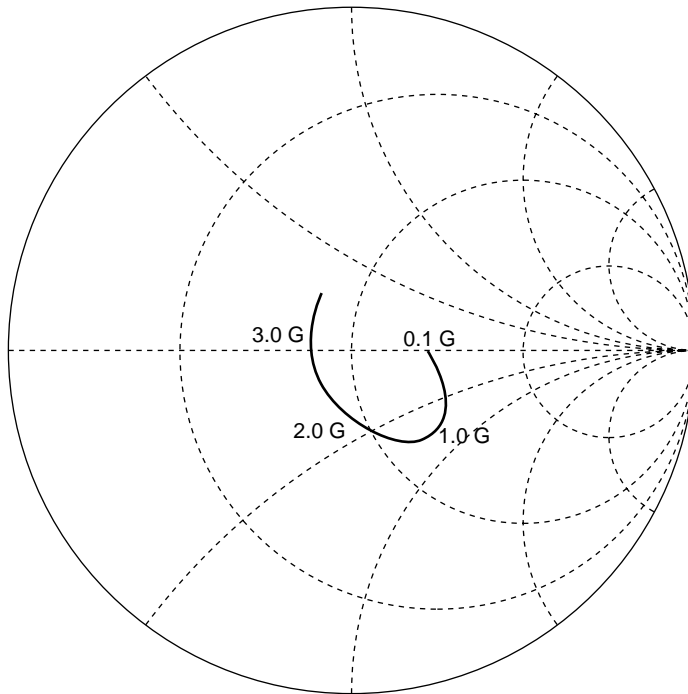

TYPICAL S-PARAMETER VALUES (T_A = +25°C)

V_{CC} = V_{out} = 5.0 V, I_{CC} = 26 mA

Frequency MHz	S ₁₁		S ₂₁		S ₁₂		S ₂₂		K
	MAG.	ANG.	MAG.	ANG.	MAG.	ANG.	MAG.	ANG.	
100.0000	0.227	0.2	13.698	-4.5	0.027	-1.0	0.196	0.9	1.37
200.0000	0.239	1.0	13.724	-9.6	0.027	3.1	0.207	2.2	1.36
300.0000	0.245	2.9	13.830	-14.5	0.026	4.7	0.212	4.1	1.38
400.0000	0.244	2.5	13.998	-19.9	0.027	7.8	0.223	3.4	1.32
500.0000	0.243	1.5	14.109	-25.0	0.026	9.8	0.234	2.1	1.33
600.0000	0.247	-1.5	14.246	-30.4	0.027	11.9	0.252	-0.4	1.26
700.0000	0.265	-3.2	14.538	-35.5	0.028	13.6	0.270	-2.3	1.20
800.0000	0.284	-3.6	14.703	-41.3	0.028	14.9	0.287	-4.6	1.15
900.0000	0.301	-3.3	15.051	-47.0	0.028	17.2	0.298	-7.4	1.10
1000.0000	0.305	-2.4	15.331	-53.5	0.029	18.8	0.309	-11.9	1.05
1100.0000	0.299	-3.2	15.605	-60.0	0.029	20.9	0.322	-17.1	1.04
1200.0000	0.300	-6.3	15.773	-66.7	0.029	22.5	0.336	-21.5	1.01
1300.0000	0.314	-10.3	16.152	-74.0	0.030	23.8	0.353	-24.8	0.95
1400.0000	0.328	-14.4	16.282	-81.0	0.030	26.1	0.353	-28.8	0.93
1500.0000	0.354	-17.3	16.337	-89.3	0.032	25.6	0.368	-35.5	0.86
1600.0000	0.359	-19.5	16.370	-96.5	0.031	26.8	0.370	-41.8	0.86
1700.0000	0.373	-22.1	16.256	-104.5	0.033	28.0	0.382	-46.9	0.81
1800.0000	0.371	-26.8	15.977	-112.7	0.032	29.3	0.381	-52.8	0.83
1900.0000	0.379	-31.1	15.529	-120.5	0.033	31.3	0.378	-57.8	0.83
2000.0000	0.386	-36.0	15.307	-128.1	0.034	31.0	0.373	-64.1	0.82
2100.0000	0.387	-39.5	14.745	-135.9	0.033	32.2	0.366	-70.8	0.85
2200.0000	0.374	-43.8	14.212	-143.7	0.033	30.5	0.363	-78.1	0.90
2300.0000	0.360	-48.7	13.633	-151.3	0.033	33.9	0.353	-83.0	0.94
2400.0000	0.339	-55.4	12.846	-158.7	0.032	35.5	0.331	-90.0	1.06
2500.0000	0.338	-62.0	11.990	-165.5	0.033	38.0	0.318	-95.6	1.11
2600.0000	0.334	-66.0	11.265	-172.1	0.033	39.1	0.304	-102.5	1.20
2700.0000	0.330	-69.0	10.560	-177.8	0.033	40.8	0.295	-108.3	1.25
2800.0000	0.311	-69.9	9.942	176.2	0.033	43.5	0.282	-113.7	1.36
2900.0000	0.291	-72.5	9.432	171.3	0.035	44.9	0.267	-118.6	1.40
3000.0000	0.258	-76.5	8.818	166.5	0.035	47.4	0.246	-125.1	1.55
3100.0000	0.240	-80.6	8.353	161.9	0.035	53.4	0.225	-131.2	1.64

★ PACKAGE DIMENSIONS

6-PIN SUPER MINIMOLD (UNIT: mm)

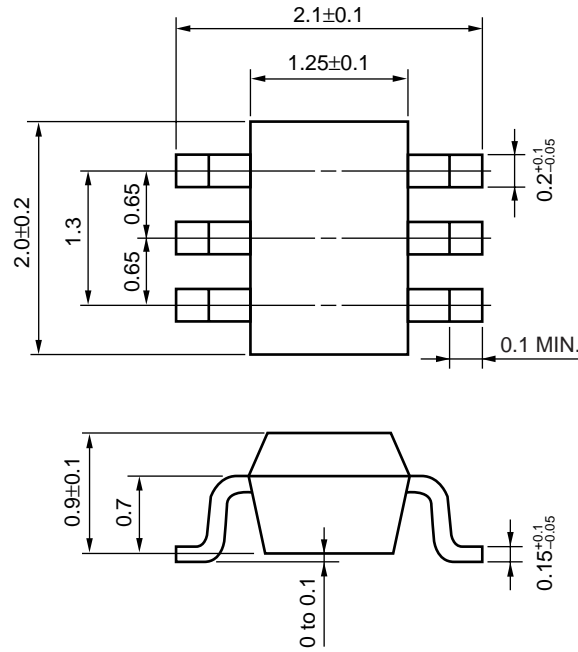

NOTES ON CORRECT USE

- (1) Observe precautions for handling because of electro-static sensitive devices.
- (2) Form a ground pattern as widely as possible to minimize ground impedance (to prevent undesired oscillation).
All the ground pins must be connected together with wide ground pattern to decrease impedance difference.
- (3) The bypass capacitor should be attached to the V_{CC} pin.
- (4) The inductor (L) must be attached between V_{CC} and output pins. The inductance value should be determined in accordance with desired frequency.
- (5) The DC cut capacitor must be attached to input and output pin.

RECOMMENDED SOLDERING CONDITIONS

This product should be soldered under the following recommended conditions. For soldering methods and conditions other than those recommended below, contact your NEC sales representative.

Soldering Method	Soldering Conditions	Recommended Condition Symbol
Infrared Reflow	Package peak temperature: 235°C or below Time: 30 seconds or less (at 210°C) Count: 3, Exposure limit: None ^{Note}	IR35-00-3
VPS	Package peak temperature: 215°C or below Time: 40 seconds or less (at 200°C) Count: 3, Exposure limit: None ^{Note}	VP15-00-3
Wave Soldering	Soldering bath temperature: 260°C or below Time: 10 seconds or less Count: 1, Exposure limit: None ^{Note}	WS60-00-1
Partial Heating	Pin temperature: 300°C Time: 3 seconds or less (per side of device) Exposure limit: None ^{Note}	—

Note After opening the dry pack, keep it in a place below 25°C and 65% RH for the allowable storage period.

Caution Do not use different soldering methods together (except for partial heating).

For details of recommended soldering conditions for surface mounting, refer to information document **SEMICONDUCTOR DEVICE MOUNTING TECHNOLOGY MANUAL (C10535E)**.

[MEMO]

[MEMO]

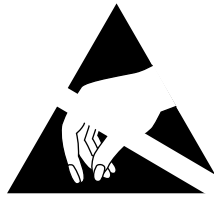

ATTENTION

OBSERVE PRECAUTIONS
FOR HANDLING
ELECTROSTATIC
SENSITIVE
DEVICES

NESAT (NEC Silicon Advanced Technology) is a trademark of NEC Corporation.

- **The information in this document is current as of November, 2000. The information is subject to change without notice. For actual design-in, refer to the latest publications of NEC's data sheets or data books, etc., for the most up-to-date specifications of NEC semiconductor products. Not all products and/or types are available in every country. Please check with an NEC sales representative for availability and additional information.**
- No part of this document may be copied or reproduced in any form or by any means without prior written consent of NEC. NEC assumes no responsibility for any errors that may appear in this document.
- NEC does not assume any liability for infringement of patents, copyrights or other intellectual property rights of third parties by or arising from the use of NEC semiconductor products listed in this document or any other liability arising from the use of such products. No license, express, implied or otherwise, is granted under any patents, copyrights or other intellectual property rights of NEC or others.
- Descriptions of circuits, software and other related information in this document are provided for illustrative purposes in semiconductor product operation and application examples. The incorporation of these circuits, software and information in the design of customer's equipment shall be done under the full responsibility of customer. NEC assumes no responsibility for any losses incurred by customers or third parties arising from the use of these circuits, software and information.
- While NEC endeavours to enhance the quality, reliability and safety of NEC semiconductor products, customers agree and acknowledge that the possibility of defects thereof cannot be eliminated entirely. To minimize risks of damage to property or injury (including death) to persons arising from defects in NEC semiconductor products, customers must incorporate sufficient safety measures in their design, such as redundancy, fire-containment, and anti-failure features.
- NEC semiconductor products are classified into the following three quality grades:
"Standard", "Special" and "Specific". The "Specific" quality grade applies only to semiconductor products developed based on a customer-designated "quality assurance program" for a specific application. The recommended applications of a semiconductor product depend on its quality grade, as indicated below. Customers must check the quality grade of each semiconductor product before using it in a particular application.
 - "Standard": Computers, office equipment, communications equipment, test and measurement equipment, audio and visual equipment, home electronic appliances, machine tools, personal electronic equipment and industrial robots
 - "Special": Transportation equipment (automobiles, trains, ships, etc.), traffic control systems, anti-disaster systems, anti-crime systems, safety equipment and medical equipment (not specifically designed for life support)
 - "Specific": Aircraft, aerospace equipment, submersible repeaters, nuclear reactor control systems, life support systems and medical equipment for life support, etc.

The quality grade of NEC semiconductor products is "Standard" unless otherwise expressly specified in NEC's data sheets or data books, etc. If customers wish to use NEC semiconductor products in applications not intended by NEC, they must contact an NEC sales representative in advance to determine NEC's willingness to support a given application.

(Note)

- (1) "NEC" as used in this statement means NEC Corporation and also includes its majority-owned subsidiaries.
- (2) "NEC semiconductor products" means any semiconductor product developed or manufactured by or for NEC (as defined above).