

Features

- N-channel enhancement mode device
- DMOS structure
- Lower capacitances for broadband operation
- Common source configuration
- Lower noise floor

ABSOLUTE MAXIMUM RATINGS AT 25° C

Parameter	Symbol	Rating	Units
Drain-Source Voltage	V_{DS}	65	V
Gate-Source Voltage	V_{GS}	20	V
Drain-Source Current	I_{DS}	2.8	A
Power Dissipation	P_D	53	W
Junction Temperature	T_J	200	°C
Storage Temperature	T_{STG}	-55 to 150	°C
Thermal Resistance	θ_{JC}	3.3	°C/W

TYPICAL DEVICE IMPEDANCES

F (MHz)	Z_{IN} (Ω)	Z_{LOAD} (Ω)
100	9.5-j60.0	4.0+j68.0
300	5.0-j35.0	40.0+j48.0
500	2.0-j22.0	36.0+j34.0
$V_{DD}=28V, I_{DQ}=200\text{ mA}, P_{OUT}=20.0\text{ W}$		

Z_{IN} is the series equivalent input impedance of the device from gate to source.

Z_{LOAD} is the optimum series equivalent load impedance as measured from drain to ground.

ELECTRICAL CHARACTERISTICS AT 25°C

Parameter	Symbol	Min	Max	Units	Test Conditions
Drain-Source Breakdown Voltage	BV_{DSS}	65	-	V	$V_{GS} = 0.0\text{ V}, I_{DS} = 4.0\text{ mA}$
Drain-Source Leakage Current	I_{DSS}	-	2.0	mA	$V_{DS} = 28.0\text{ V}, V_{GS} = 0.0\text{ V}$
Gate-Source Leakage Current	I_{GSS}	-	2.0	μA	$V_{GS} = 20.0\text{ V}, V_{DS} = 0.0\text{ V}$
Gate Threshold Voltage	$V_{GS(TH)}$	2.0	6.0	V	$V_{DS} = 10.0\text{ V}, I_{DS} = 200.0\text{ mA}$
Forward Transconductance	G_M	.160	-	S	$V_{DS} = 10.0\text{ V}, I_{DS} = 200.0\text{ mA}, \Delta V_{GS} = 1.0V, 80\ \mu\text{s Pulse}$
Input Capacitance	C_{ISS}	-	14	pF	$V_{DS} = 28.0\text{ V}, F = 1.0\text{ MHz}$
Output Capacitance	C_{OSS}	-	10	pF	$V_{DS} = 28.0\text{ V}, F = 1.0\text{ MHz}$
Reverse Capacitance	C_{RSS}	-	4.8	pF	$V_{DS} = 28.0\text{ V}, F = 1.0\text{ MHz}$
Power Gain	G_P	10	-	dB	$V_{DD} = 28.0\text{ V}, I_{DQ} = 200.0\text{ mA}, P_{OUT} = 20.0\text{ W } F = 500\text{ MHz}$
Drain Efficiency	η_D	50	-	%	$V_{DD} = 28.0\text{ V}, I_{DQ} = 200.0\text{ mA}, P_{OUT} = 20.0\text{ W } F = 500\text{ MHz}$
Load Mismatch Tolerance	VSWR-T	-	20:1	-	$V_{DD} = 28.0\text{ V}, I_{DQ} = 200.0\text{ mA}, P_{OUT} = 20.0\text{ W } F = 500\text{ MHz}$

Package Outline

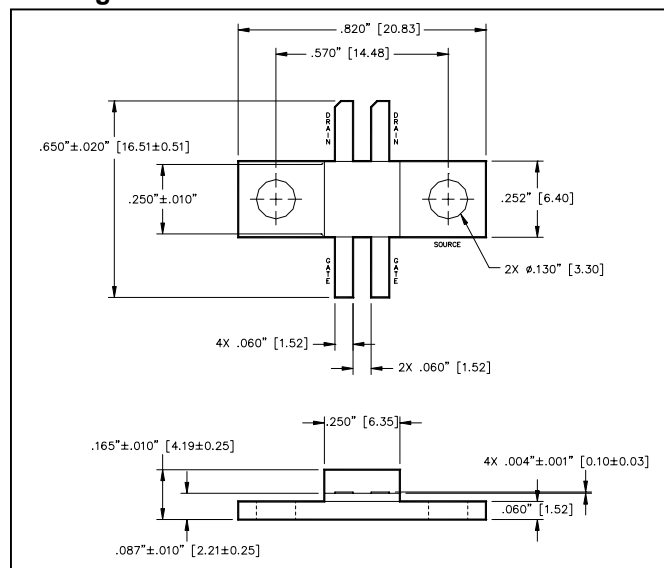

UNLESS OTHERWISE NOTED, TOLERANCES ARE INCHES $\pm .005$ " [MILLIMETERS $\pm 0.13\text{mm}$]

Typical Broadband Performance Curves

CAPACITANCES vs VOLTAGE
 $F=1.0\text{MHz}$

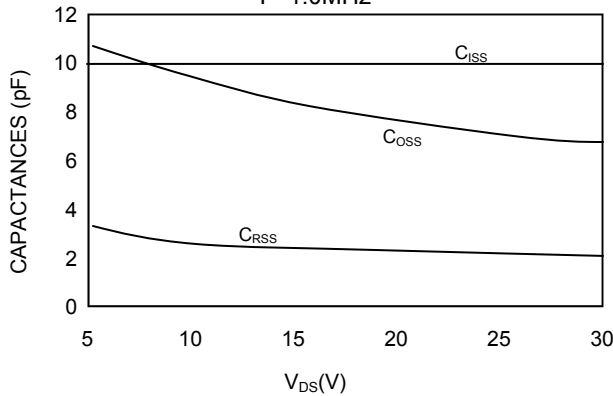

POWER OUTPUT vs VOLTAGE
 $P_{IN}=1.0\text{ W } I_{DQ}=200\text{ mA } P_{OUT}=500\text{ W}$

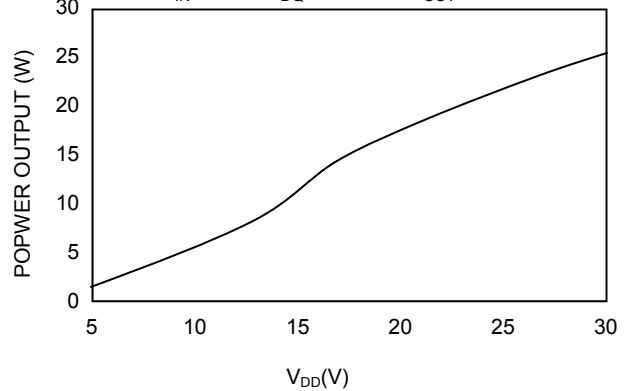

GAIN vs FREQUENCY

$V_{DD}=28\text{ V } P_{OUT}=20\text{ W } I_{DQ}=200\text{ mA}$

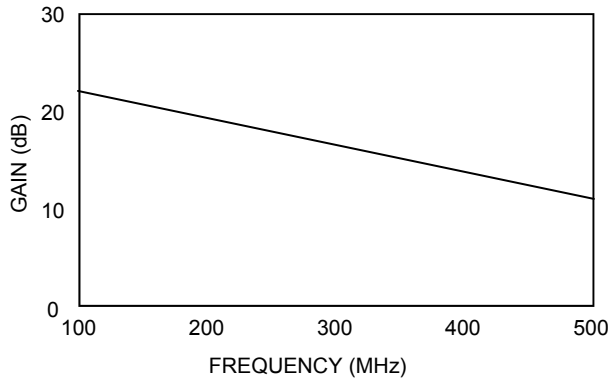

EFFICIENCY vs FREQUENCY

$I_{DQ}=200\text{ mA } P_{OUT}=20\text{ W } F=500\text{ MHz}$

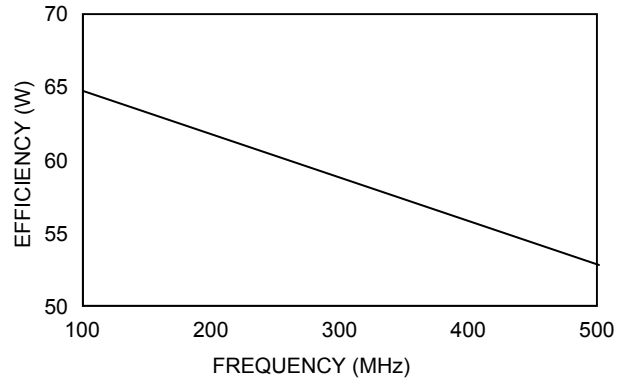

POWER OUTPUT vs POWER INPUT

$V_{DD}=28\text{ V } I_{DQ}=150\text{ mA}$

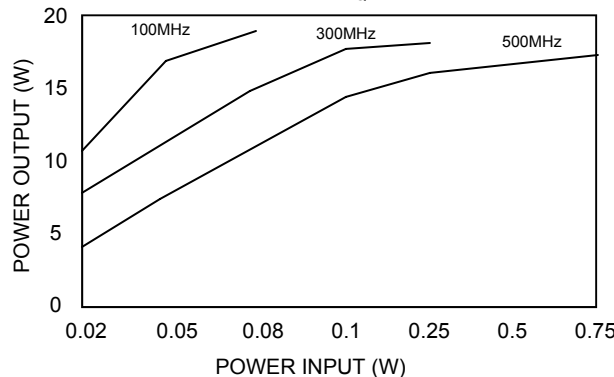

TEST FIXTURE SCHEMATIC

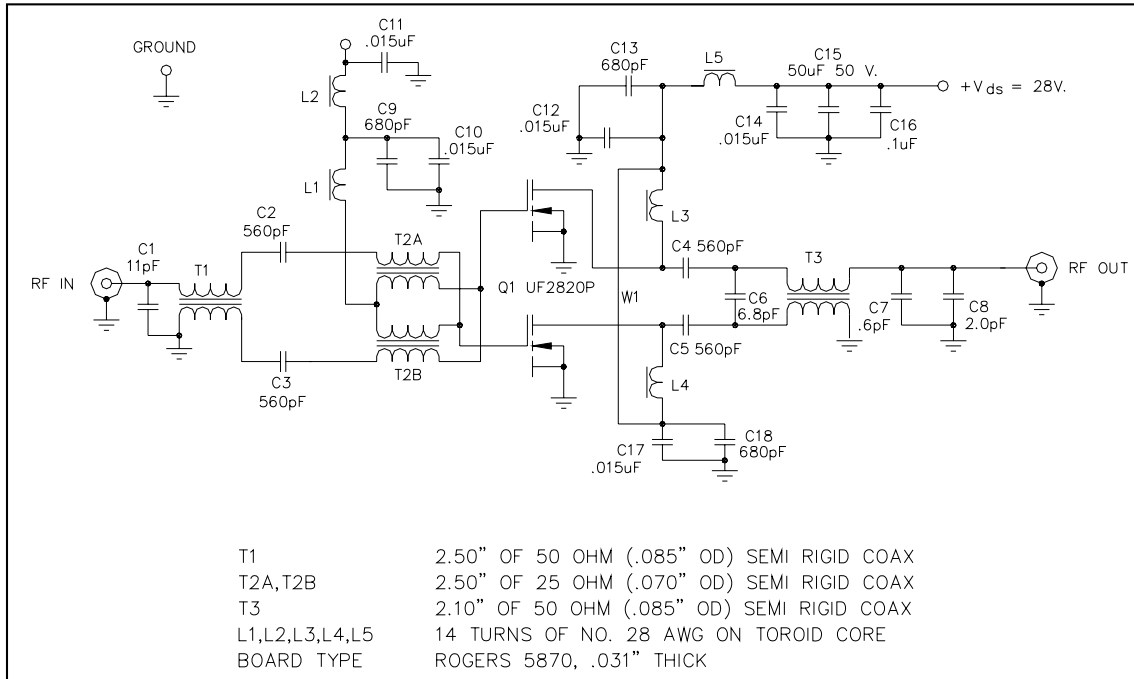

TEST FIXTURE ASSEMBLY

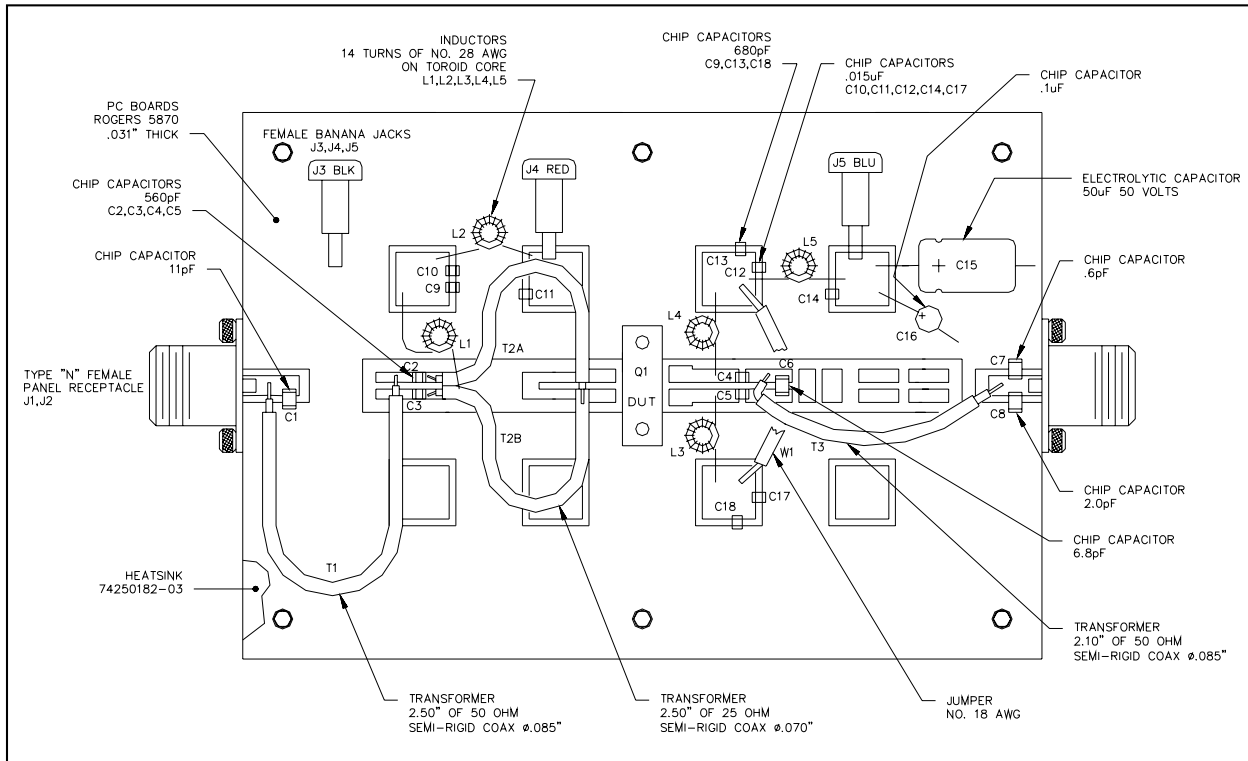

ADVANCED: Data Sheets contain information regarding a product M/A-COM Technology Solutions is considering for development. Performance is based on target specifications, simulated results, and/or prototype measurements. Commitment to develop is not guaranteed.
PRELIMINARY: Data Sheets contain information regarding a product M/A-COM Technology Solutions has under development. Performance is based on engineering tests. Specifications are typical. Mechanical outline has been fixed. Engineering samples and/or test data may be available. Commitment to produce in volume is not guaranteed.

- **North America** Tel: 800.366.2266 / Fax: 978.366.2266
- **Europe** Tel: 44.1908.574.200 / Fax: 44.1908.574.300
- **Asia/Pacific** Tel: 81.44.844.8296 / Fax: 81.44.844.8298

Visit www.macomtech.com for additional data sheets and product information.

M/A-COM Technology Solutions Inc. and its affiliates reserve the right to make changes to the product(s) or information contained herein without notice.