



TAI-SAW TECHNOLOGY CO., LTD.

No. 3, Industrial 2nd Rd., Ping-Chen Industrial District,
Taoyuan, 324, Taiwan, R.O.C.

TEL: 886-3-4690038 FAX: 886-3-4697532

E-mail: tstsales@mail.taisaw.com Web: www.taisaw.com

Approval Sheet For Product Specification

Issued Date:

Product Name: SAW IF Filter 240MHz

TST Parts No.: TB0341A (package 7mm x 5 mm)

Customer Parts No.: _____

Company: _____
Division: _____
Approved by : _____
Date: _____

Checked by: _____ Andy Yu

Approval by: _____ Francis Chen

Date: _____ 12/01 /2006



TAI-SAW TECHNOLOGY CO., LTD.

No.3, Industrial 2nd Rd., Ping-Chen Industrial District,
Taoyuan, Taiwan, R.O.C.

TEL: 886-3-4690038 FAX: 886-3-4697532

E-mail: tstsales3@mail.taisaw.com Web: www.taisaw.com

SAW Filter 240MHz (SMD 7×5 mm)

MODEL NO.: TB0341A

Rev. No. 3

A. MAXIMUM RATING:

1. Input Power Level: 10 dBm
2. Operate Temperature: -40°C to 85°C
3. Storage Temperature: -40°C to 85°C

RoHS Compliant
Lead free
Lead-free soldering

B. ELECTRICAL CHARACTERISTICS:

Item	Unit	Min.	Typ.	Max.
Center frequency, F_c	MHz	239.5	240	240.5
Minimum Insertion Loss, IL	dB	-	10	14
1dB Bandwidth	MHz	5.0	6.0	-
3dB Bandwidth	MHz	-	6.8	7.2
40 dB Bandwidth	MHz	-	10.4	13
Group Delay ripple (237.5-242.5MHz)	nS	-	50	200
Amplitude ripple (237.5-242.5MHz)	dB	-	0.5	1
Phase linearity (237.5-242.5MHz)	rms	-	3	-
Attenuation:(Reference level from Min IL)				
10~234MHz	dB	43	52	-
250MHz~440MHz	dB	40	48	-

C. TEST Circuit:

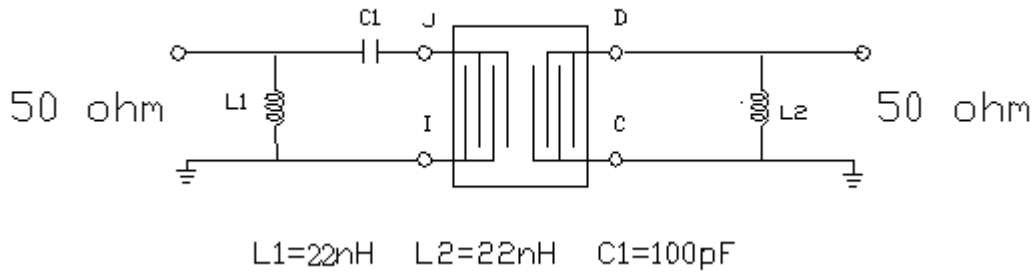

D. OUTLINE DRAWING:

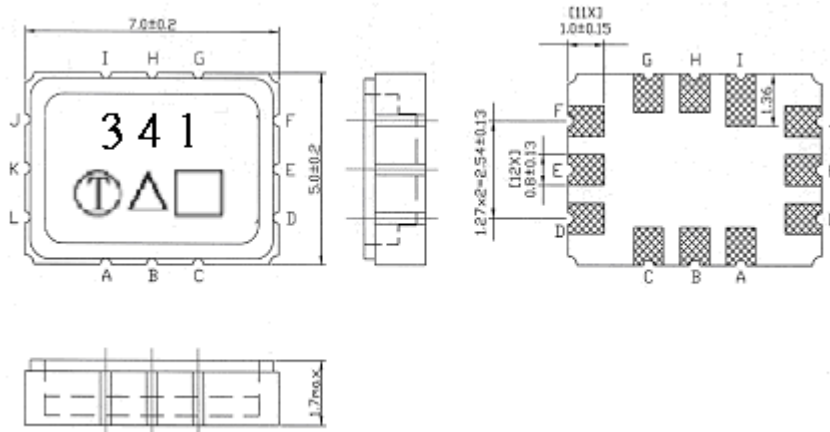

- Pin D : Unbalanced Input
- Pin J : Unbalanced Output
- Pin A, B, C, E, F, G, H, I, K, L : To be Ground
- : date code
- Unit : mm
- △ : Product / Year Code

Year	2005 2009	2006 2010	2007 2011	2008 2012
Product Code	B	b	<u>B</u>	<u>b</u>

E. PCB FOOTPRINT:

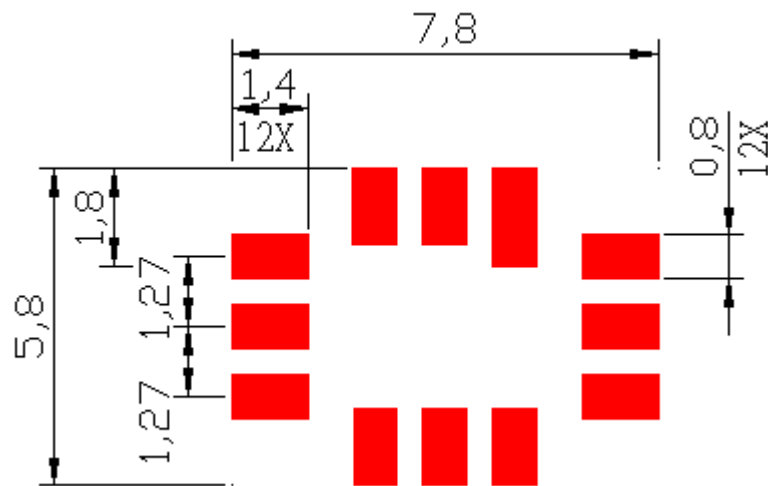

F.FREQUENCY CHARACTERISTICS:

(1) wide band of Response:

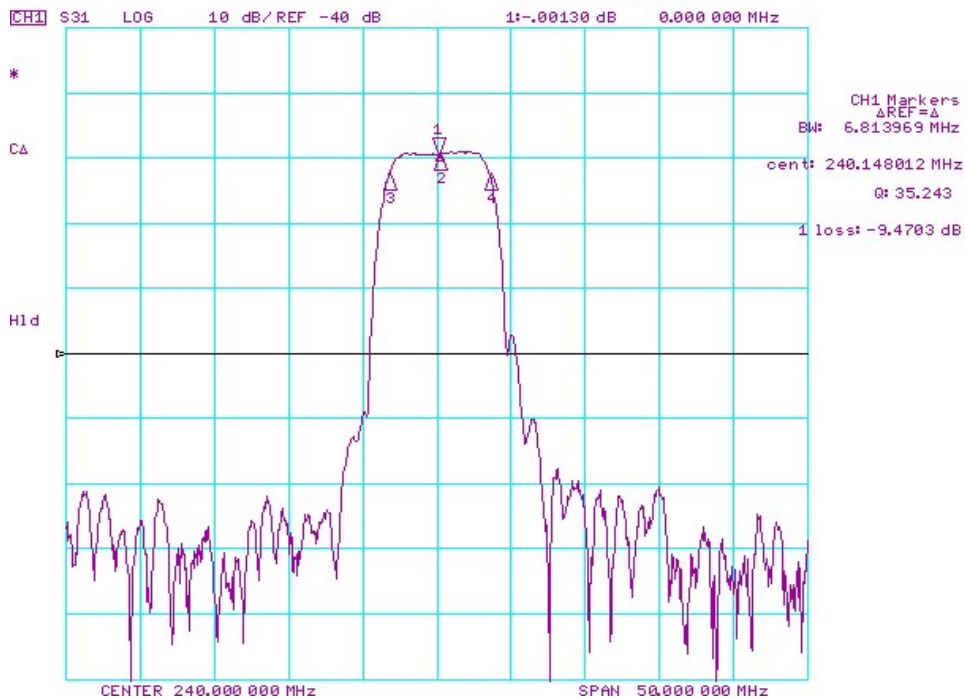

Fig-1 S21 Response Horizontal: 5MHz/Div Vertical: 10dB/Div

(2) Passband of Response:

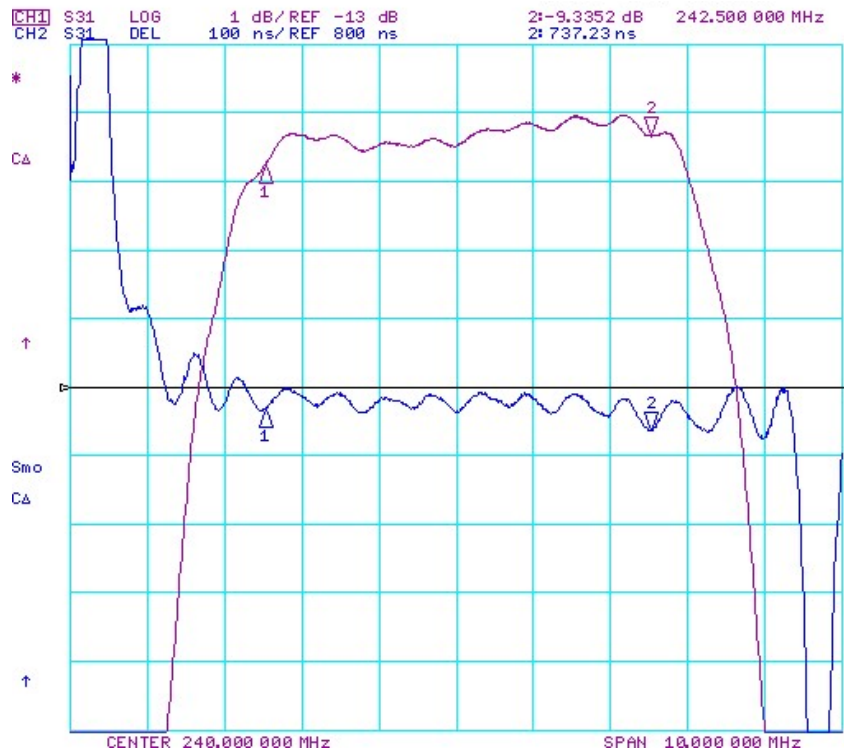
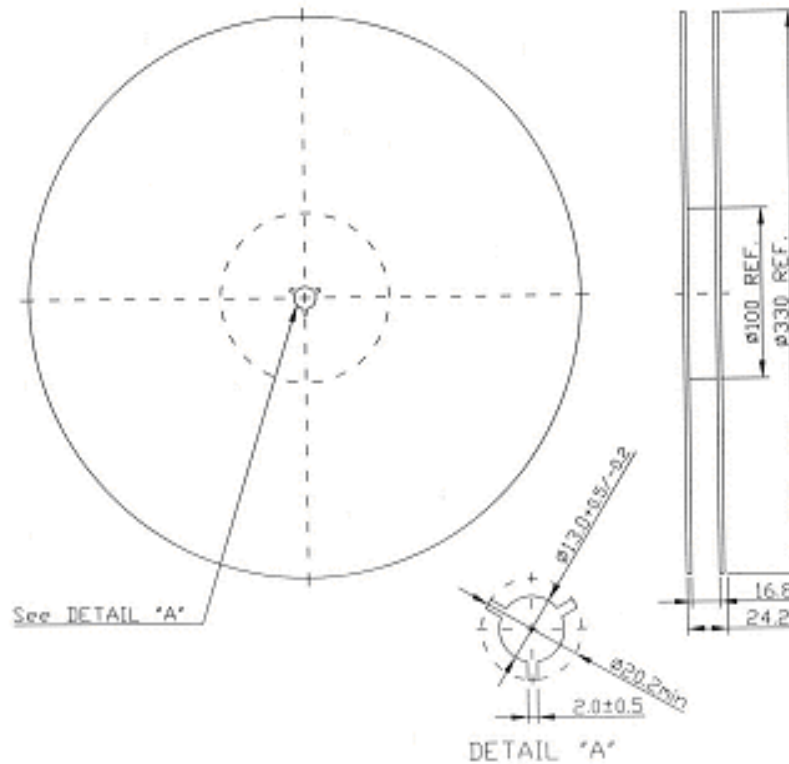

Fig-2 S21 Response Horizontal: 1MHz/Div Vertical: 1dB/Div
100ns/Div

G. PACKING:

1. REEL DIMENSION



2. TAPE DIMENSION

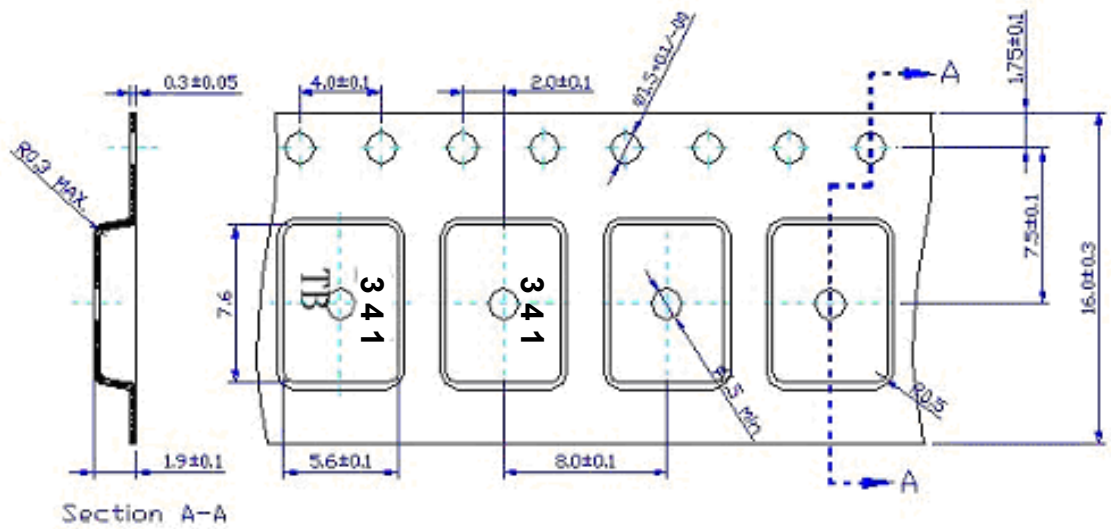

H. RECOMMENDED REFLOW PROFILE:

