

MTPS9067P

Point Source LED

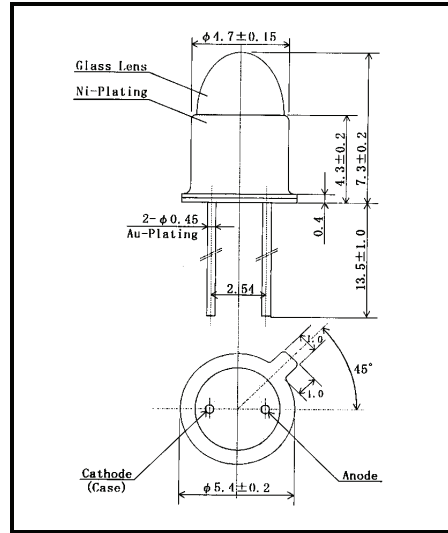

Dimensions (Unit:mm)

- FEATURES**
- Red Color Point-Source LED
 - Emitting Window Dia. ϕ 150 μ m
 - Parallel Rays (Super Excellent)
 - Narrow Beam (Super Excellent)
 - Small Temp. Coefficient of PO
- APPLICATIONS**
- Optical Switches
 - Linear & Rotary Encoder

2.ELECTRICAL & OPTICAL CHARACTERISTICS (Ta=25°C)

ITEM	SYMBOL	CONDITIONS	MIN	TYP	MAX	UNIT
Power Output	PO	IF=20mA	0.2	0.4		mW
Forward Voltage	VF	IF=20mA		2.2	2.5	V
Reverse Current	IR	VR=5V			10	μ A
Peak Wavelength	λ_p	IF=20mA	630	650	670	nm
Spectral Line Half Width	$\Delta \lambda$	IF=20mA		20		nm
Half Intensity Beam Angle	θ	IF=20mA		± 2.5		deg.
Temp. Coefficient of PO	P/T	IF=10mA		-0.24		%/°C
Temp. Coefficient of VF	V/T	IF=10mA		-3.8		mV/°C

1. ABSOLUTE MAXIMUM RATINGS (Ta=25°C)

ITEM	SYMBOL	RATINGS	UNIT
Forward Current (DC)	IF	50	mA
Forward Current (Pulse)*1	IFP	0.3	A
Reverse Voltage	VR	5	V
Power Dissipation	PD	125	mW
Operating Temp.	Topr	-20 TO 85	°C
Storage Temp.	Tstg	-30 TO 100	°C
Junction Temp.	Tj	100	°C
Lead Soldering Temp.*2	Tls	260	°C

*1:Tw=10uS,T=10mS

*2:Time 5 Sec max,Position:Up to 3mm from the body

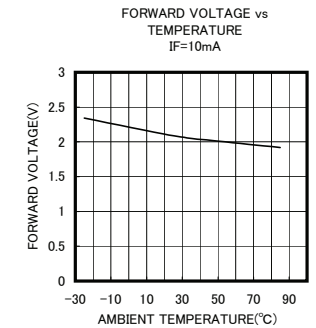
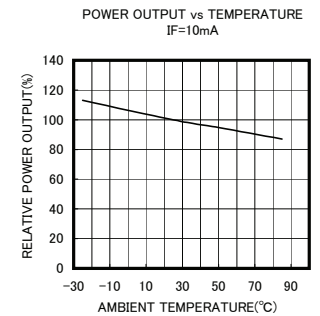
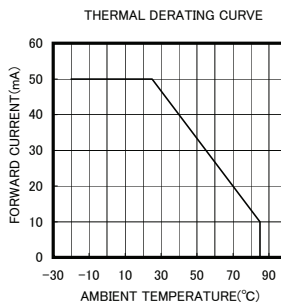
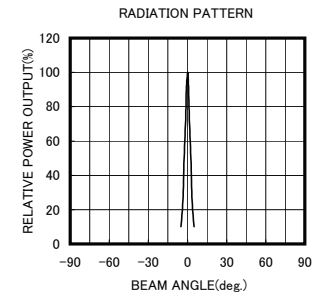
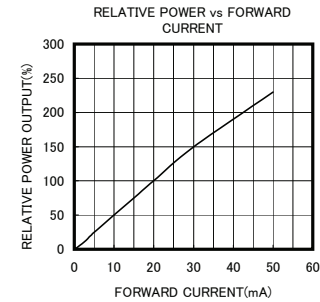
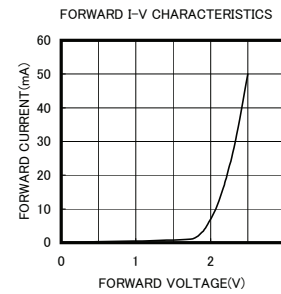
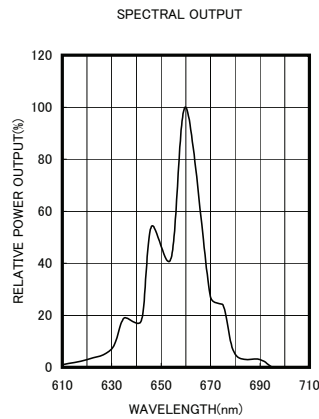

To purchase this part contact
Marktech Optoelectronics at

800.984.5337

Marktech
Optoelectronics
www.marktechopto.com

