

8-bit Proprietary Microcontroller

CMOS

F²MC-8L MB89180L Series

MB89183L/185L/P185/PV180

■ DESCRIPTION

The MB89180L series is a line of the general-purpose, single-chip microcontrollers. In addition to a compact instruction set, the microcontrollers contain a variety of peripheral functions such as an LCD controller/driver, timers, a serial interface, and external interrupts.

■ FEATURES

- F²MC-8L family CPU core
- Dual-clock control system
- Maximum memory size: 16-Kbyte ROM, 512-byte RAM (Max)
- Minimum execution time: 0.95 μ s/4.2 MHz
- I/O ports: Max 43 channels
- 21-bit time-base timer
- 8/16-bit timer/counter: 2 or 1 channels
- 8-bit serial I/O: 1 channel
- External interrupts (wake-up function): Four channels with edge detection plus eight level-interrupt channels
- Watch prescaler (15 bits)
- LCD controller/driver: 32 segments \times 4 commons (Max 128 pixels)
- LCD driving reference voltage generator
- Remote control transmission output
- Buzzer output
- Power-on reset function (option)
- Low-power consumption modes (stop, sleep, and watch mode)
- CMOS technology

MB89180L Series

■ PACKAGES

64-pin Plastic SQFP

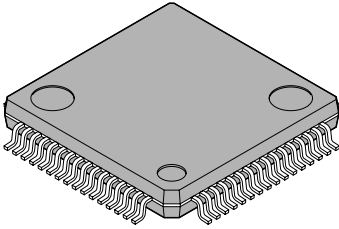

(FPT-64P-M03)

64-pin Plastic QFP

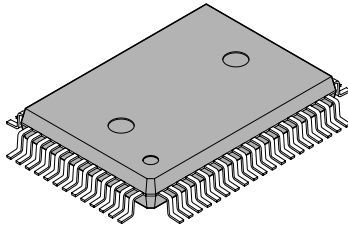

(FPT-64P-M06)

64-pin Plastic QFP

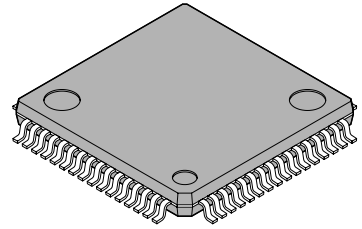

(FPT-64P-M09)

64-pin Ceramic MQFP

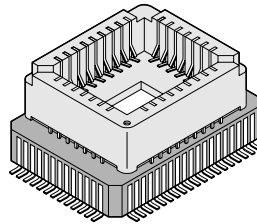

(MQP-64C-P01)

MB89180L Series

■ PRODUCT LINEUP

Part number Parameter	MB89183L	MB89185L	MB89P185	MB89PV180
Classification	Mass production products (mask ROM products)		One-time PROM product	Piggyback/evaluation product (for development)
ROM size	8 K × 8 bits (internal mask ROM)	16 K × 8 bits (internal mask ROM)	16 K × 8 bits (internal PROM, programming with general-purpose EPROM programmer)	32 K × 8 bits (external ROM)
RAM size	256 × 8 bits			512 × 8 bits
CPU functions	Number of instructions : 136 Instruction bit length : 8 bits Instruction length : 1 byte to 3 bytes Data bit length : 1, 8, 16 bits Minimum execution time : 0.95 μs/4.2 MHz Interrupt processing time : 8.6 μs to 137.1 μs /4.2 MHz			
Ports	I/O port (N-ch open-drain) : 8 (6 ports also serve as peripherals, 3 ports are a heavy-current drive type.) Output ports (N-ch open-drain) : 18 (16 ports also serve as segment pins ^{*2} , 2 ports also serve as common pins.) I/O ports (CMOS) : 16 (12 ports also serve as an external interrupt, 8 ports also serve as segment pins.) Output ports (CMOS) : 1 (Also serve as peripherals) Total : 43 (Max)			
Timer/counter	8-bit timer operation (toggled output capable, operating clock cycle 1.9 μs to 487.6 μs) 16-bit timer operation (toggled output capable, operating clock cycle 1.9 μs to 487.6 μs)			
Serial I/O	8 bits LSB first/MSB first selectability One clock selectable from four operation clocks (one external shift clock, three internal shift clocks: 1.9 μs, 7.6 μs, 30.5 μs)			
LCD controller/ driver	Common output : 4 (Max) Segment output : 32 (Max) ^{*2} Bias power supply pins : 3 LCD display RAM size : 32 × 4 bits Dividing resistor for LCD driving: Built-in (an external resistor selectability)			

(Continued)

MB89180L Series

(Continued)

Part number Parameter	MB89183L	MB89185L	MB89P185	MB89PV180
External interrupt 1 (wake-up function)	4 independent channels (edge selectability) Rising edge/falling edge selectability Used also for wake-up from stop/sleep mode. (Edge detection is also permitted in stop mode.)			
External interrupt 2 (wake-up function)	"L" level interrupts × 8 channels			
Buzzer output	1 (7 frequencies are selectable by the software.)			
Remote control transmission output	1 (Pulse width and cycle are software selectable.)			
Standby modes	Subclock mode, sleep mode, stop mode, and watch mode			
Process	CMOS			
Operating voltage	2.2 V to 3.6 V ^{*1}		2.7 V to 6.0 V	
EPROM for use				MBM27C256A-20TV

*1 : Varies with conditions such as the operating frequency.

*2 : See ■MASK OPTIONS.

■ PACKAGE AND CORRESPONDING PRODUCTS

Package	MB89183L	MB89185L	MB89P185	MB89PV180
FPT-64P-M03	○	○	×	×
FPT-64P-M06	○	○	○	×
FPT-64P-M09	○	○	○	×
MQP-64C-P01	×	×	×	○

○ : Available × : Not available

Note: For more information about each package, see ■PACKAGE DIMENSIONS.

■ DIFFERENCES AMONG PRODUCTS

1. Memory Size

Before evaluating using the piggyback product, verify its differences from the product that will actually be used. Take particular care on the following points:

- On the MB89183L, MB89185L and MB89P185, addresses 0180_H and later of the register bank cannot be used.
- The stack area, etc., is set at the upper limit of the RAM.

2. Current Consumption

- In the case of the MB89PV180, add the current consumed by the EPROM which is connected to the top socket.
- When operated at low speed, the product with an OTPROM (one-time PROM) or an EPROM will consume more current than the product with a mask ROM.

However, the current consumption in the sleep/stop modes is the same. (For more information, see ■ELECTRICAL CHARACTERISTICS.)

3. Mask Options

Functions that can be selected as options and how to designate these options vary by the product.

Before using options check ■MASK OPTIONS.

Take particular care on the following points:

- A pull-up resistor cannot be set for P20 to P27, P40 to P47 and P50 to P57 on the MB89P185.
- A pull-up resistor is not selectable for P10 to P17, P40 to P47 and P50 to P57 if they are used as LCD pins.
- Options are fixed on the MB89PV180.

MB89180L Series

■ PIN ASSIGNMENTS

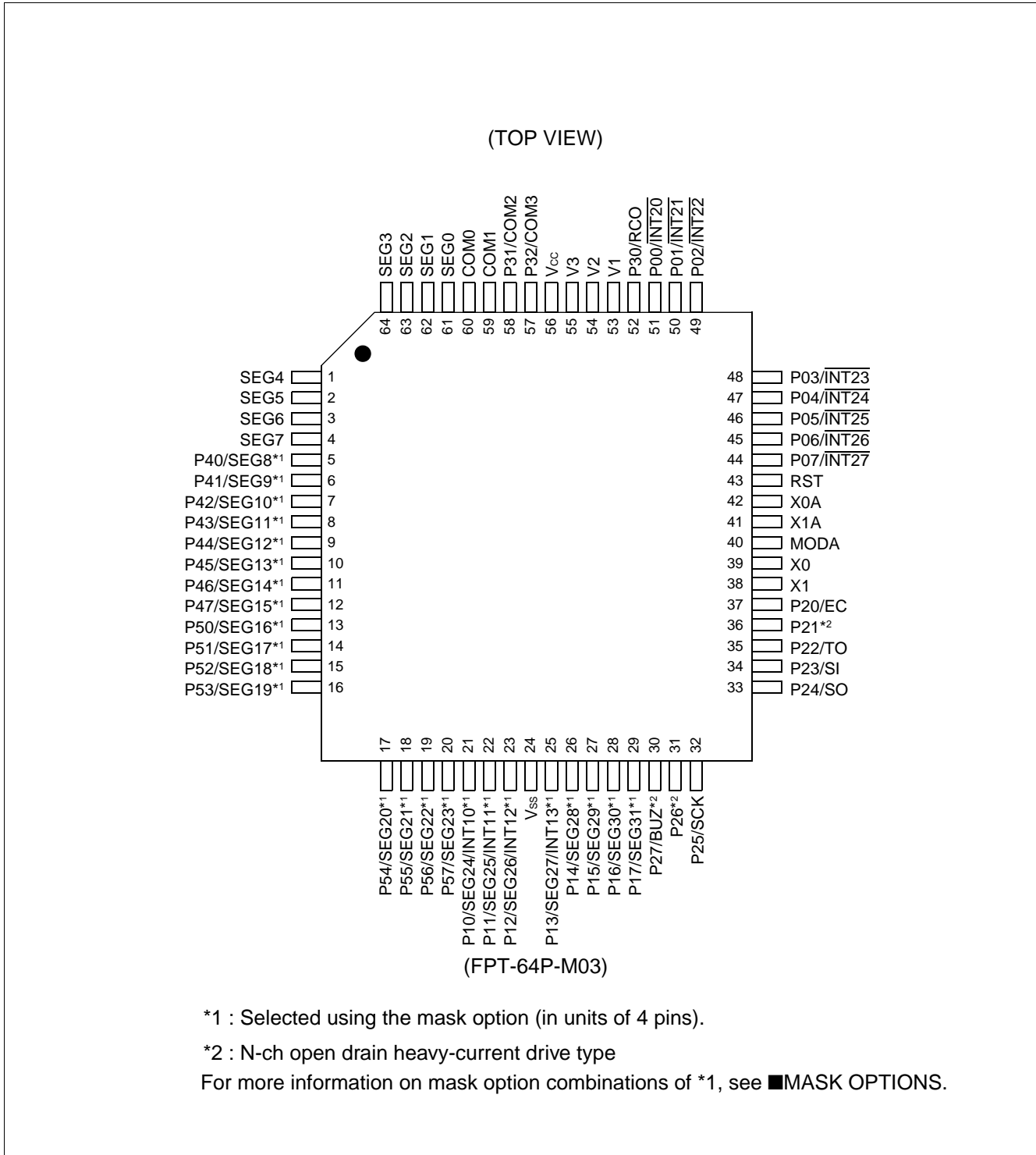

(Continued)

(TOP VIEW)

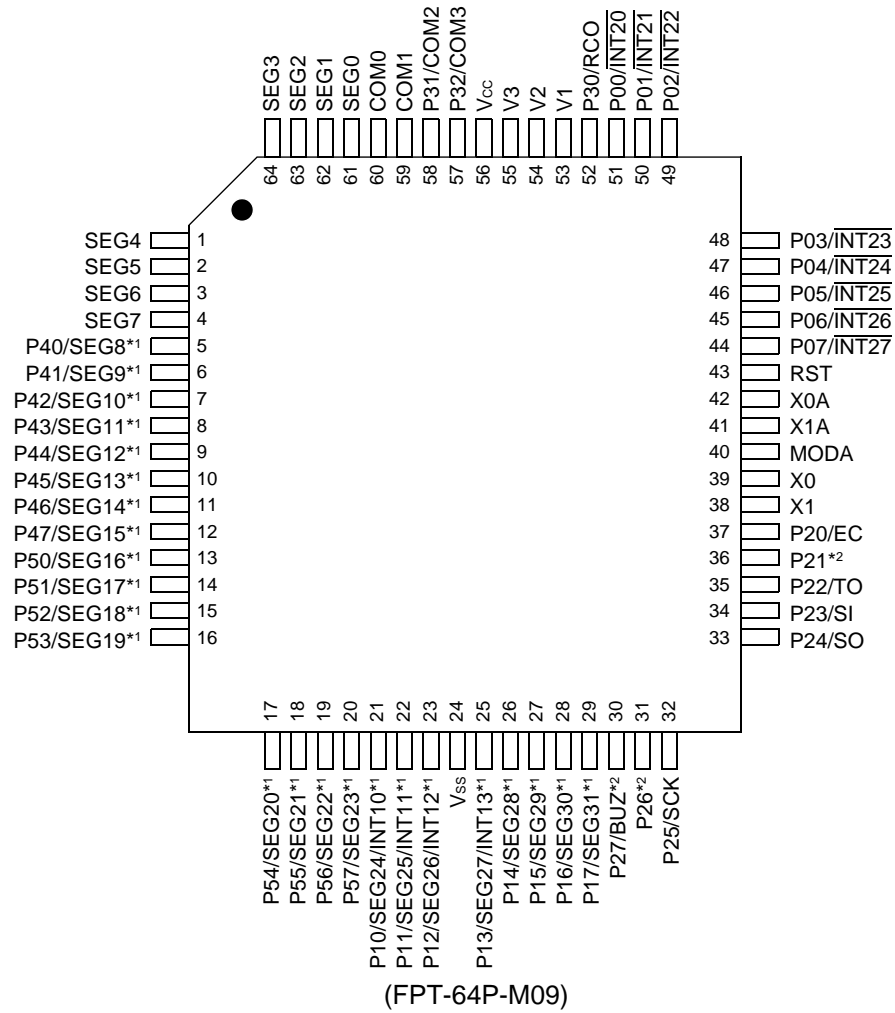

*1: Selected using the mask option (in units of 4 pins).

*2: N-ch open drain heavy-current drive type

For more information on mask option combinations of *1, see ■MASK OPTIONS.

(Continued)

MB89180L Series

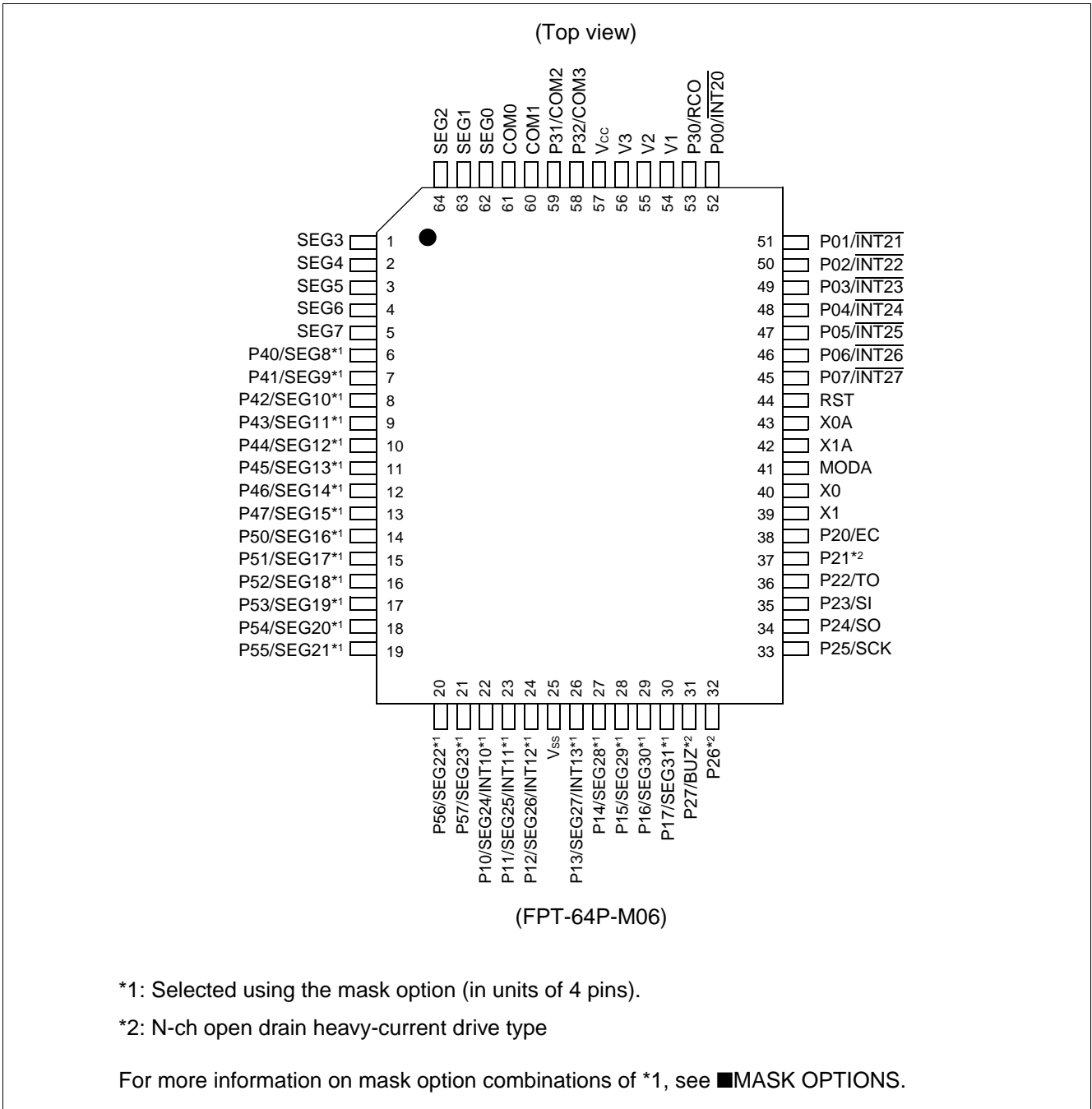

(Continued)

(Continued)

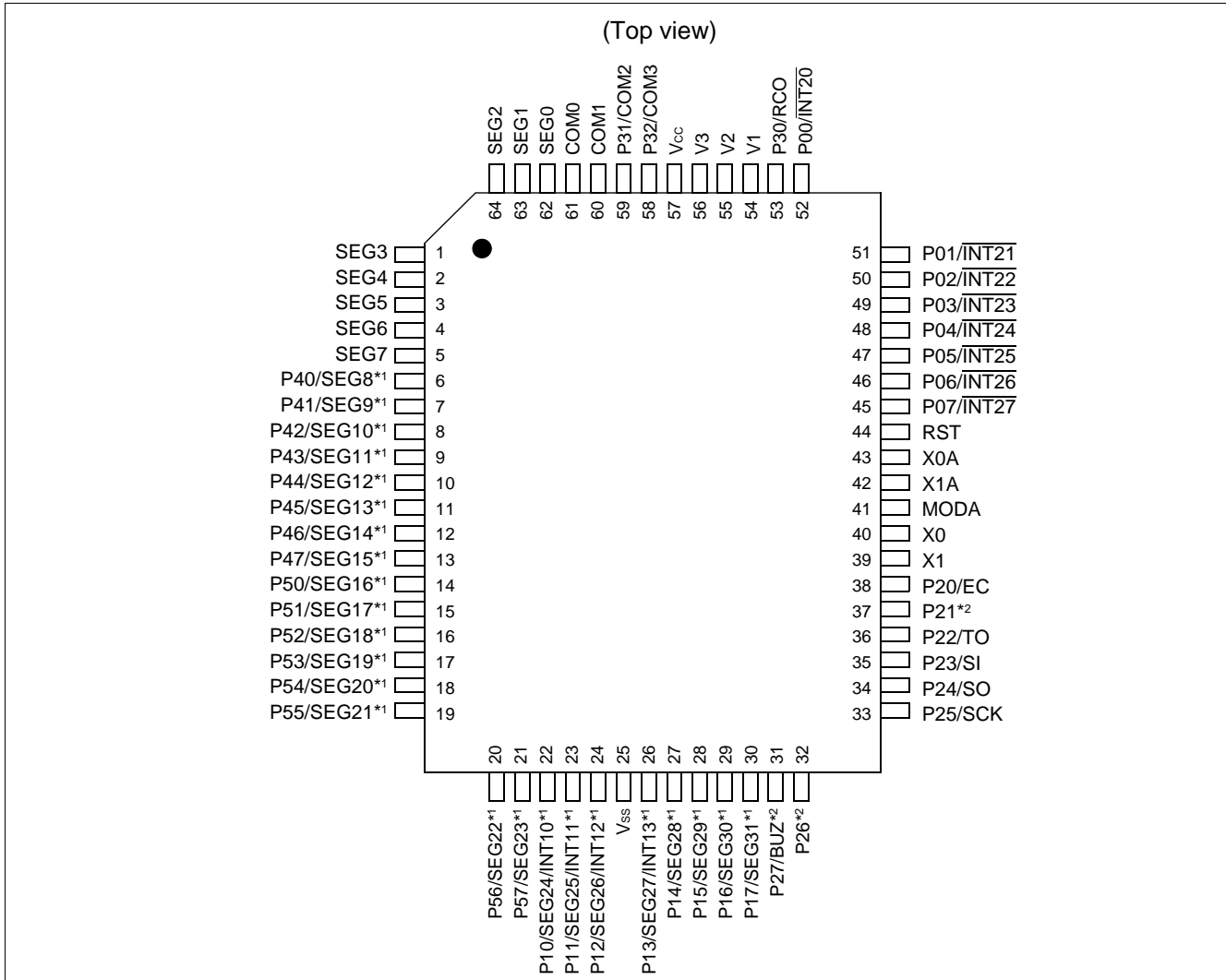

(MQP-64C-M01)

*1: Selected using the mask option (in units of 4 pins).

*2: N-ch open drain heavy-current drive type

Pin assignment on package top (MB89PV180 only)

Pin no.	Pin	Pin no.	Pin	Pin no.	Pin	Pin no.	Pin
65	N.C.	73	A2	81	N.C.	89	\overline{OE}
66	V _{PP}	74	A1	82	O4	90	N.C.
67	A12	75	A0	83	O5	91	A11
68	A7	76	N.C.	84	O6	92	A9
69	A6	77	O1	85	O7	93	A8
70	A5	78	O2	86	O8	94	A13
71	A4	79	O3	87	\overline{CE}	95	A14
72	A3	80	V _{SS}	88	A10	96	V _{CC}

N.C.: Internally connected. Do not use.

For more information on mask option combinations of *1, see ■MASK OPTIONS.

MB89180L Series

■ PIN DESCRIPTION

Pin no.		Pin name	I/O circuit type	Function
SQFP*1 QFP*2	MQFP*3 QFP*4			
39	40	X0	A	Crystal or other resonator connector pins for the main clock. The external clock can be connected to X0. When this is done, be sure to leave X1 open.
38	39	X1		
40	41	MODA	C	Memory access mode setting pin. Connect directly to Vss.
43	44	$\overline{\text{RST}}$	D	Reset I/O pin. This pin is an N-ch open-drain output type with a pull-up resistor, and a hysteresis input type. "L" is output from this pin by an internal reset request (optional). The internal circuit is initialized by the input of "L".
44 to 51	45 to 52	P07/ $\overline{\text{INT27}}$ to P00/ $\overline{\text{INT20}}$	E	General-purpose I/O ports. Also serve as an external interrupt 2 input (wake-up function). External interrupt 2 input is hysteresis input.
21 to 23	22 to 24	P10/SEG24/ INT10 to P12/SEG26/ INT12	E/K	General-purpose I/O ports. Also serve as input for external interrupt 1 input. The interrupt 1 input is a hysteresis type. Also serve as LCD controller/driver segment output. Switching is done by the mask option.
25	26	P13/SEG27/ INT13		
26 to 29	27 to 30	P14/SEG28 to P17/SEG31	F/K	General-purpose I/O ports. Also serve as LCD controller/driver segment output. Switching is done by the mask option.
37	38	P20/EC	H	General-purpose N-ch open-drain I/O port. Also serves as the external clock input for the 8-bit timer counter. The resource is a hysteresis input type.
36	37	P21	I	General-purpose N-ch open-drain I/O port.
35	36	P22/TO	I	General-purpose N-ch open-drain I/O port. Also serves as the 8-bit timer/counter output.
34	35	P23/SI	H	N-ch open-drain general-purpose I/O port. Also serves as the data input for the serial I/O. The peripheral is a hysteresis input type.
33	34	P24/SO	I	N-ch open-drain general-purpose I/O port. Also serves as the data output for the 8-bit serial I/O.
32	33	P25/SCK	H	N-ch open-drain general-purpose I/O port. Also serves as the clock I/O for the 8-bit serial I/O. The peripheral is a hysteresis input type.
31	32	P26	I	N-ch open-drain general-purpose I/O port.

(Continued)

MB89180L Series

(Continued)

Pin no.		Pin name	I/O circuit type	Function
SQFP*1 QFP*2	MQFP*3 QFP*4			
30	31	P27/BUZ	I	N-ch open-drain general-purpose I/O port. Also serves as buzzer output.
52	53	P30/RCO	G	General-purpose output-only port. Also serves as a remote control transmit output.
13 to 20	14 to 21	P50/SEG16 to P57/SEG23	J/K	N-ch open-drain general-purpose output ports. Also serve as an LCD controller/driver segment output. Switching between port and segment output is done by the mask option.
5 to 12	6 to 13	P40/SEG8 to P47/SEG15	J/K	
61 to 64 1 to 4	62 to 64 1 to 5	SEG7 to SEG0	K	LCD controller/driver segment output-only pins.
57, 58	58, 59	P32/COM3, P31/COM2	L	N-ch open-drain general-purpose output ports. Also serve as an LCD controller/driver common output pins.
59, 60	60, 61	COM1, COM0	K	LCD controller/driver common output-only pins.
53, 54, 55	54, 55, 56	V1, V2, V3	—	LCD driving power supply pins.
42	43	X0A	B	Subclock crystal oscillator pins (32.768 kHz)
41	42	X1A		
56	57	Vcc	—	Power supply pin.
24	25	Vss	—	Power supply (GND) pin.

*1 : FPT-64P-M03

*2 : FPT-64P-M09

*3 : MQP-64C-P01

*4 : FPT-64P-M06

MB89180L Series

- External EPROM pins (MB89PV180 only)

Pin no.	Pin name	I/O	Function
66	V _{PP}	O	"H" level output pin
67	A12	O	Address output pins
68	A7		
69	A6		
70	A5		
71	A4		
72	A3		
73	A2		
74	A1		
75	A0		
77	O1	I	Data input pins
78	O2		
79	O3		
80	V _{SS}	O	Power supply (GND) pin
82	O4	I	Data input pins
83	O5		
84	O6		
85	O7		
86	O8		
87	\overline{CE}	O	ROM chip enable pin Outputs "H" during standby.
88	A10	O	Address output pin
89	\overline{OE}	O	ROM output enable pin Outputs "L" at all times.
91	A11	O	Address output pins
92	A9		
93	A8		
94	A13		
95	A14	O	
96	V _{CC}	O	EPROM power supply pin
65	N.C.	—	Internally connected pins Be sure to leave them open.
76			
81			
90			

■ I/O CIRCUIT TYPE

Type	Circuit	Remarks
A		<p>Main clock (main clock crystal oscillator)</p> <ul style="list-style-type: none"> • At an oscillation feedback resistor of approximately 1 MΩ • CR oscillation is selectable. (MB8918X only)
B		<p>Subclock (subclock crystal oscillator)</p> <ul style="list-style-type: none"> • At an oscillation feedback resistor of approximately 4.5 MΩ
C		<ul style="list-style-type: none"> • Hysteresis input • The pull-down resistor (R) is approximately 50 kΩ for MB89183L/185L only.
D		<ul style="list-style-type: none"> • At an output pull-up resistor (P-ch) of approximately 50 kΩ • Hysteresis input
E		<ul style="list-style-type: none"> • CMOS output • CMOS input • The peripheral is a hysteresis input type. • Pull-up resistor optional (except MB89PV180) • Approximately 50 kΩ
F		<ul style="list-style-type: none"> • CMOS output • CMOS input • Pull-up resistor optional (except MB89PV180) • Approximately 50 kΩ

(Continued)

MB89180L Series

(Continued)

Type	Circuit	Remarks
G		<ul style="list-style-type: none"> • CMOS output • P-ch output is a heavy-current drive type.
H		<ul style="list-style-type: none"> • N-ch open-drain output • CMOS input • The peripheral is a hysteresis input type. • Pull-up resistor optional (except MB89P185, and MB89PV180) Approximately 50 kΩ
I		<ul style="list-style-type: none"> • N-ch open-drain output • CMOS input • P21, P26, and P27 are a heavy-current drive type. • Pull-up resistor optional (except MB89P185 and MB89PV180) Approximately 50 kΩ
J		<ul style="list-style-type: none"> • N-ch open-drain output • Pull-up resistor optional (except MB89P185 and MB89PV180) Approximately 50 kΩ
K		<ul style="list-style-type: none"> • LCD controller/driver common/segment output
L		<ul style="list-style-type: none"> • N-ch open-drain output • Common output

■ HANDLING DEVICES

1. Preventing Latchup

Latchup may occur on CMOS ICs if voltage higher than V_{CC} or lower than V_{SS} is applied to input and output pins other than medium- to high-voltage pins or if higher than the voltage which shows on “1. Absolute Maximum Ratings” in ■ELECTRICAL CHARACTERISTICS is applied between V_{CC} to V_{SS} .

When latchup occurs, power supply current increases rapidly and might thermally damage elements. When using, take great care not to exceed the absolute maximum ratings.

2. Treatment of Unused Input Pins

Leaving unused input pins open could cause malfunctions. They should be connected to a pull-up or pull-down resistor.

3. Treatment of N.C. Pin

Be sure to leave (internally connected) N.C. pins open.

4. Power Supply Voltage Fluctuations

Although V_{CC} power supply voltage is assured to operate within the rated range, a rapid fluctuation of the voltage could cause malfunctions, even if it occurs within the rated range. Stabilizing voltage supplied to the IC is therefore important. As stabilization guidelines, it is recommended to control power so that V_{CC} ripple fluctuations (P-P value) will be less than 10% of the standard V_{CC} value at the commercial frequency (50 Hz to 60 Hz) and the transient fluctuation rate will be less than 0.1 V/ms at the time of a momentary fluctuation such as when power is switched.

5. Precautions when Using an External Clock

Even when an external clock is used, oscillation stabilization time is required for power-on reset (optional) and wake-up from stop mode.

6. Note to Noise in the External Reset Pin (\overline{RST})

If the reset pulse applied to the external reset pin (\overline{RST}) does not meet the specifications, it may cause malfunctions. Use caution so that the reset pulse less than the specifications will not be fed to the external reset pin (\overline{RST}).

MB89180L Series

PROGRAMMING TO THE EPROM ON THE MB89P185

The MB89P185 is an OTPROM version of the MB89180L series.

1. Features

- 16-Kbyte PROM on chip
- Options can be set using the EPROM programmer.
- Equivalency to the MBM27C256A in EPROM mode (when programmed with the EPROM programmer)

2. Memory Space

Memory space in each mode such as 16-Kbyte PROM, option area is diagrammed below.

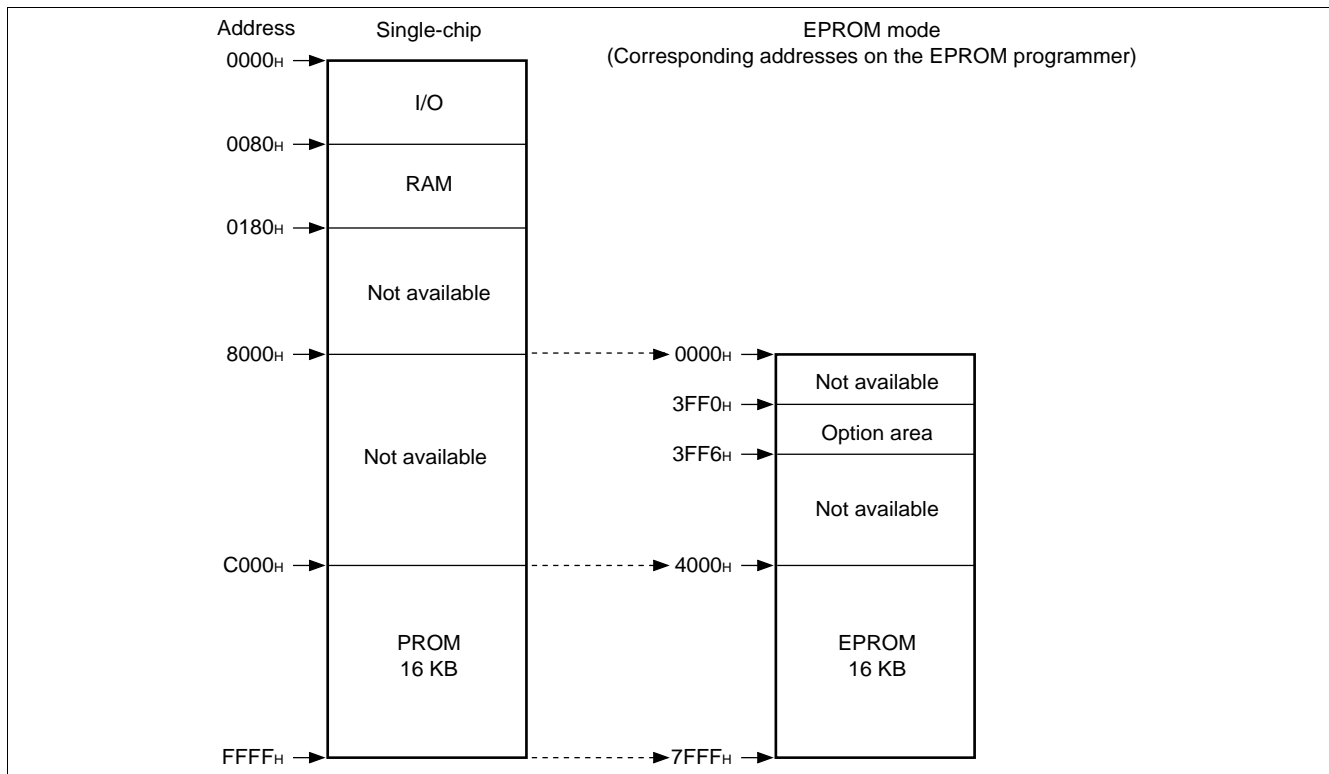

3. Programming to the EPROM

In EPROM mode, the MB89P185 functions equivalent to the MBM27C256A. This allows the PROM to be programmed with a general-purpose EPROM programmer (the electronic signature mode cannot be used) by using the dedicated socket adapter.

When the operating area for a single chip is 16 Kbyte (C000H to FFFFH) the PROM can be programmed as follows:

• Programming procedure

- (1) Set the EPROM programmer to the MBM27C256A.
- (2) Load program into the EPROM programmer at 4000H to 7FFFH.
(Note that addresses C000H to FFFFH while operating as a single chip assign to 4000H to 7FFFH in EPROM mode.)
Load option data into address 3FF0H to 3FF5H of the EPROM programmer.
(For information about each corresponding option, see "7. Setting OTPROM Options.")
- (3) Program with the EPROM programmer.

4. Recommended Screening Conditions

High-temperature aging is recommended as the pre-assembly screening procedure for a product with a blanked OTPROM microcomputer program.

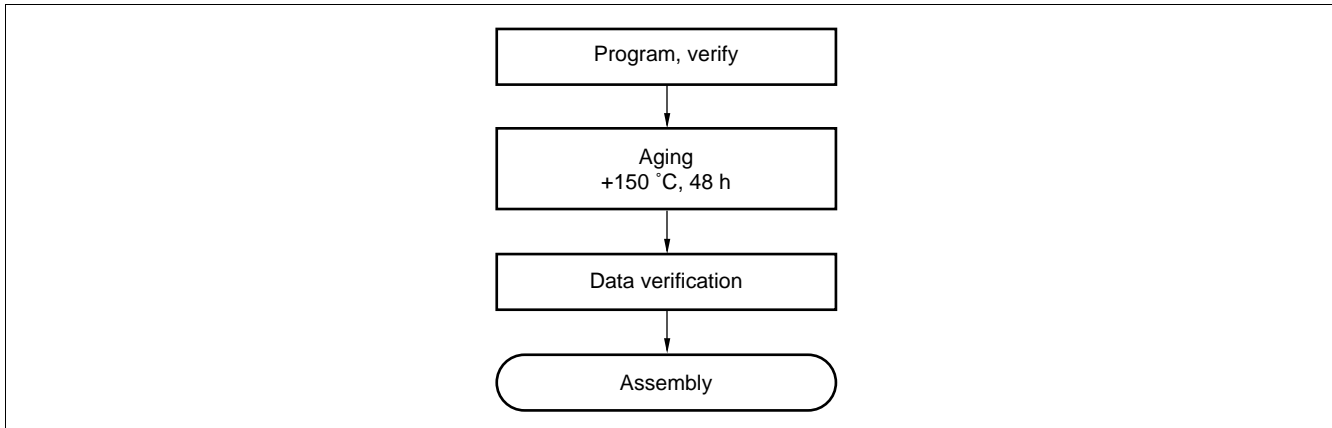

5. Programming Yield

All bits cannot be programmed at Fujitsu shipping test to a blanked OTPROM microcomputer, due to its nature. For this reason, a programming yield of 100% cannot be assured at all times.

6. EPROM Programmer Adapter Socket

Package	Compatible adapter socket
FPT-64P-M09	ROM-64QF2-28DP-8L2
FPT-64P-M06	ROM-64QF-28DP-8L3

MB89180L Series

7. Setting OTPROM Options

The programming procedure is the same as that for the PROM. Options can be set by programming value at the addresses shown on the memory map. The relationship between bits and options is shown on the following bit map:

• OTPROM option bit map

	Bit 7	Bit 6	Bit 5	Bit 4	Bit 3	Bit 2	Bit 1	Bit 0
3FF0 _H	Vacancy	Vacancy	Oscillation stabilization time		Vacancy	Reset pin output 1: Yes 0: No	Clock mode selection 1: Dual clock 0: Single clock	Power-on reset 1: Yes 0: No
	Readable	Readable	WTM1 See ■MASK OPTIONS.	WTM0	Readable			
3FF1 _H	P07 Pull-up 1: No 0: Yes	P06 Pull-up 1: No 0: Yes	P05 Pull-up 1: No 0: Yes	P04 Pull-up 1: No 0: Yes	P03 Pull-up 1: No 0: Yes	P02 Pull-up 1: No 0: Yes	P01 Pull-up 1: No 0: Yes	P00 Pull-up 1: No 0: Yes
	P17 Pull-up 1: No 0: Yes	P16 Pull-up 1: No 0: Yes	P15 Pull-up 1: No 0: Yes	P14 Pull-up 1: No 0: Yes	P13 Pull-up 1: No 0: Yes	P12 Pull-up 1: No 0: Yes	P11 Pull-up 1: No 0: Yes	P10 Pull-up 1: No 0: Yes
3FF3 _H	Vacancy	Vacancy	Vacancy	Vacancy	Vacancy	Vacancy	Vacancy	Vacancy
	Readable	Readable	Readable	Readable	Readable	Readable	Readable	Readable
3FF4 _H	Vacancy	Vacancy	Vacancy	Vacancy	Vacancy	Vacancy	Vacancy	Vacancy
	Readable	Readable	Readable	Readable	Readable	Readable	Readable	Readable
3FF5 _H	Vacancy	Vacancy	Vacancy	Vacancy	Vacancy	Vacancy	Vacancy	Vacancy
	Readable	Readable	Readable	Readable	Readable	Readable	Readable	Readable

- Notes :
- Set each bit to 1 to erase.
 - Do not write 0 to the vacant bit.
The read value of the vacant bit is 1, unless 0 is written to it.
 - Address 3FF6_H cannot be read and should not be accessed.

■ PROGRAMMING TO THE EPROM WITH PIGGYBACK/EVALUATION DEVICE

1. EPROM for Use

MBM27C256A-20TV

2. Programming Socket Adapter

To program to the PROM using an EPROM programmer, use the socket adapter (manufacturer: Sun Hayato Co., Ltd.) listed below.

Package	Adapter socket part number
LCC-32 (Rectangle)	ROM-32LC-28DP-YG
LCC-32 (Square)	ROM-32LC-28DP-S

Inquiry: Sunhayato Corp. : TEL : 81-3-3984-7791
 FAX : 81-3-3971-0535
 E-mail : adapter@sunhayato.co.jp

3. Memory Space

Memory space in each mode, such as 16-Kbyte PROM, option area is diagrammed below.

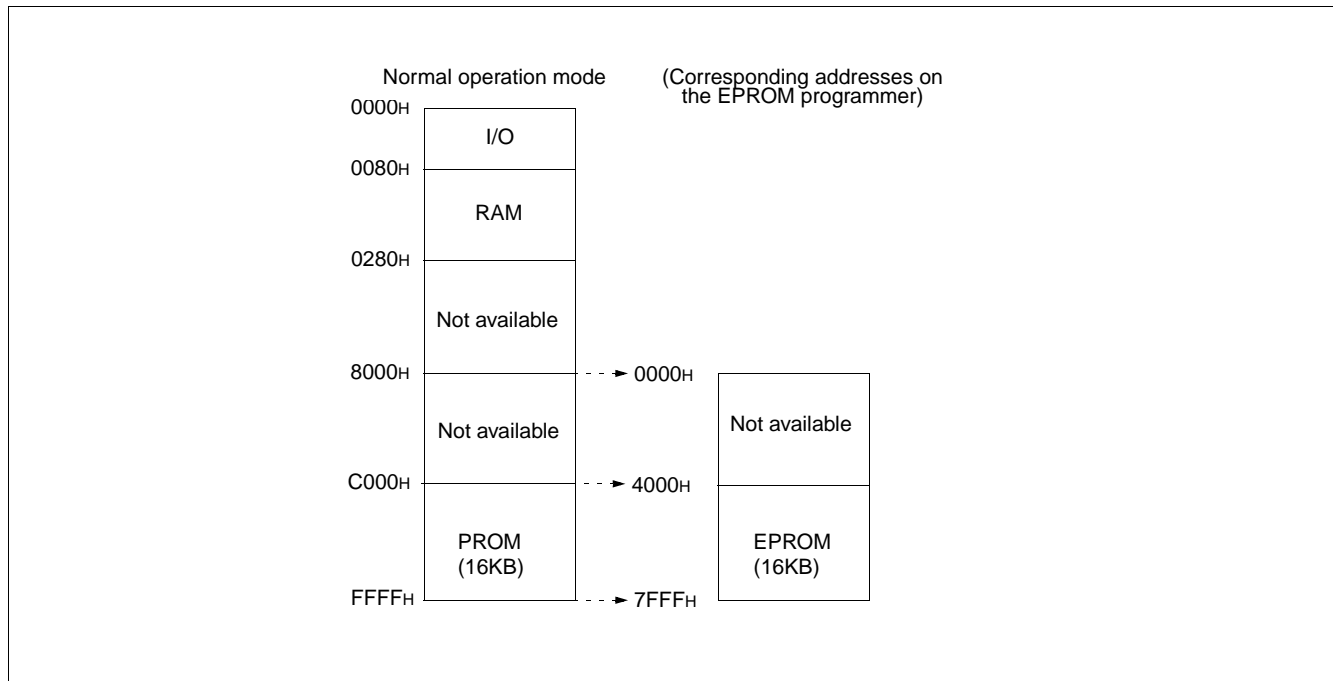

4. Programming to the EPROM

- (1) Set the EPROM programmer to the MBM27C256A.
- (2) Load program data into the EPROM programmer at 4000_H to 7FFF_H.
- (3) Program to 4000_H to 7FFF_H with the EPROM programmer.

MB89180L Series

■ BLOCK DIAGRAM

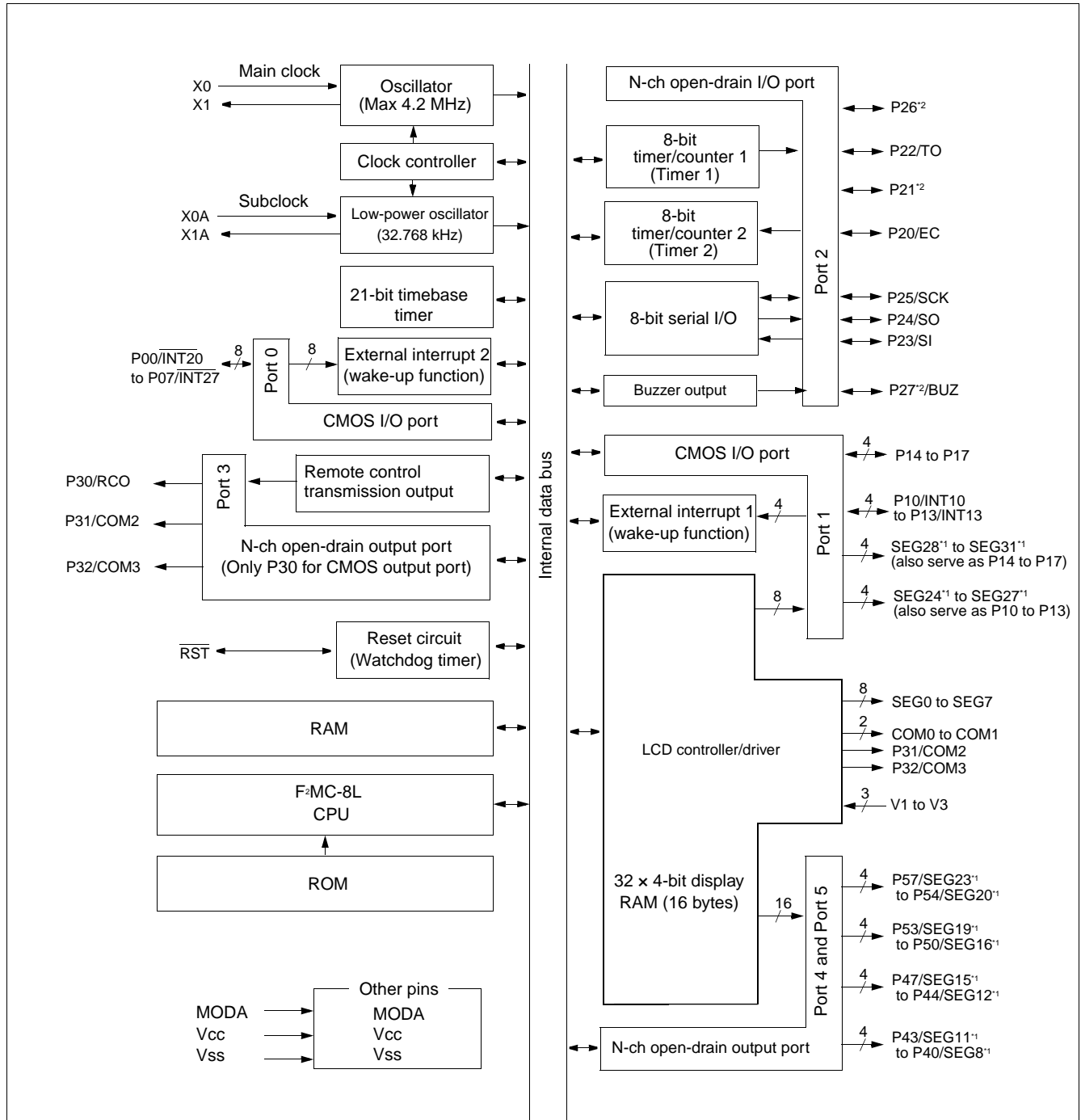

*1: The segment or port function is selected by the mask option.

*2: N-ch open-drain heavy-current drive type.

■ CPU CORE

1. Memory Space

The microcontrollers of the MB89180L series offer a memory space of 64 Kbytes for storing all of I/O, data, and program areas. The I/O area is located at the lowest address. The data area is provided immediately above the I/O area. The data area can be divided into register, stack, and direct areas according to the application. The program area is located at exactly the opposite end, that is, near the highest address. Provide the tables of interrupt reset vectors and vector call instructions toward the highest address within the program area. The memory space of the MB89180L series is structured as illustrated below.

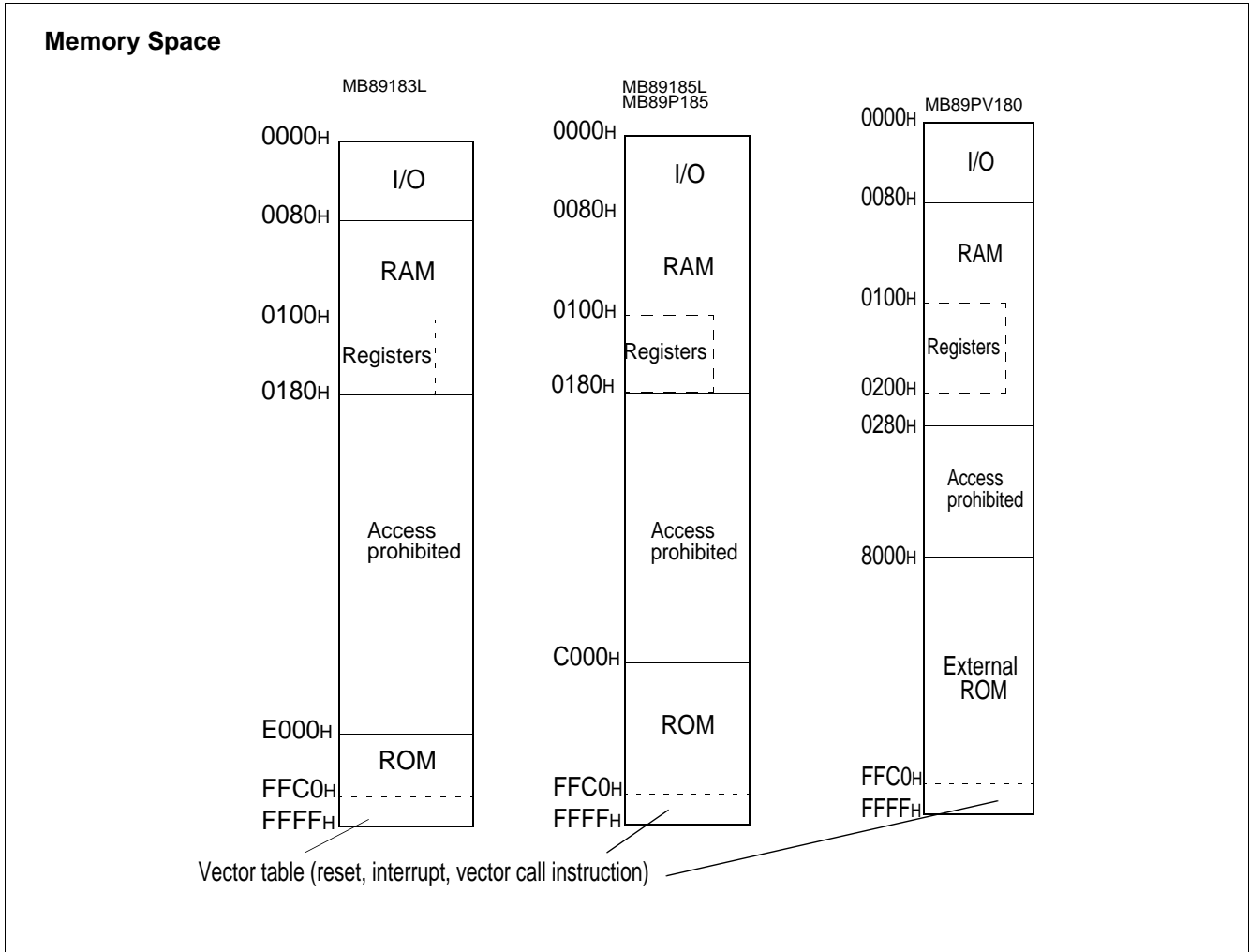

MB89180L Series

2. Registers

The F²MC-8L family has two types of registers; dedicated registers in the CPU and general-purpose registers in the memory. The following dedicated registers are provided:

- Program counter (PC) : A 16-bit register for indicating instruction storage positions
- Accumulator (A) : A 16-bit temporary register for storing arithmetic operations, etc. When the instruction is an 8-bit data processing instruction, the lower byte is used.
- Temporary accumulator (T) : A 16-bit register which performs arithmetic operations with the accumulator. When the instruction is an 18-bit data processing instruction, the lower byte is used.
- Index register (IX) : A 16-bit register for index modification
- Extra pointer (EP) : A 16-bit pointer for indicating a memory address
- Stack pointer (SP) : A 16-bit register for indicating a stack area
- Program status (PS) : A 16-bit register for storing a register pointer, a condition code

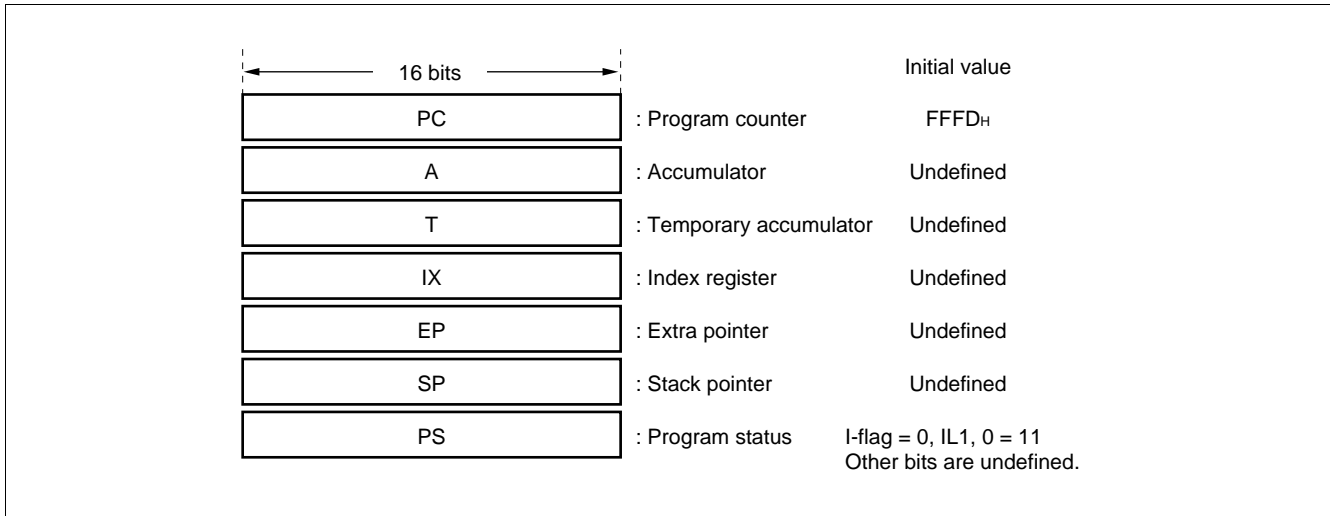

The PS can further be divided into higher 8 bits for use as a register bank pointer (RP) and the lower 8 bits for use as a condition code register (CCR). (See the diagram below.)

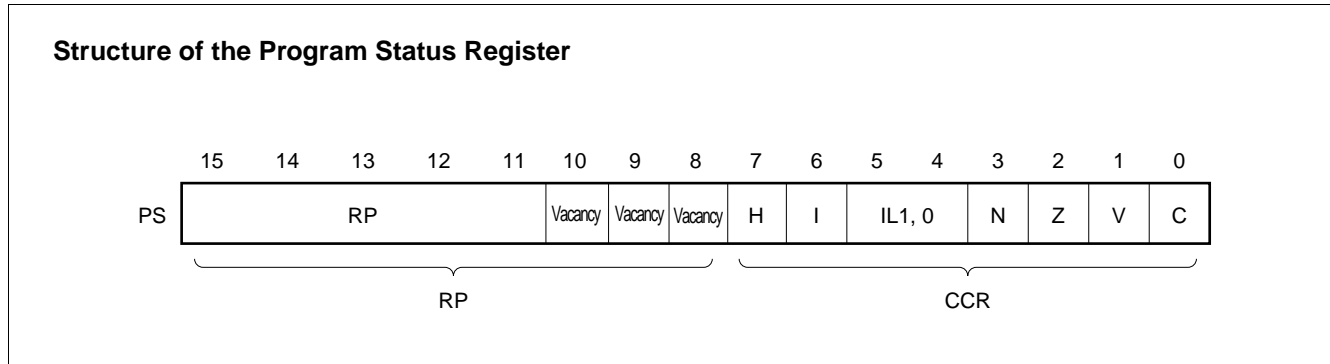

MB89180L Series

The following general-purpose registers are provided:

General-purpose registers: An 8-bit register for storing data

The general-purpose registers are 8 bits and located in the register banks of the memory. One bank contains eight registers. Up to a total of 16 banks can be used on the MB89183L, MB89185L and MB89P185 (RAM 256×8 bits), and a total of 32 banks can be used on the MB89PV180 (RAM 512×8 bits). The bank currently in use is indicated by the register bank pointer (RP).

Note : The number of register banks that can be used varies with the RAM size.

Register Bank Configuration

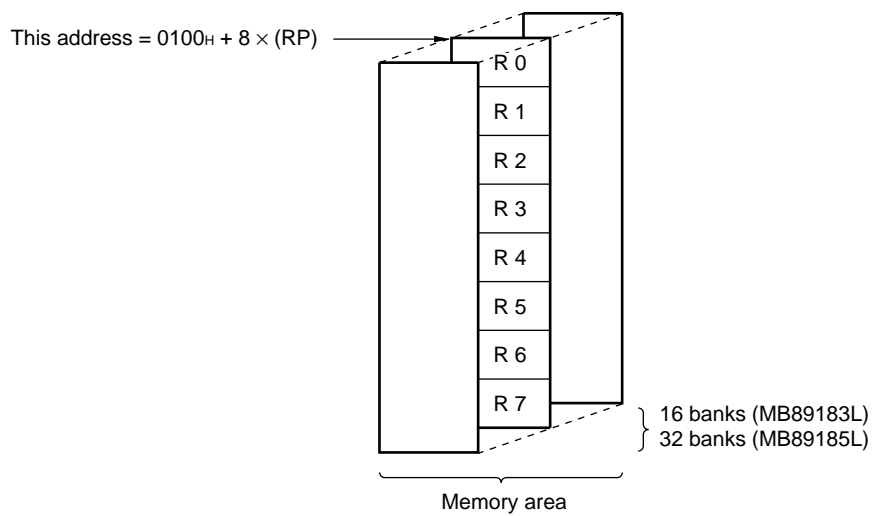

■ I/O MAP

Address	Read/write	Register name	Register description
00 _H	(R/W)	PDR0	Port 0 data register
01 _H	(W)	DDR0	Port 0 data direction register
02 _H	(R/W)	PDR1	Port 1 data register
03 _H	(W)	DDR1	Port 1 data direction register
04 _H	(R/W)	PDR2	Port 2 data register
05 _H	(W)	DDR2	Port 2 data direction register
06 _H			Vacancy
07 _H	(R/W)	SYCC	System clock control register
08 _H	(R/W)	STBC	Standby control register
09 _H	(R/W)	WDTC	Watchdog timer control register
0A _H	(R/W)	TBTC	Time-base timer control register
0B _H	(R/W)	WPCR	Watch prescaler control register
0C _H	(R/W)	PDR3	Port 3 data register
0D _H			Vacancy
0E _H	(R/W)	PDR4	Port 4 data register
0F _H	(R/W)	PDR5	Port 5 data register
10 _H	(R/W)	BUZR	Buzzer register
11 _H to 13 _H			Vacancy
14 _H	(R/W)	RCR1	Remote control transmission register 1
15 _H	(R/W)	RCR2	Remote control transmission register 2
16 _H to 17 _H			Vacancy
18 _H	(R/W)	T2CR	Timer 2 control register
19 _H	(R/W)	T1CR	Timer 1 control register
1A _H	(R/W)	T2DR	Timer 2 data register
1B _H	(R/W)	T1DR	Timer 1 data register
1C _H	(R/W)	SMR	Serial mode register
1D _H	(R/W)	SDR	Serial data register
1E _H to 2F _H			Vacancy

(Continued)

MB89180L Series

(Continued)

Address	Read/write	Register name	Register description
30 _H	(R/W)	EIE1	External interrupt 1 enable register 1
31 _H	(R/W)	EIF1	External interrupt 1 flag register 1
32 _H	(R/W)	EIE2	External interrupt 2 enable register 2
33 _H	(R/W)	EIF2	External interrupt 2 flag register 2
34 _H to 5F _H			Vacancy
60 _H to 6F _H	(R/W)	VRAM	Display data RAM
70 _H to 71 _H			Vacancy
72 _H	(R/W)	LCR1	LCD controller/driver control register 1
73 _H to 7B _H			Vacancy
7C _H	(W)	ILR1	Interrupt level setting register 1
7D _H	(W)	ILR2	Interrupt level setting register 2
7E _H	(W)	ILR3	Interrupt level setting register 3
7F _H	Access prohibited	ITR	Interrupt test register

Note : Do not use vacancies.

■ ELECTRICAL CHARACTERISTICS

1. Absolute Maximum Ratings

($V_{SS} = 0.0\text{ V}$)

Parameter	Symbol	Rating		Unit	Remarks
		Min	Max		
Power supply voltage	V_{CC}	$V_{SS} - 0.3$	$V_{SS} + 4.0$	V	For MB89183L/185L
		$V_{SS} - 0.3$	$V_{SS} + 7.0$	V	For MB89PV180/P185
LCD power supply voltage	V1 to V3	$V_{SS} - 0.3$	$V_{SS} + 4.0$	V	For MB89183L/185L V1 to V3 must not exceed V_{CC} .
		$V_{SS} - 0.3$	$V_{SS} + 7.0$	V	For MB89PV180/P185 V1 to V3 must not exceed V_{CC} .
Input voltage	V_{I1}	$V_{SS} - 0.3$	$V_{CC} + 0.3$	V	V_{I1} must not exceed $V_{SS} + 4.0\text{ V}$ for MB89183L/185L and $V_{SS} + 7.0\text{ V}$ for MB89PV180/P185. All pins except P20 to P27 without a pull-up resistor
	V_{I2}	$V_{SS} - 0.3$	$V_{SS} + 4.0$	V	P20 to P27 without a pull-up resistor for MB89183L/185L
		$V_{SS} - 0.3$	$V_{SS} + 7.0$	V	P20 to P27 without a pull-up resistor for MB89PV180/P185
Output voltage	V_{O1}	$V_{SS} - 0.3$	$V_{CC} + 0.3$	V	V_{O1} must not exceed $V_{SS} + 4.0\text{ V}$ for MB89183L/185L and $V_{SS} + 7.0\text{ V}$ for MB89PV180/P185. All pins except P20 to P27, P40 to P47, and P50 to P57 without a pull-up resistor
	V_{O2}	$V_{SS} - 0.3$	$V_{SS} + 4.0$	V	P20 to P27, P40 to P47, and P50 to P57 without a pull-up resistor for MB89183L/185L
		$V_{SS} - 0.3$	$V_{SS} + 7.0$	V	P20 to P27, P40 to P47, and P50 to P57 without a pull-up resistor for MB89PV180/P185
“L” level maximum output current	I_{OL1}	—	10	mA	All pins except P21, P26, and P27
	I_{OL2}	—	20	mA	P21, P26, and P27
“L” level average output current	I_{OLAV1}	—	4	mA	All pins except P21, P26, P27, and power supply pins Average value (operating current × operating rate)
	I_{OLAV2}	—	8	mA	P21, P26, and P27 Average value (operating current × operating rate)
“L” level total maximum output current	ΣI_{OL}	—	80	mA	Peak value
“L” level total average output current	ΣI_{OLAV}	—	40	mA	Average value (operating current × operating rate)

(Continued)

MB89180L Series

(Continued)

Parameter	Symbol	Value		Unit	Remarks
		Min	Max		
“H” level maximum output current	I _{OH1}	—	–5	mA	All pins except P30 and power supply pins
	I _{OH2}	—	–10	mA	P30
“H” level average output current	I _{OHAV1}	—	–2	mA	All pins except P30 and power supply pins Average value (operating current × operating rate)
	I _{OHAV2}	—	–4	mA	P30 Average value (operating current × operating rate)
“H” level total maximum output current	ΣI _{OH}	—	–20	mA	Peak value
“H” level total average output current	ΣI _{OHAV}	—	–10	mA	Average value (operating current × operating rate)
Power consumption	P _D	—	300	mW	
Operating temperature	T _A	–40	+85	°C	
Storage temperature	T _{stg}	–55	+150	°C	

WARNING: Semiconductor devices can be permanently damaged by application of stress (voltage, current, temperature, etc.) in excess of absolute maximum ratings. Do not exceed these ratings.

2. Recommended Operating Conditions

(V_{SS} = 0.0 V)

Parameter	Symbol	Value		Unit	Remarks
		Min	Max		
Power supply voltage	V _{CC}	2.2	3.6	V	Normal operation assurance range for MB89183L/185L
		2.7	6.0	V	Normal operation assurance range for MB89PV180 and MB89P185
		1.5	3.6	V	Retains the RAM state in stop mode for MB89183L/185L
		1.5	6.0	V	Retains the RAM state in stop mode for MB89PV180 and MB89P185
LCD power supply voltage	V1 to V3	V _{SS}	V _{CC} *	V	V1 to V3 pins LCD power supply range (The optimum value dependent on the LCD element in use.)
Operating temperature	T _A	–40	+85	°C	

* : The liquid-crystal power supply range and optimum value vary depending on the characteristics of the liquid-crystal display element used.

MB89180L Series

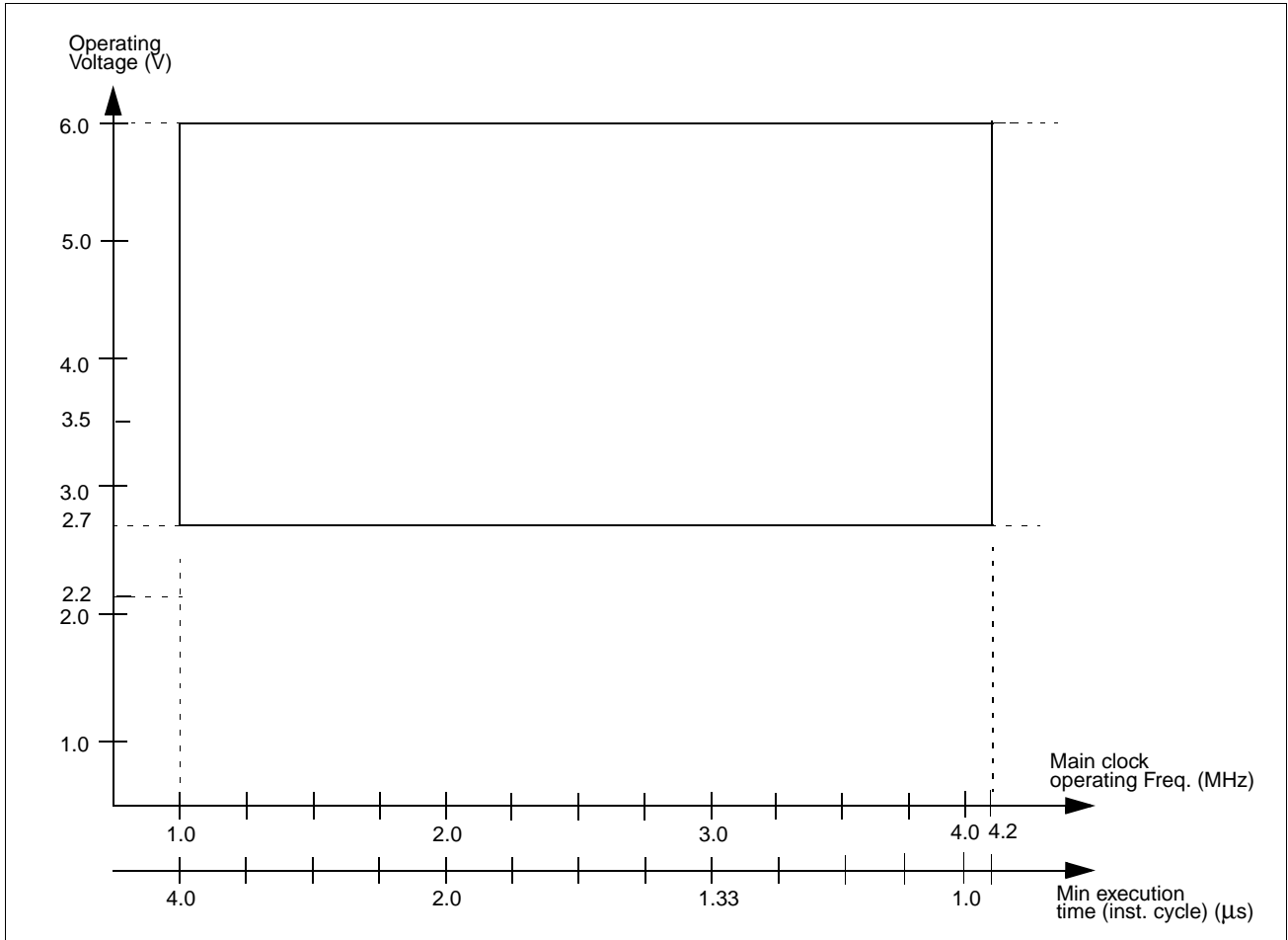

Operating Voltage vs. Main Clock Operating Frequency (MB89PV180/P185)

MB89180L Series

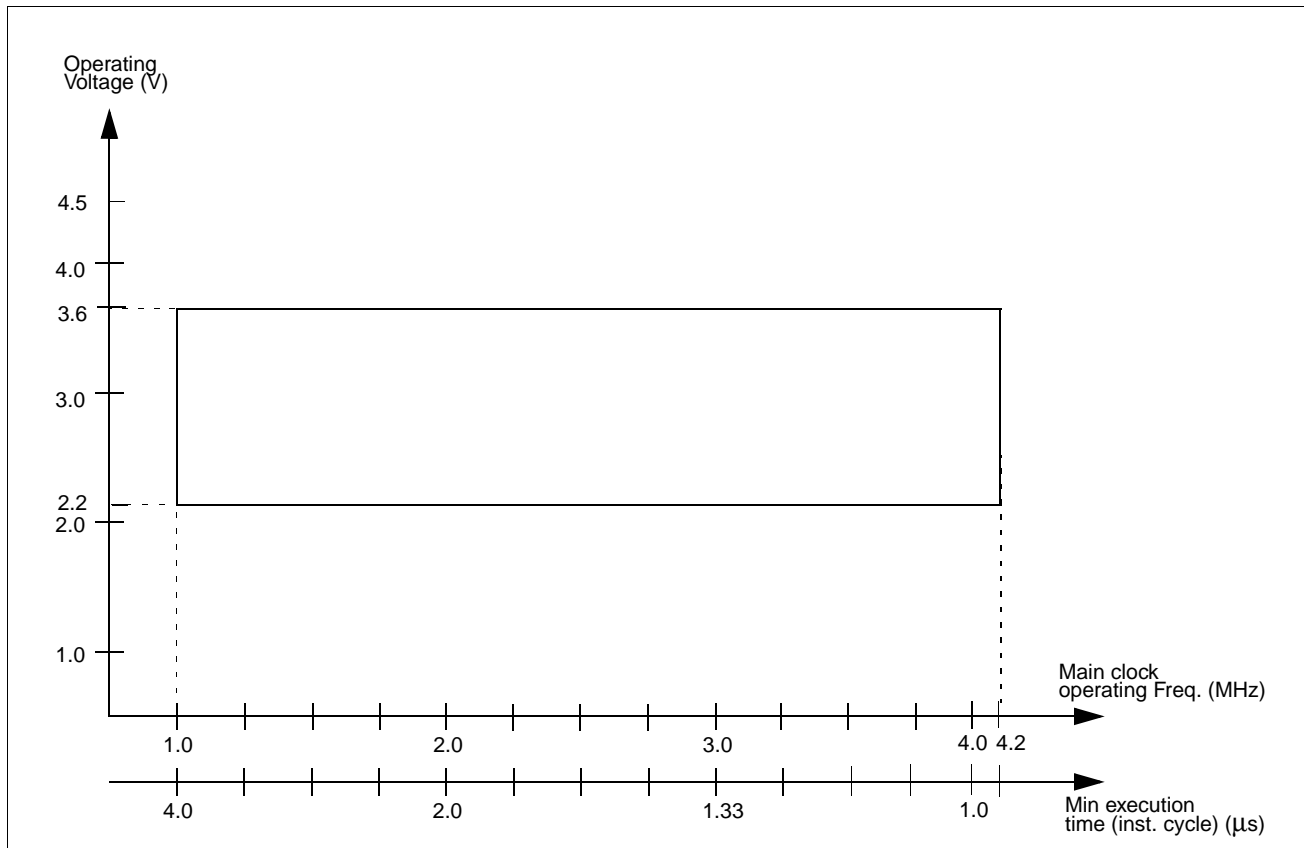

Operating Voltage vs. Main Clock Operating Frequency (MB89183L/185L)

“Operating Voltage vs. Main Clock Operating Frequency (MB89PV180/P185) and (MB89183L/185L)” indicate the operating frequency of the external oscillator at an instruction cycle of $4/F_{CH}$.

WARNING: The recommended operating conditions are required in order to ensure the normal operation of the semiconductor device. All of the device’s electrical characteristics are warranted when the device is operated within these ranges.

Always use semiconductor devices within their recommended operating condition ranges. Operation outside these ranges may adversely affect reliability and could result in device failure.

No warranty is made with respect to uses, operating conditions, or combinations not represented on the data sheet. Users considering application outside the listed conditions are advised to contact their FUJITSU representatives beforehand.

MB89180L Series

3. DC Characteristics

(1) Pin DC characteristics

($V_{CC} = +3.0\text{ V}$ for MB89183L/185L; $+5.0\text{ V}$ for MB89PV180/P185, $V_{SS} = 0.0\text{ V}$, $T_A = -40^\circ\text{C}$ to $+85^\circ\text{C}$)

Parameter	Symbol	Pin	Condition	Value			Unit	Remarks
				Min	Typ	Max		
"H" level input voltage	V_{IH}	P00 to P07, P10 to P17, P20 to P27	—	$0.7 V_{CC}$	—	$V_{CC} + 0.3$	V	CMOS input
	V_{IHS}	\overline{RST} , MODA, EC, SI, SCK, INT10 to INT13, INT20 to INT27		$0.8 V_{CC}$	—	$V_{CC} + 0.3$	V	Hysteresis input
"L" level input voltage	V_{IL}	P00 to P07, P10 to P17, P20 to P27	—	$V_{SS} - 0.3$	—	$0.3 V_{CC}$	V	CMOS input
	V_{ILS}	\overline{RST} , MODA, EC, SI, SCK, INT10 to INT13, INT20 to INT27		$V_{SS} - 0.3$	—	$0.2 V_{CC}$	V	Hysteresis input
Open-drain output pin application voltage	V_{D1}	P20 to P27, P31, P32, P40 to P47, P50 to P57	—	$V_{SS} - 0.3$	—	$V_{SS} + 4.0$	V	For MB89183L/185L, P20 to P27, P40 to P47, and P50 to P57 without pull-up resistor only
				$V_{SS} - 0.3$	—	$V_{SS} + 6.0$	—	For MB89PV180/P185, P20 to P27, P40 to P47, and P50 to P57 without pull-up resistor only
"H" level output voltage	V_{OH1}	P00 to P07, P10 to P17	$I_{OH} = -2.0\text{ mA}$	2.2	—	—	V	MB89183L/185L
			$I_{OH} = -2.0\text{ mA}$	2.4	—	—	V	MB89PV180/P185
	V_{OH2}	P30	$I_{OH} = -8.0\text{ mA}$	2.2	—	—	V	MB89183L/185L
			$I_{OH} = -6.0\text{ mA}$	4.0	—	—	V	MB89PV180/P185
"L" level output voltage	V_{OL}	P00 to P07, P10 to P17, P20, P22 to P25, P30 to P32, P40 to P47, P50 to P57	$I_{OL} = 1.8\text{ mA}$	—	—	0.4	V	
			$I_{OL} = 8.0\text{ mA}$	—	—	0.4	V	
	V_{OL3}	\overline{RST}	$I_{OL} = 4.0\text{ mA}$	—	—	0.4	V	MB89183L/185L
			$I_{OL} = 4.0\text{ mA}$	—	—	0.6	V	MB89PV180/P185

(Continued)

MB89180L Series

(Continued)

Parameter	Symbol	Pin	Condition	Value			Unit	Remarks
				Min	Typ	Max		
Input leakage current (High-Z output leakage current)	I _{LI1}	P00 to P07, P10 to P17, P30, MODA	0.45 V < V _I < V _{CC}	—	—	±5	μA	Without pull-up resistor
	I _{LI2}	P20 to P27, P31, P32, P40 to P47, P50 to P57	0.45 V < V _I < 4.0 V	—	—	±5	μA	Without pull-up resistor for MB89183L/185L
			0.45 V < V _I < 6.0 V	—	—	±5	μA	Without pull-up resistor for MB89PV180/P185
Pull-up resistance	R _{PULL}	P00 to P07, P10 to P17, P20 to P27, P40 to P47, P50 to P57, $\overline{\text{RST}}$	V _I = 0.0 V	25	50	100	kΩ	With pull-up resistor
Common output impedance	R _{VCOM}	COM0 to COM3	V1 to V3 = +3.0 V	—	—	2.5	kΩ	MB89183L/185L
			V1 to V3 = +5.0 V	—	—	2.5	kΩ	MB89PV180/P185
Segment output impedance	R _{VSEG}	SEG0 to SEG31	V1 to V3 = +3.0 V	—	—	15	kΩ	MB89183L/185L
			V1 to V3 = +5.0 V	—	—	15	kΩ	MB89PV180/P185
LCD divided resistance	R _{LCD}	—	Between V _{CC} and V _{SS}	300	500	750	kΩ	
LCD controller/driver leakage current	I _{LCDL}	V1 to V3, COM0 to COM3, SEG0 to SEG31	—	—	—	±1	μA	
Input capacitance	C _{IN}	Other than V _{CC} , V _{SS}	f = 1 MHz	—	10	—	pF	

Note : For pins which serve as the segment (SEG8 to SEG31) and ports (P40 to P47, P50 to P57 and P10 to P17), see the port parameter when these pins are used as ports and the segment parameter when they are used as segments.

MB89180L Series

(2) Power Supply Current Characteristics

($V_{SS} = 0.0\text{ V}$, $T_A = -40^\circ\text{C}$ to $+85^\circ\text{C}$)

Parameter	Symbol	Pin	Condition	Value			Unit	Remarks
				Min	Typ	Max		
Power supply current*	I _{CC1}	V _{CC}	F _{CH} = 4.2 MHz, V _{CC} = 3.0 V, t _{inst} = 4/F _{CH} , Main clock operation mode	—	1.3	2.5	mA	MB89183L, MB89185L
			F _{CH} = 4.2 MHz, V _{CC} = 5.0 V, t _{inst} = 4/F _{CH} , Main clock operation mode	—	3.0	4.5	mA	MB89PV180
	I _{CC2}		F _{CH} = 4.2 MHz, V _{CC} = 3.0 V, t _{inst} = 64/F _{CH} , Main clock operation mode	—	0.18	0.7	mA	MB89183L, MB89185L
				—	0.25	0.4	mA	MB89PV180
				—	0.85	1.4	mA	MB89P185
	I _{CCS1}		F _{CH} = 4.2 MHz, V _{CC} = 3.0 V, t _{inst} = 4/F _{CH} , Main clock sleep mode	—	0.32	1	mA	MB89183L, MB89185L
			F _{CH} = 4.2 MHz, V _{CC} = 5.0 V, t _{inst} = 4/F _{CH} , Main clock sleep mode	—	0.8	1.2	mA	MB89PV180, MB89P185
	I _{CCS2}		F _{CH} = 4.2 MHz, V _{CC} = 3.0 V, t _{inst} = 64/F _{CH} , Main clock sleep mode	—	0.1	0.3	mA	MB89183L, MB89185L
				—	0.2	0.3	mA	MB89PV180, MB89P185
	I _{CCL}		F _{CL} = 32.768 kHz, t _{inst} = 2/F _{CL} , T _A = +25°C, V _{CC} = 3.0 V, Subclock operation mode	—	0.05	0.1	mA	MB89183L, MB89185L, MB89PV180
				—	0.65	1.1	mA	MB89P185
	I _{CCSL}		F _{CL} = 32.768 kHz, t _{inst} = 2/F _{CL} , T _A = +25°C, V _{CC} = 3.0 V, Subclock sleep mode	—	10	20	μA	MB89183L, MB89185L
				—	25	50	μA	MB89PV180, MB89P185
	I _{CC_T}		F _{CL} = 32.768 kHz, T _A = +25°C, V _{CC} = 3.0 V, Watch mode	—	5	15	μA	MB89183L, MB89185L
				—	10	15	μA	MB89P185, MB89PV180
	I _{CC_H}		T _A = +25°C, V _{CC} = 3.0 V, Stop mode	—	1	10	μA	MB89183L, MB89185L
T _A = +25°C, V _{CC} = 5.0 V, Stop mode		—	0.1	10	μA	MB89PV180, MB89P185		

* : The power supply current is measured at the external clock, open output pins, and the external LCD dividing resistor (or external input for the reference voltage). In the case of the MB89PV180, the current consumed by the connected EPROM and ICE is not included.

MB89180L Series

4. AC Characteristics

(1) Reset Timing

(MB89183L/185L : $V_{CC} = +3.0\text{ V} \pm 10\%$, $V_{SS} = 0.0\text{ V}$, $T_A = -40^\circ\text{C}$ to $+85^\circ\text{C}$)
 (MB89PV180/P185 : $V_{CC} = +5.0\text{ V} \pm 10\%$, $V_{SS} = 0.0\text{ V}$, $T_A = -40^\circ\text{C}$ to $+85^\circ\text{C}$)

Parameter	Symbol	Condition	Value		Unit	Remarks
			Min	Max		
$\overline{\text{RST}}$ "L" pulse width	t_{ZLZH}	—	48 t_{CYL}	—	ns	

Notes : • t_{HCYL} is the main clock oscillator period.

- If the reset pulse applied to the external reset pin ($\overline{\text{RST}}$) does not meet the specifications, it may cause malfunctions. Use caution so that the reset pulse less than the specifications will not be fed to the external reset pin ($\overline{\text{RST}}$).

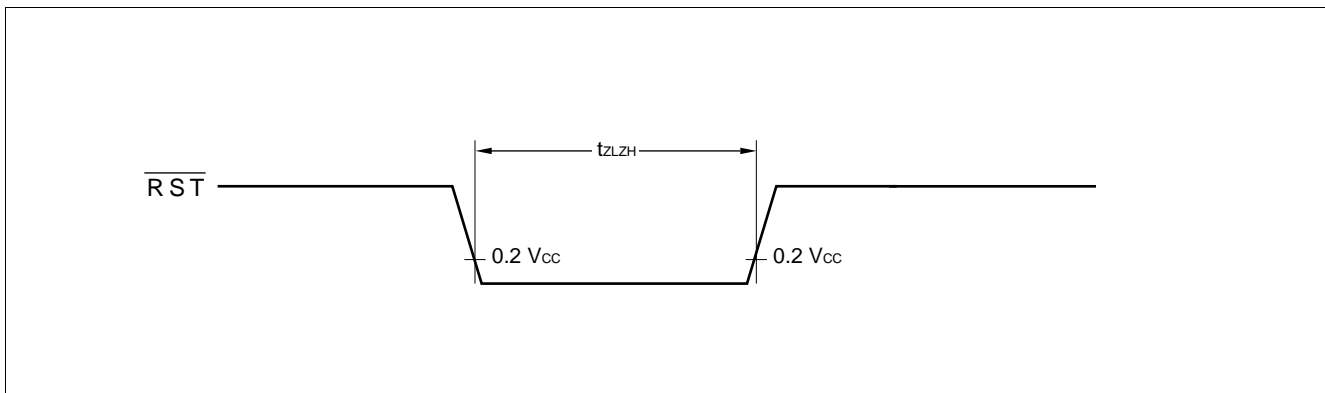

(2) Power-on Reset

($V_{SS} = 0.0\text{ V}$, $T_A = -40^\circ\text{C}$ to $+85^\circ\text{C}$)

Parameter	Symbol	Condition	Value		Unit	Remarks
			Min	Max		
Power supply rising time	t_{R}	—	—	50	ms	Power-on reset function only
Power supply cut-off time	t_{OFF}	—	1	—	ms	Due to repeated operations

Note : Make sure that power supply rises within the selected oscillation stabilization time. If power supply voltage needs to be varied in the course of operation, a smooth voltage rise is recommended.

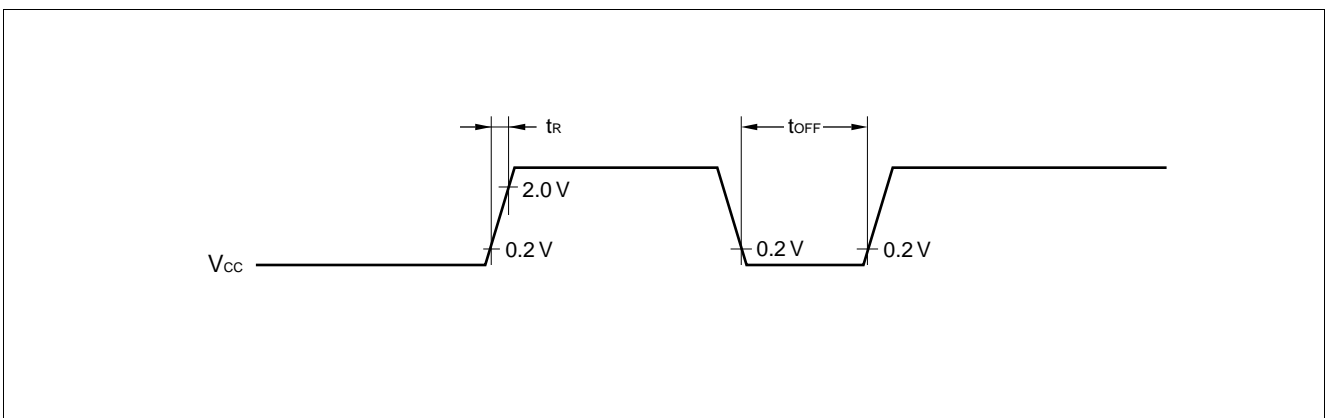

(3) Clock Timing

($V_{SS} = 0.0\text{ V}$, $T_A = -40^\circ\text{C}$ to $+85^\circ\text{C}$)

Parameter	Symbol	Pin	Value			Unit	Remarks
			Min	Typ	Max		
Clock frequency	F_{CH}	X0, X1	1	—	4.2	MHz	Main clock
	F_{CL}	X0A, X1A	—	32.768	—	kHz	Subclock
Clock cycle time	t_{HCYL}	X0, X1	238	—	1000	ns	Main clock
	t_{LCYL}	X0A, X1A	—	30.5	—	μs	Subclock
Input clock pulse width	P_{WH} P_{WL}	X0	20	—	—	ns	External clock
	P_{WHL} P_{WLL}	X0A	—	15.2	—	μs	
Input clock rising/falling time	t_{CR} t_{CF}	X0	—	—	10	ns	

Main Clock Timing and Conditions

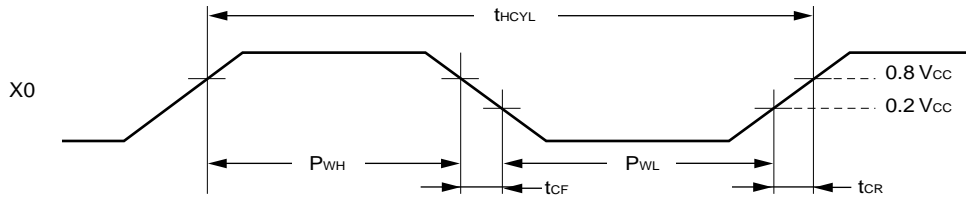

Main Clock Conditions

When a crystal or ceramic resonator is used

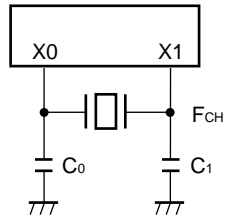

When an external clock is used

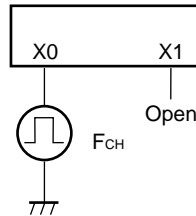

MB89180L Series

Subclock Timing and Conditions

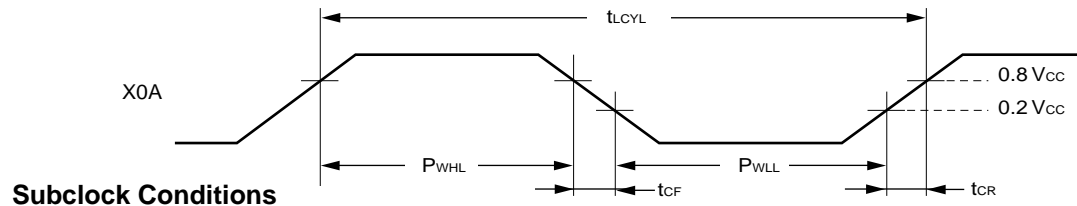

Subclock Conditions

When a crystal or ceramic oscillator is used

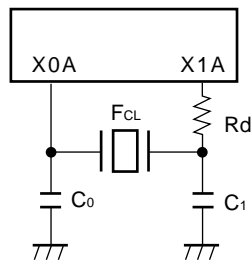

When an external clock is used

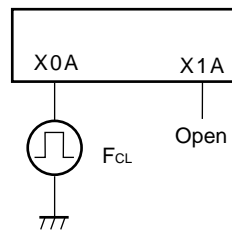

When the single-clock option is used

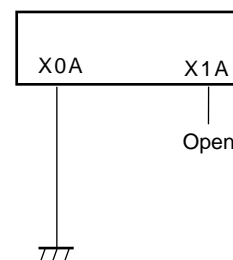

(4) Instruction Cycle

Parameter	Symbol	Value (typical)	Unit	Remarks
Instruction cycle (minimum execution time)	t _{inst}	4/F _{CH} , 8/F _{CH} , 16/F _{CH} , 64/F _{CH}	μs	(4/F _{CH}) t _{inst} = 1.0 μs at F _{CH} = 4 MHz
		2/F _{CL}	μs	t _{inst} = 61.036 μs at F _{CL} = 32.768 kHz

(5) Serial I/O Timing

(MB89183L/185L : $V_{CC} = +3.0\text{ V} \pm 10\%$, $V_{SS} = 0.0\text{ V}$, $T_A = -40^\circ\text{C}$ to $+85^\circ\text{C}$)
 (MB89PV180/P185 : $V_{CC} = +5.0\text{ V} \pm 10\%$, $V_{SS} = 0.0\text{ V}$, $T_A = -40^\circ\text{C}$ to $+85^\circ\text{C}$)

Parameter	Symbol	Pin	Condition	Value		Unit	Remarks
				Min	Max		
Serial clock cycle time	t_{SCYC}	SCK	Internal clock operation	$2 t_{inst}^*$	—	μs	
SCK $\downarrow \rightarrow$ SO time	t_{SLOV}	SCK, SO		-200	+200	ns	
Valid SI \rightarrow SCK \uparrow	t_{VSH}	SI, SCK		$1/2 t_{inst}^*$	—	μs	
SCK $\uparrow \rightarrow$ valid SI hold time	t_{SHIX}	SCK, SI		$1/2 t_{inst}^*$	—	μs	
Serial clock "H" pulse width	t_{SHSL}	SCK	External clock operation	$1 t_{inst}^*$	—	μs	
Serial clock "L" pulse width	t_{LSLH}			$1 t_{inst}^*$	—	μs	
SCK $\downarrow \rightarrow$ SO time	t_{SLOV}	SCK, SO		0	200	ns	
Valid SI \rightarrow SCK \uparrow	t_{VSH}	SI, SCK		$1/2 t_{inst}^*$	—	μs	
SCK $\uparrow \rightarrow$ valid SI hold time	t_{SHIX}	SCK, SI		$1/2 t_{inst}^*$	—	μs	

* : For information on t_{inst} , see "(4) Instruction Cycle."

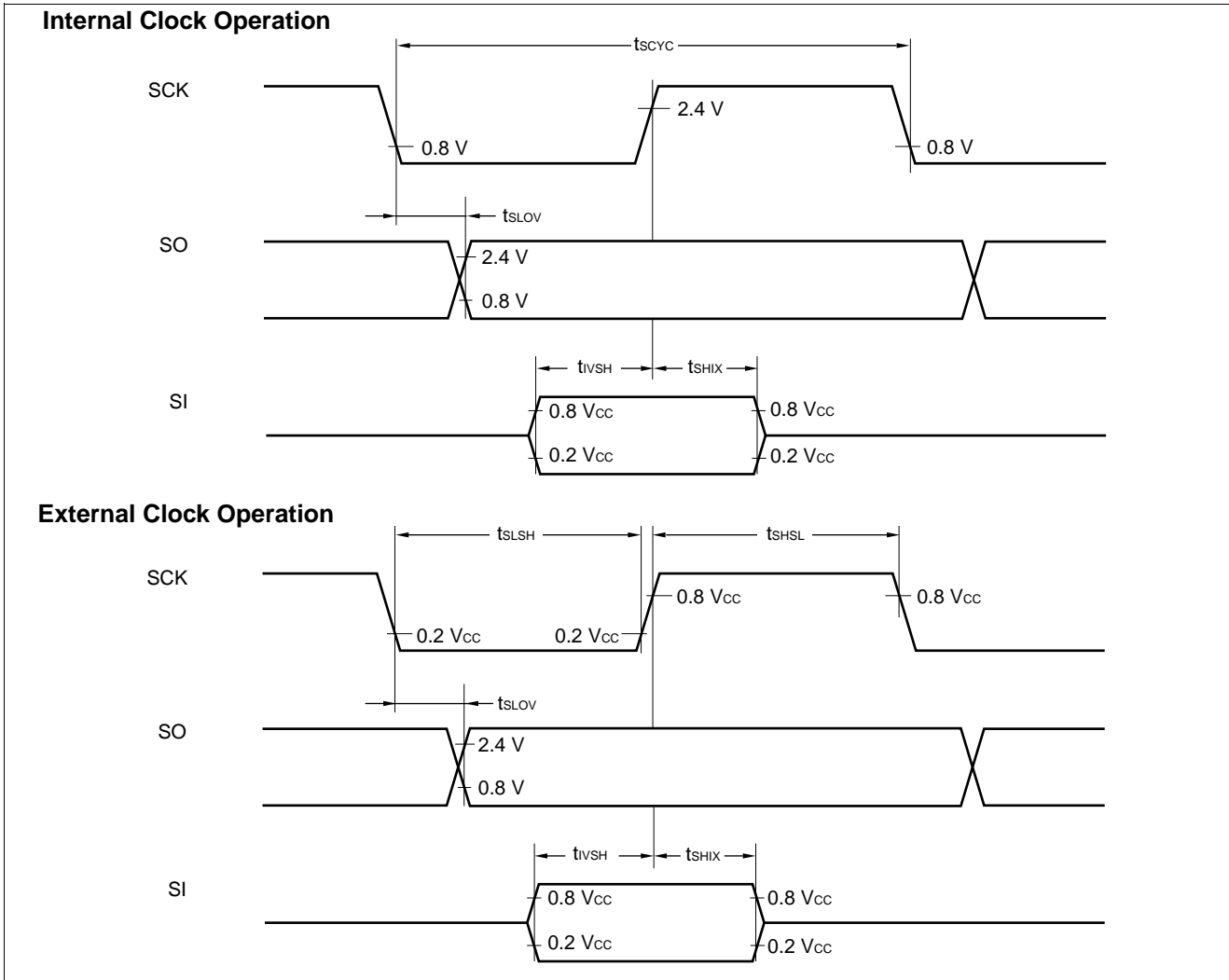

MB89180L Series

(6) Peripheral Input Timing

(MB89183L/185L : $V_{CC} = +3.0\text{ V} \pm 10\%$, $V_{SS} = 0.0\text{ V}$, $T_A = -40^\circ\text{C}$ to $+85^\circ\text{C}$)

(MB89PV180/P185 : $V_{CC} = +5.0\text{ V} \pm 10\%$, $V_{SS} = 0.0\text{ V}$, $T_A = -40^\circ\text{C}$ to $+85^\circ\text{C}$)

Parameter	Symbol	Pin	Value		Unit	Remarks
			Min	Max		
Peripheral input "H" pulse width 1	t_{ILIH1}	INT10 to INT13, EC	1 t_{inst}^*	—	μS	
Peripheral input "L" pulse width 1	t_{IHIL1}		1 t_{inst}^*	—	μS	
Peripheral input "H" pulse width 2	t_{ILIH2}	$\overline{\text{INT20}}$ to $\overline{\text{INT27}}$	2 t_{inst}^*	—	μS	
Peripheral input "L" pulse width 2	t_{IHIL2}		2 t_{inst}^*	—	μS	

* : For information on t_{inst} , see "(4) Instruction Cycle."

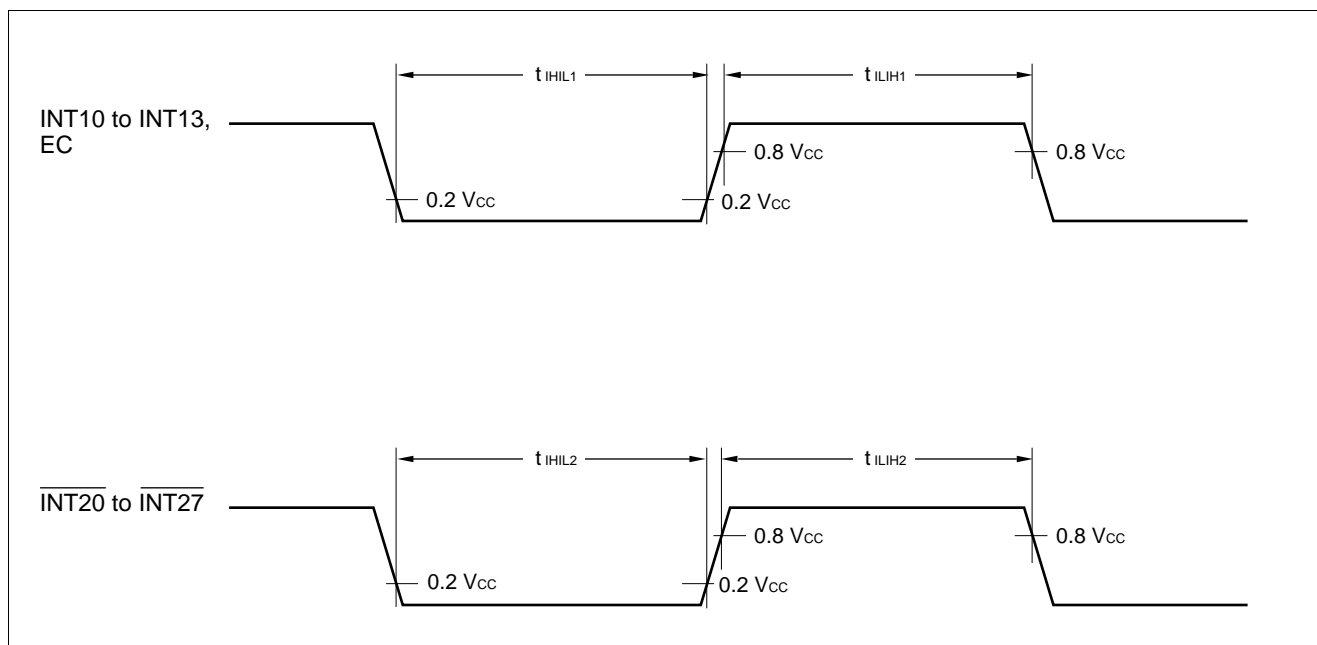

EXAMPLE CHARACTERISTICS

(1) "L" Level Output Voltage

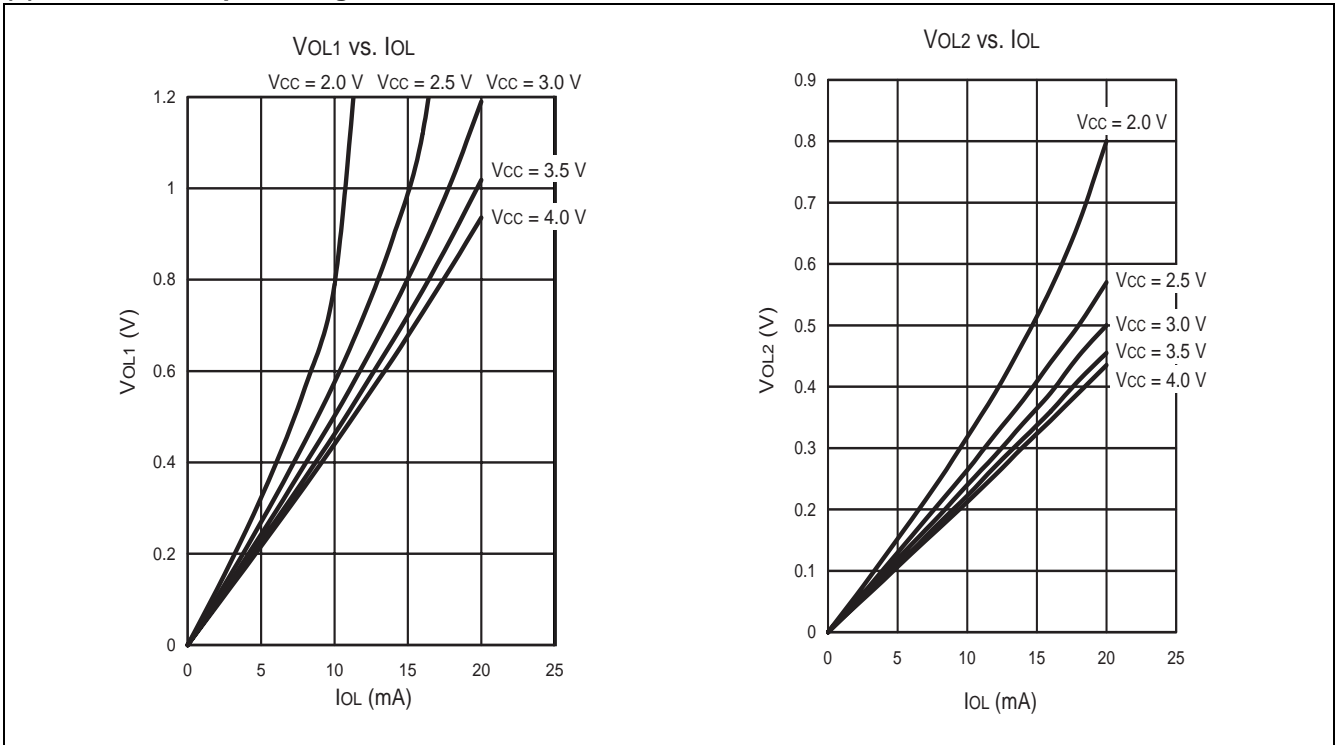

(2) "H" Level Output Voltage

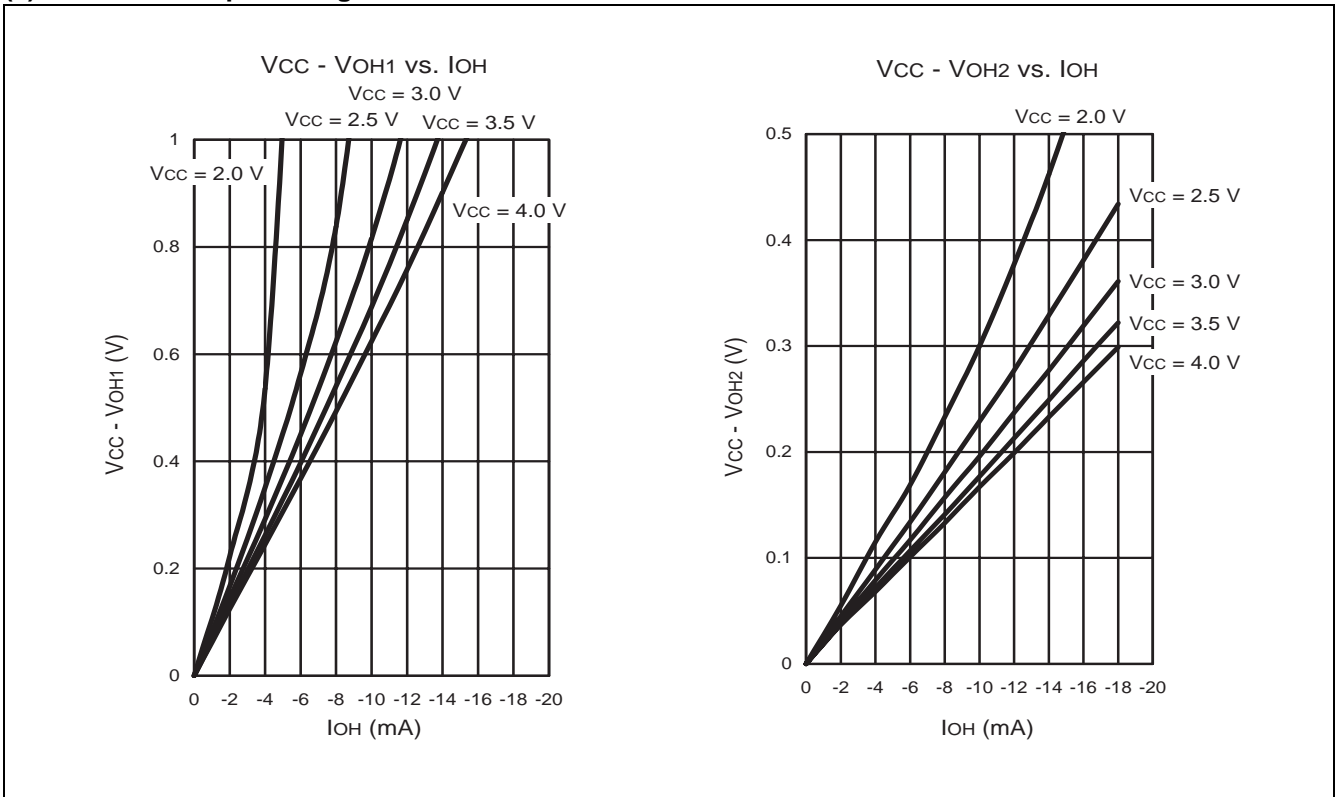

MB89180L Series

(3) "H" Level Input Voltage/"L" level Input Voltage

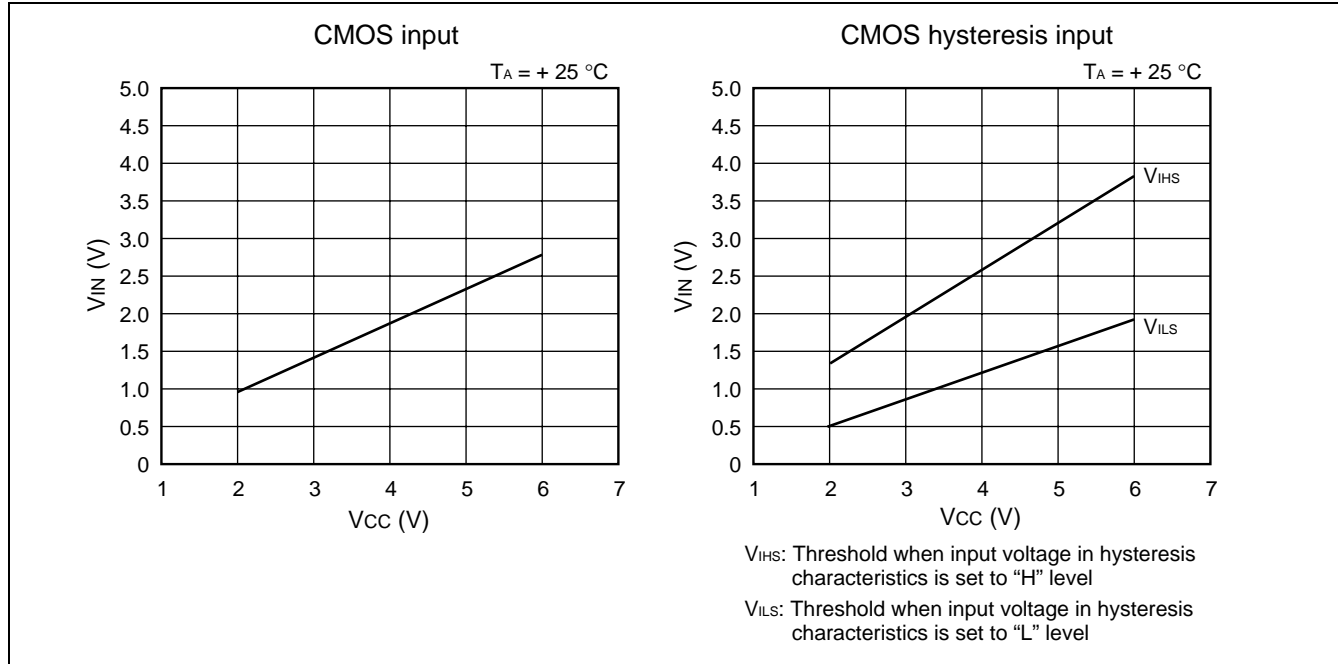

(4) Power Supply Current (External Clock)

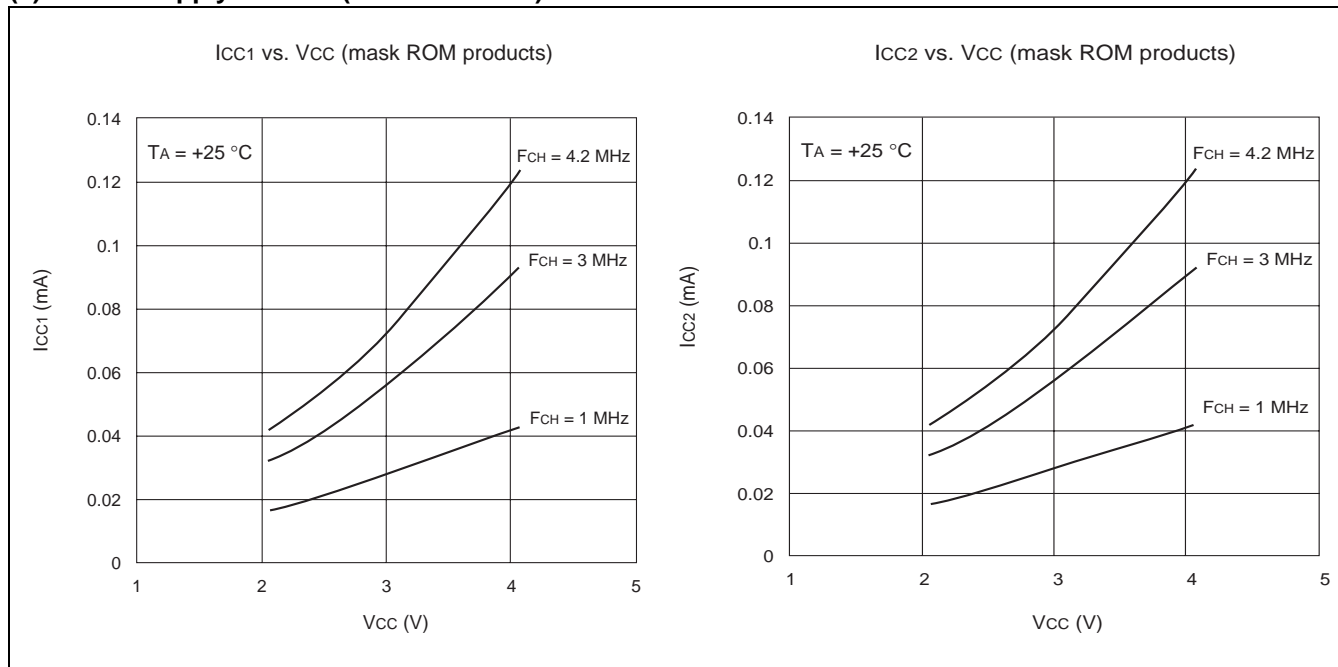

(Continued)

ICCS1 vs. VCC (mask ROM products)

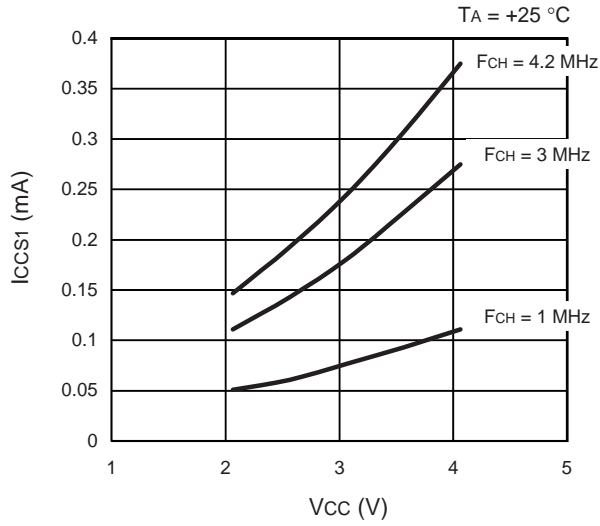

ICCS2 vs. VCC (mask ROM products)

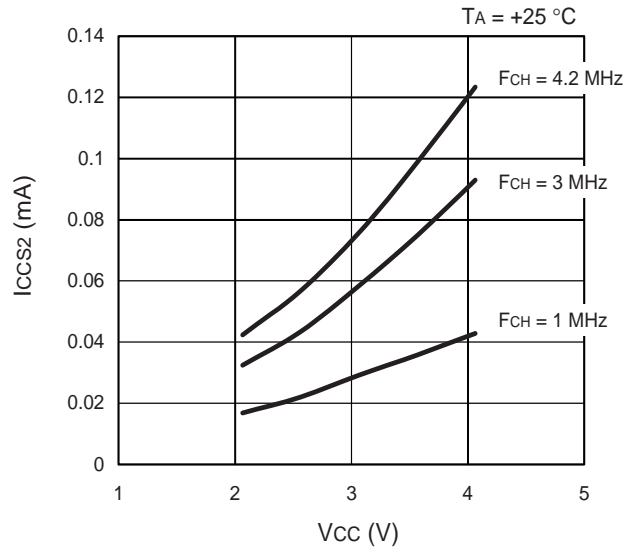

ICCT vs. VCC (mask ROM products)

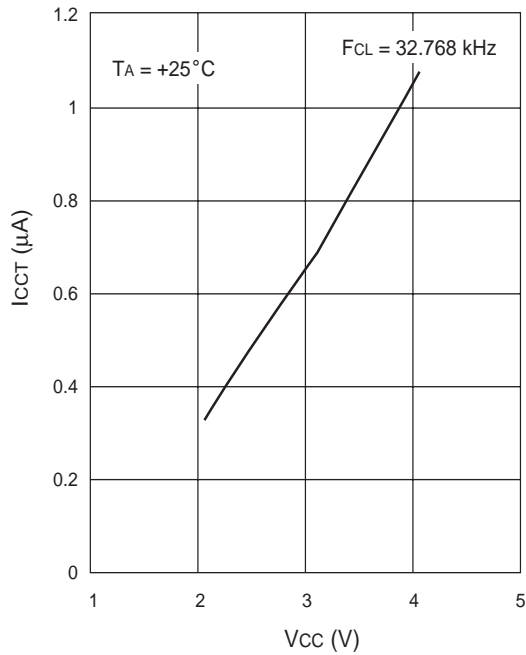

(Continued)

MB89180L Series

(Continued)

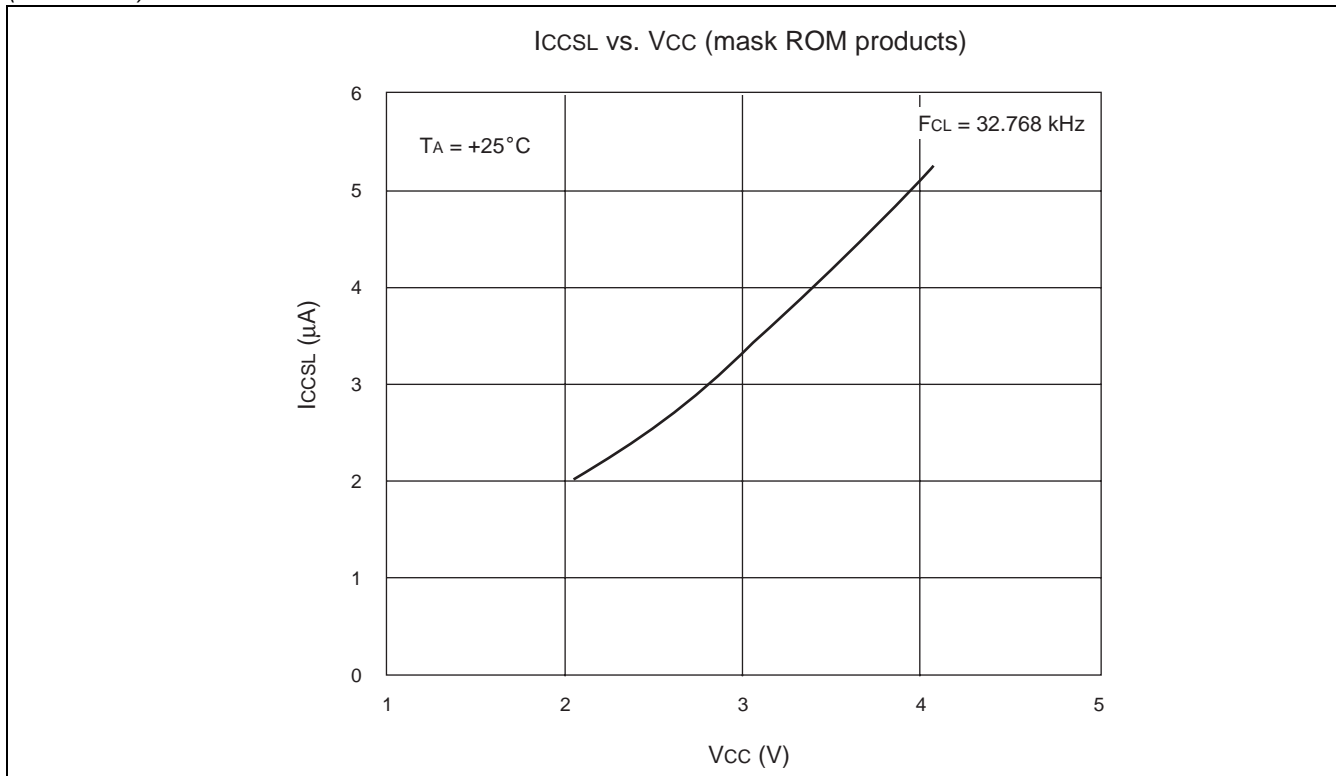

(5) Pull-up Resistance

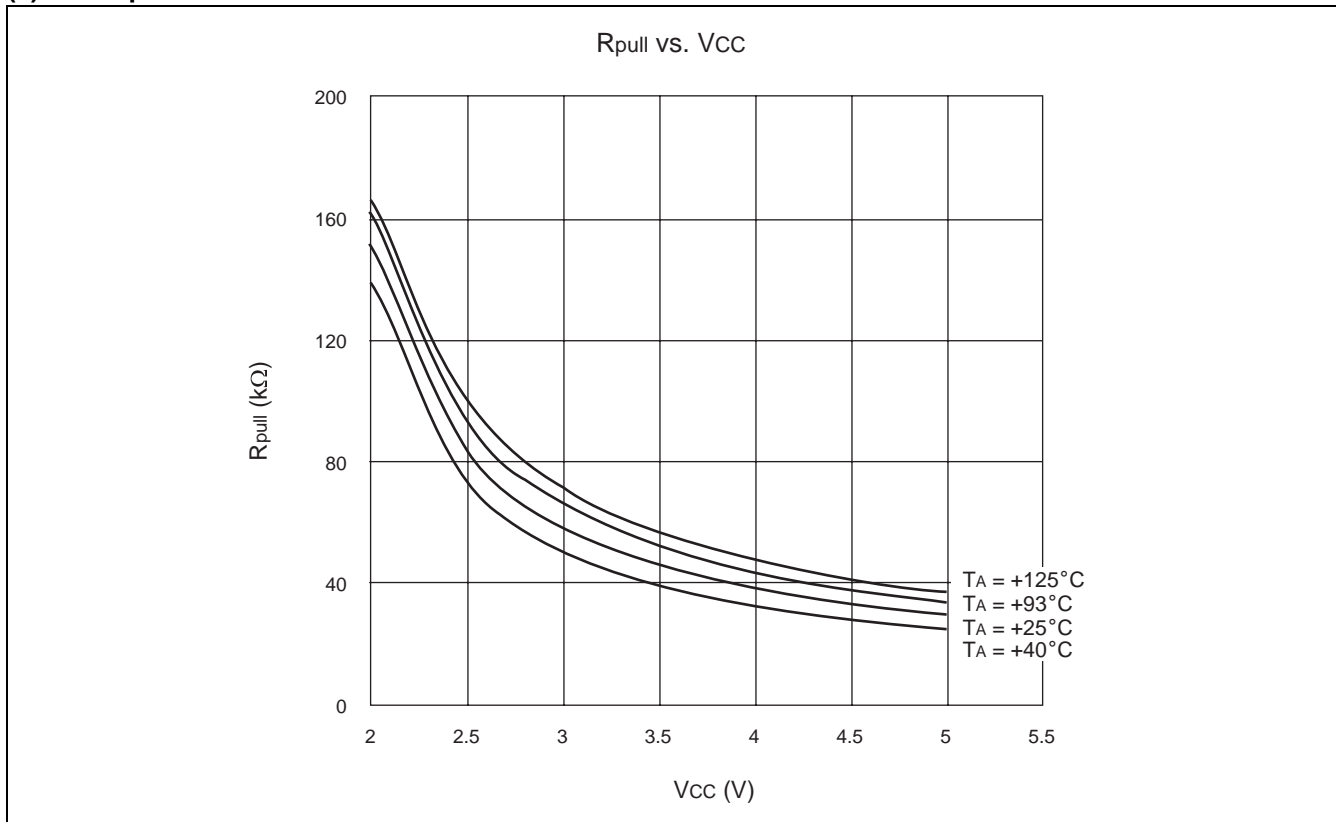

MB89180L Series

■ MASK OPTIONS

No.	Part number	MB89183L/185L	MB89P185	MB89PV180
	Specifying procedure	Specify when ordering masking	Set with EPROM programmer	Setting not possible
1	Pull-up resistors (PXX) P00 to P07, P10 to P17	Selectable per pin (The pull-up resistors for P10 to P17 are available only when these pins are not set as segment outputs.)	Can be set per pin (P10 to P17 are available only when segment output is not selected.)	Fixed to without pull-up resistor
2	Pull-up resistors (PXX) P40 to P47, P50 to P57	Selectable per pin (Available only when these pins are not set as segment outputs.)	Fixed to without pull-up resistor	Fixed to without pull-up resistor
3	Pull-up resistors (PXX) P20 to P27	Selectable per pin	Fixed to without pull-up resistor	Fixed to without pull-up resistor
4	Power-on reset (POR) With power-on reset Without power-on reset	Selectable	Selectable	Fixed to with power-on reset
5	Selection of oscillation stabilization time (OSC) • The initial value of the oscillation stabilization time for the main clock can be set by selecting the values of the WTM1 and WTM0 bits on the right.	Selectable OSC 0 : $2^2/F_{CH}$ 1 : $2^{12}/F_{CH}$ 2 : $2^{16}/F_{CH}$ 3 : $2^{18}/F_{CH}$	Selectable WTM1 WTM0 0 0 : $2^2/F_{CH}$ 0 1 : $2^{12}/F_{CH}$ 1 0 : $2^{16}/F_{CH}$ 1 1 : $2^{18}/F_{CH}$	Fixed to oscillation stabilization time of $2^{16}/F_{CH}$
6	Main clock oscillation type (XSL) Crystal or ceramic resonator	Crystal or ceramic	Crystal or ceramic	Crystal or ceramic
7	Reset pin output (RST) With reset output Without reset output	Selectable	Selectable	Fixed to with reset output
8	Clock mode selection (CLK) Dual-clock mode Single-clock mode	Selectable	Selectable	Fixed to dual-clock mode

(Continued)

MB89180L Series

(Continued)

No.	Part number	MB89183L/185L	MB89P185	MB89PV180
	Specifying procedure	Specify when ordering masking	Select by version number	Select by version number
9	LCD output pin configuration choices	Specify by the option combinations listed below	—	—
	SEG = 6: P40 to P47 segment output P50 to P57 segment output P10 to P17 segment output	Specify as SEG = 6	−101 : SEG 32 pins	−101 : SEG 32 pins
	SEG = 5: P40 to P47 segment output P50 to P57 segment output P10 to P13 segment output P14 to P17 port output	Specify as SEG = 5	−102 : SEG 28 pins	−102 : SEG 28 pins
	SEG = 4: P40 to P47 segment output P50 to P57 segment output P10 to P17 port output	Specify as SEG = 4	−103 : SEG 24 pins	−103 : SEG 24 pins
	SEG = 3: P40 to P47 segment output P50 to P53 segment output P54 to P57 port output P10 to P17 port output	Specify as SEG = 3	−104 : SEG 20 pins	−104 : SEG 20 pins
	SEG = 2: P40 to P47 segment output P50 to P57 port output P10 to P17 port output	Specify as SEG = 2	−105 : SEG 16 pins	−105 : SEG 16 pins
	SEG = 1: P40 to P43 segment output P44 to P47 port output P50 to P57 port output P10 to P17 port output	Specify as SEG = 1	−106 : SEG 12 pins	−106 : SEG 12 pins
	SEG = 0: P40 to P47 port output P50 to P57 port output P10 to P17 port output	Specify as SEG = 0	−107 : SEG 8 pins	−107 : SEG 8 pins

MB89180L Series

■ ORDERING INFORMATION

Part number	Package	Remarks
MB89183LPF MB89185LPF MB89P185PF-101 MB89P185PF-102 MB89P185PF-103 MB89P185PF-104 MB89P185PF-105 MB89P185PF-106 MB89P185PF-107	64-pin Plastic QFP (FPT-64P-M06)	
MB89183LPFM MB89185LPFM MB89P185PFM-101 MB89P185PFM-102 MB89P185PFM-103 MB89P185PFM-104 MB89P185PFM-105 MB89P185PFM-106 MB89P185PFM-107	64-pin Plastic QFP (FPT-64P-M09)	
MB89183LPFV MB89185LPFV	64-pin Plastic SQFP (FPT-64P-M03)	
MB89PV180CF-101 MB89PV180CF-102 MB89PV180CF-103 MB89PV180CF-104 MB89PV180CF-105 MB89PV180CF-106 MB89PV180CF-107	64-pin Ceramic MQFP (MQP-64C-P01)	

MB89180L Series

PACKAGE DIMENSIONS

64-pin Plastic SQFP
(FPT-64P-M03)

Note 1) * : These dimensions do not include resin protrusion.
 Note 2) Pins width and pins thickness include plating thickness.
 Note 3) Pins width do not include tie bar cutting remainder.

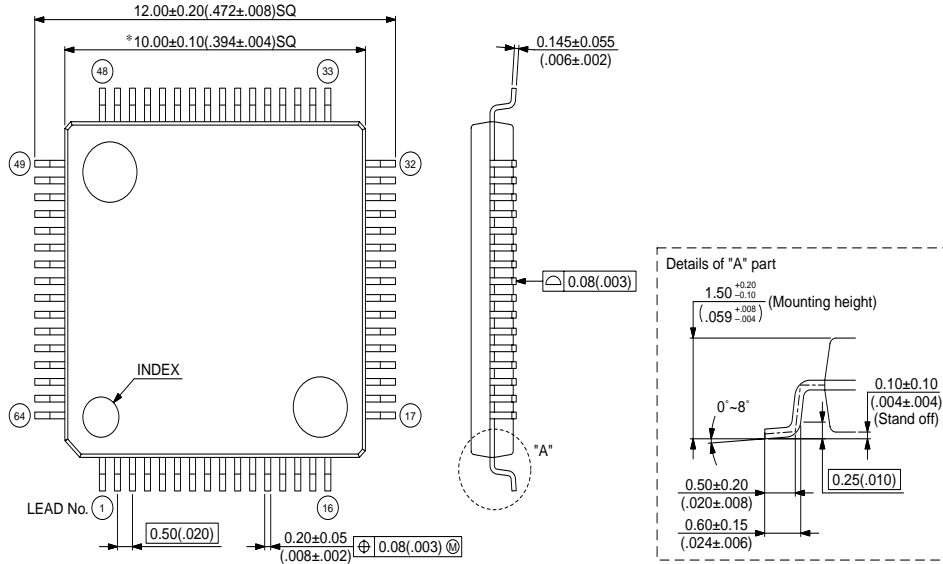

© 2003 FUJITSU LIMITED F64009S-c-5-8

Dimensions in mm (inches)

64-pin Plastic QFP
(FPT-64P-M06)

Note 1) * : These dimensions do not include resin protrusion.
 Note 2) Pins width and pins thickness include plating thickness.
 Note 3) Pins width do not include tie bar cutting remainder.

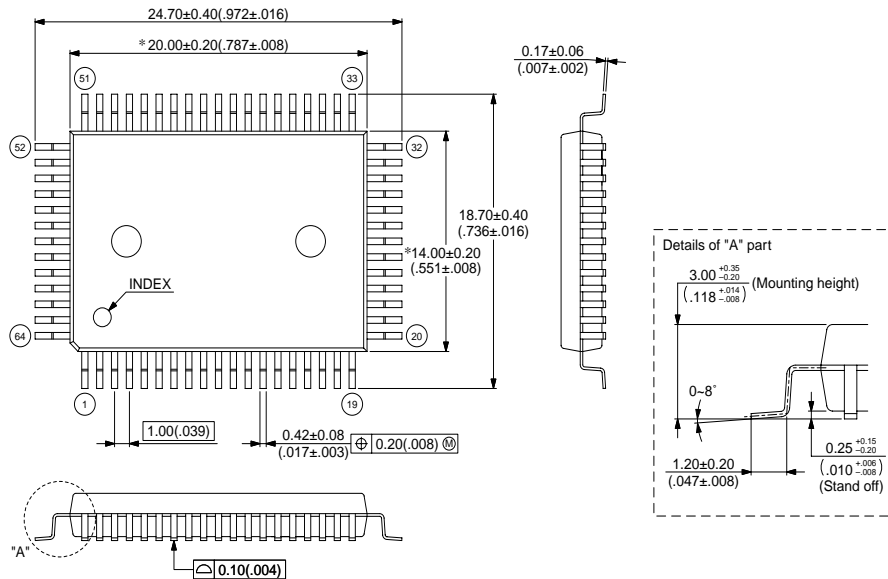

© 2003 FUJITSU LIMITED F64013S-c-5-5

Dimensions in mm (inches)

(Continued)

MB89180L Series

(Continued)

64-pin Plastic QFP
(FPT-64P-M09)

Note 1) * : These dimensions do not include resin protrusion.
 Note 2) Pins width and pins thickness include plating thickness.
 Note 3) Pins width do not include tie bar cutting remainder.

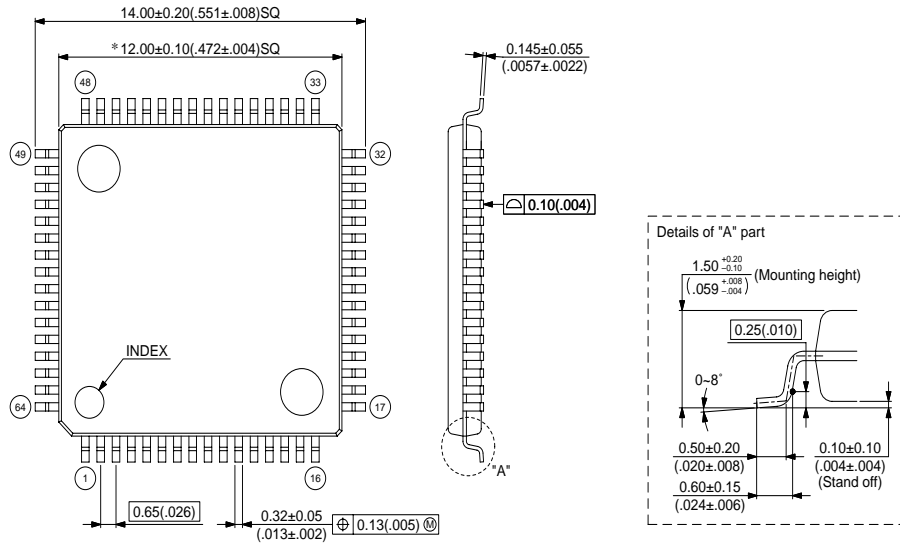

© 2003 FUJITSU LIMITED F64018S-c-3-5

Dimensions in mm (inches)

64-pin Ceramic MQFP
(MQP-64C-P01)

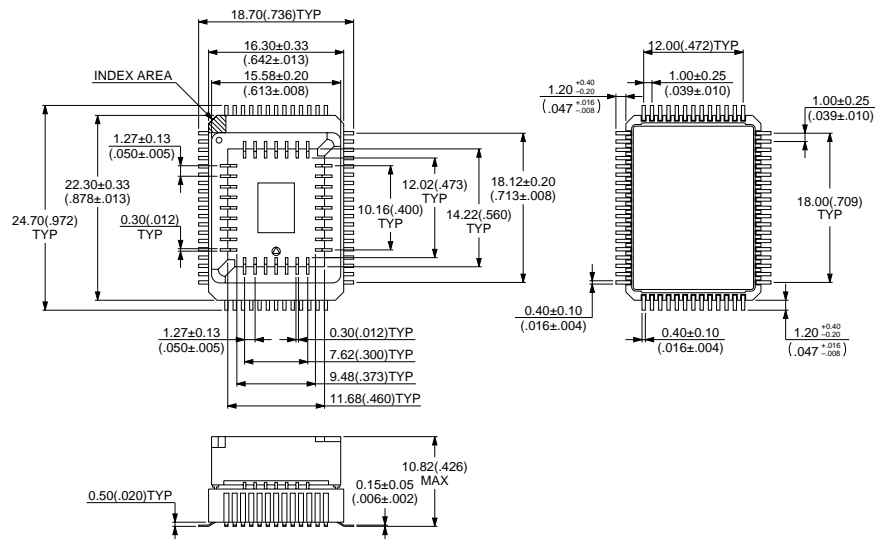

© 1994 FUJITSU LIMITED M64004SC-1-3

Dimensions in mm (inches)

FUJITSU LIMITED

All Rights Reserved.

The contents of this document are subject to change without notice. Customers are advised to consult with FUJITSU sales representatives before ordering.

The information, such as descriptions of function and application circuit examples, in this document are presented solely for the purpose of reference to show examples of operations and uses of Fujitsu semiconductor device; Fujitsu does not warrant proper operation of the device with respect to use based on such information. When you develop equipment incorporating the device based on such information, you must assume any responsibility arising out of such use of the information. Fujitsu assumes no liability for any damages whatsoever arising out of the use of the information.

Any information in this document, including descriptions of function and schematic diagrams, shall not be construed as license of the use or exercise of any intellectual property right, such as patent right or copyright, or any other right of Fujitsu or any third party or does Fujitsu warrant non-infringement of any third-party's intellectual property right or other right by using such information. Fujitsu assumes no liability for any infringement of the intellectual property rights or other rights of third parties which would result from the use of information contained herein.

The products described in this document are designed, developed and manufactured as contemplated for general use, including without limitation, ordinary industrial use, general office use, personal use, and household use, but are not designed, developed and manufactured as contemplated (1) for use accompanying fatal risks or dangers that, unless extremely high safety is secured, could have a serious effect to the public, and could lead directly to death, personal injury, severe physical damage or other loss (i.e., nuclear reaction control in nuclear facility, aircraft flight control, air traffic control, mass transport control, medical life support system, missile launch control in weapon system), or (2) for use requiring extremely high reliability (i.e., submersible repeater and artificial satellite).

Please note that Fujitsu will not be liable against you and/or any third party for any claims or damages arising in connection with above-mentioned uses of the products.

Any semiconductor devices have an inherent chance of failure. You must protect against injury, damage or loss from such failures by incorporating safety design measures into your facility and equipment such as redundancy, fire protection, and prevention of over-current levels and other abnormal operating conditions.

If any products described in this document represent goods or technologies subject to certain restrictions on export under the Foreign Exchange and Foreign Trade Law of Japan, the prior authorization by Japanese government will be required for export of those products from Japan.