

GPTK2126

PHASE CONTROLLED SCR

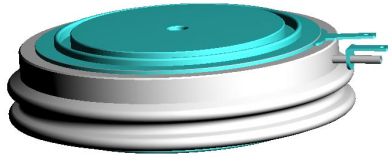

High reliability operation
DC power supply
AC drives

| | |
|------------------------|---------------|
| VOLTAGE UP TO | 1600 V |
| AVERAGE CURRENT | 1260 A |
| SURGE CURRENT | 12 kA |

BLOCKING CHARACTERISTICS

| Characteristic | Conditions | Value |
|----------------|-----------------------------------------|-------------------------------------------------------------------|
| VRRM | Repetitive peak reverse voltage | 1600 V |
| VRSM | Non-repetitive peak reverse voltage | 1700 V |
| VDRM | Repetitive peak off-state voltage | 1600 V |
| IDRM | Repetitive peak off-state current, max. | VDRM, single phase, half wave, T _j = T _{jmax} |
| IRRM | Repetitive peak reverse current, max. | VRRM, single phase, half wave, T _j = T _{jmax} |

ON-STATE CHARACTERISTICS

| | | | |
|---------------------|------------------------------------------|------------------------------------------------------------------------------------------|-----------------------|
| I _{T(AV)} | Average on-state current | Sine wave, 180° conduction, Th = 55 °C | 1260 A |
| I _{T(RMS)} | R.M.S. on-state current | Sine wave, 180° conduction, Th = 55 °C | 1979 A |
| I _{TSM} | Surge on-state current | Non rep. half sine wave, 50 Hz, V _R = 0 V, T _j = T _{jmax} | 12 kA |
| I ² t | I ² t for fusing coordination | | 720 kA ² s |
| V _{T(TO)} | Threshold voltage | T _j = T _{jmax} | 0,91 V |
| r _T | On-state slope resistance | T _j = T _{jmax} | 0,23 mΩ |
| V _{TM} | Peak on-state voltage, max | On-state current I _T = 2510 A , T _j = 25 °C | 1,49 V |
| I _H | Holding current, max | T _j = 25 °C | 150 mA |
| I _L | Latching current, typ | T _j = 25 °C | 300 mA |

TRIGGERING CHARACTERISTICS

| | | | |
|--------------------|--------------------------------|---------------------------------------------------------------|--------|
| V _{GT} | Gate trigger voltage | T _j = 25 °C, V _D = 5 V | 2,5 V |
| I _{GT} | Gate trigger current | T _j = 25 °C, V _D = 5 V | 250 mA |
| V _{GD} | Non-trigger voltage | V _D = 67% VRRM, T _j = T _{jmax} | 0,15 V |
| P _{GM} | Peak gate power dissipation | Pulse width 0.5 ms | 100 W |
| P _{G(AV)} | Average gate power dissipation | | 5 W |
| I _{FGM} | Peak gate current | | 30 A |
| V _{FGM} | Peak gate voltage (forward) | | 12 V |
| V _{RGM} | Peak gate voltage (reverse) | | 3 V |

SWITCHING CHARACTERISTICS

| | | | |
|----------------|--------------------------------------------|-------------------------------------------------------------------------------------------------------------------------------------------------------|-----------|
| di/dt | Critical rate of rise of on-state current | T _j = T _{jmax} | 200 A/μs |
| dV/dt | Critical rate of rise of off-state voltage | T _j = T _{jmax} | 1000 V/μs |
| t _q | Turn-off time, typ | T _j = T _{jmax} , I _T = 800 A, di/dt = -12.5 A/μs V _R = 100 V, V _D = 67% VDRM, dV/dt = 20 V/μs | 300 μs |

THERMAL AND MECHANICAL CHARACTERISTICS

| | | | |
|----------------------|---------------------------------------|--------------------|--------------|
| R _{th(j-c)} | Thermal resistance (junction to case) | Double side cooled | 0,033 °C/W |
| R _{th(c-h)} | Thermal resistance (case to heatsink) | Double side cooled | 0,001 °C/W |
| T _{jmax} | Max operating junction temperature | | 125 °C |
| T _{stg} | Storage temperature | | -40 / 125 °C |
| F | Clamping force ± 10% | | 15 kN |
| | Mass | | 320 g |

Current rating - sine wave

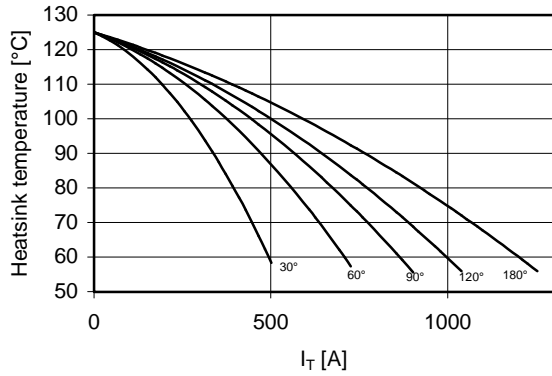

Power loss - sine wave

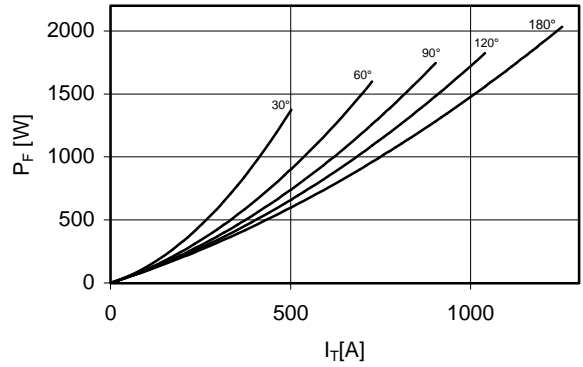

Maximum surge current d.s. cooled

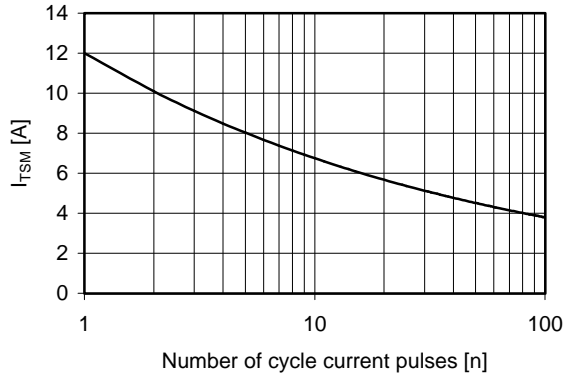

On-state voltage drop

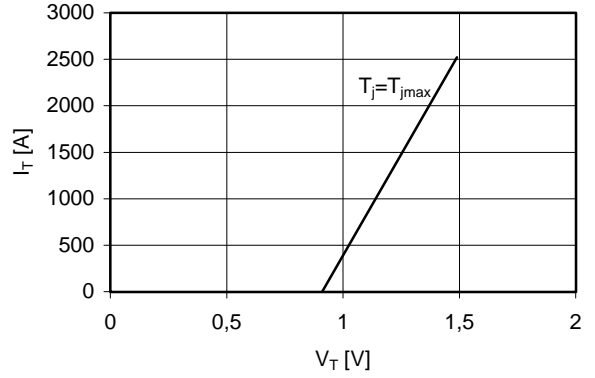

Thermal impedance (j-c)

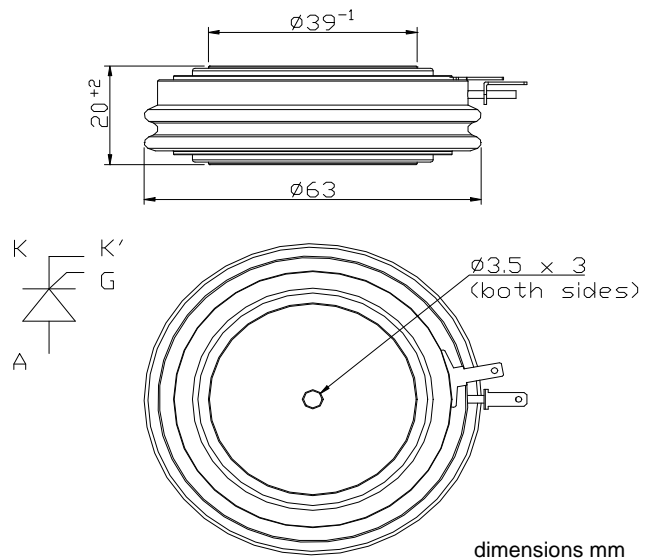
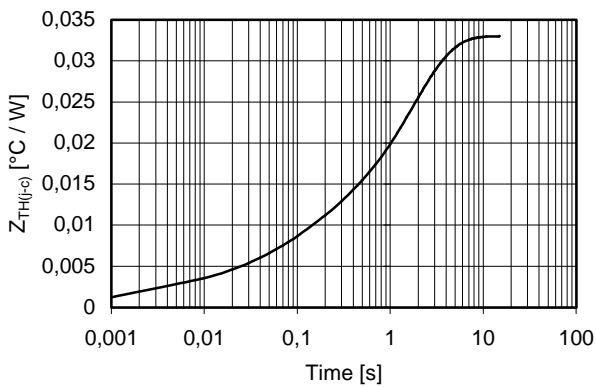

In the interest of product improvement Green Power Solutions reserves the right to change any specification given in this data sheet without notice.