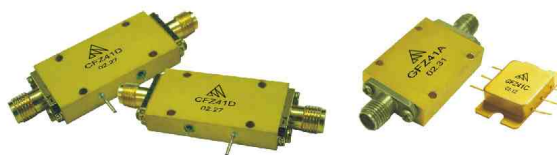
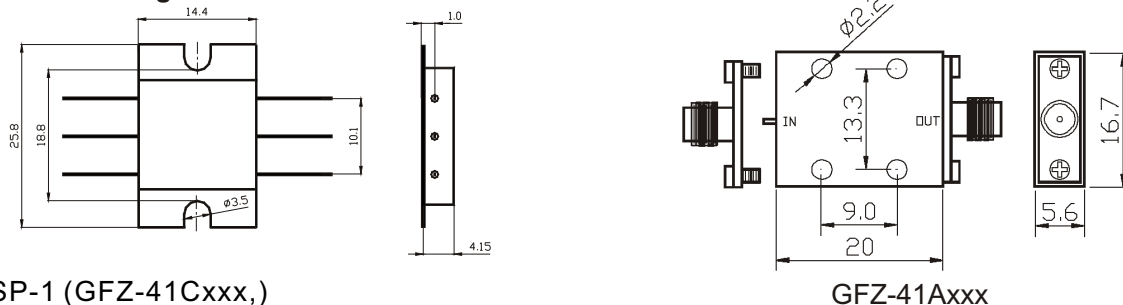

Features

- Thin-Thick film construction
- NO DC power (except GFZ-41D)
- Hermetic or removable SMA package available
- Custom product available

Ordering Information

Model	Description	package
GFZ-41Axxx	Passive comb generator	Removable SMA connectors
GFZ-41Cxxx	Passive comb generator	Hermetic SP-1 package
GFZ-41Dxxx	Active comb generator	Removable SMA connectors
GFZ-41Exxx	Active comb generator	Removable SMA connectors

1. GFZ-41A,GFZ-41C Passive Comb Generator
Outline Drawings

SP-1 (GFZ-41Cxxx,)

GFZ-41Axxx

Absolute Maximum Ratings

- Input power : 1W
- Storage Temp:+ 125°C

Specifications (Impedance :50 Ω ,Temp:25°C)

SMA Connectors		GFZ-41A100	GFZ-41A200	GFZ-41A500
SP-1 Package		GFZ-41C100	GFZ-41C200	GFZ-41C500
Input Frequency(MHz)		100	200	500
Input Power(dBm)		27	27	27
Output power Min(dBm)	Up to 4GHz	-15	-10	0
	4~8GHz	-35	-25	-15
	8~12GHz	----	-35	-25
Output power variation/ Temp *(dB), Typ		±2	±2	±2

*: Temp Range:-55°C~+85°C

GFZ41 Passive Comb Generator

BOWEI

2. GFZ-41D, GFZ-41E Active Comb Generator

Typical Performance

Outline Drawing

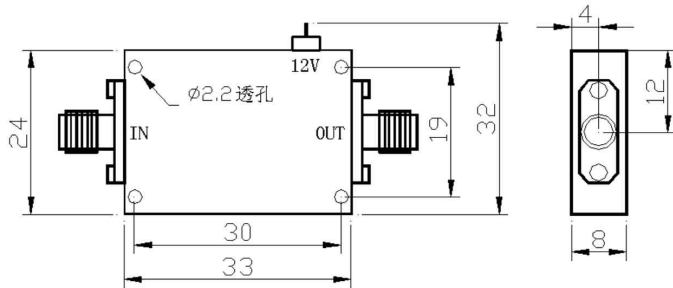

GFZ-41Dxxx

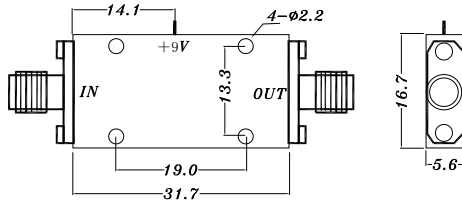

GFZ-41Exxx

Absolute Maximum Ratings

- Input Power : 20mW
- Storage Temp : + 85°C

Specifications($P_{in}=+10\text{dBm}$, $T_A=25^\circ\text{C}$)

	GFZ-41D50	GFZ-41D100	GFZ-41D200	GFZ-41E500	
Input Frequency(MHz)	50	100	200	500	
Input Power(dBm)	10	10	10	10	
Min output power (dBm)	Up to 4GHz	-20	-15	-10	-5
	4~8GHz	-40	-35	-25	-10
	8~12GHz	-	-	-35	-15
	12~18GHz	-	-	-	-25
Power Supply (V)	12	12	12	9	
Current(mA)	200	200	200	200	
Output Power Variation/Temp * (dB), Typ	± 2.5	± 2.5	± 2.5	± 2.5	

*: Temp Range: -40°C ~ +85°C

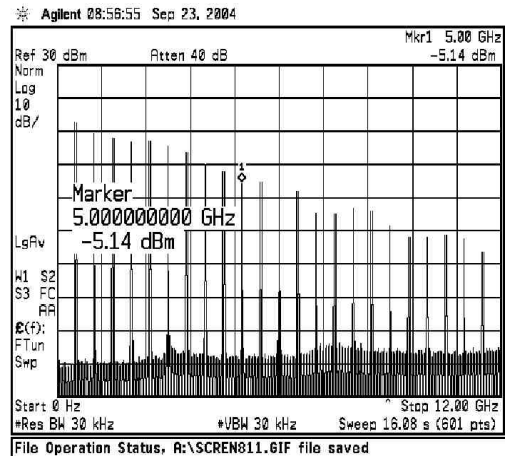

Fin=500MHz

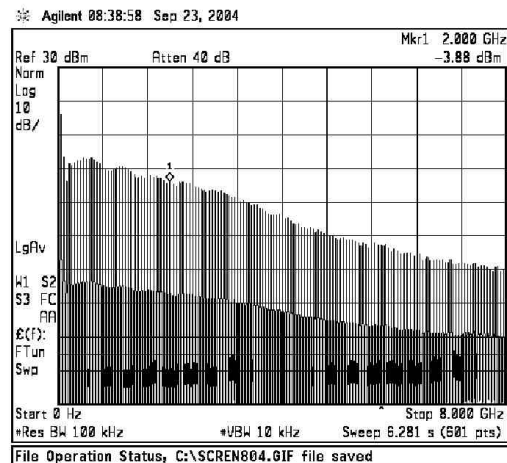

Fin=50MHz

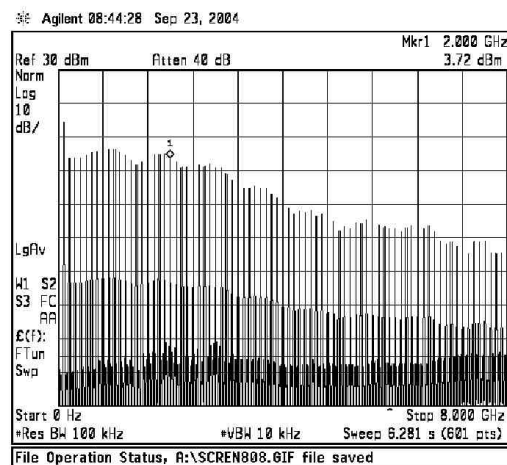

Fin=100MHz