

# SKKT 460, SKKH 460



**SEMIPACK<sup>®</sup> 5**

## Thyristor / Diode Modules

**SKKT 460**

**SKKH 460**

### Features

- Heat transfer through aluminium nitride ceramic insulated metal baseplate
- Precious metal pressure contacts for high reliability
- UL recognized, file no. E63532

### Typical Applications

- AC motor softstarters
- Input converters for AC inverter drives
- DC motor control (e.g. for machine tools)
- Temperature control (e.g. for ovens, chemical processes)
- Professionals light dimming (studios, theaters)

- 1) see assembly instructions
- 2) screws must be lubricated

$V_{RSM}$ V	$V_{RRM}, V_{DRM}$ V	$I_{TRMS} = 800$ A (maximum value for continuous operation) $I_{TAV} = 460$ A (sin. 180; $T_c = 85$ °C)	
1700	1600	SKKT 460/16E	SKKH 460/16E
2100	2000	SKKT 460/20E H4	SKKH 460/20E H4
2300	2200	SKKT 460/22E H4	SKKH 460/22E H4

Symbol	Conditions	Values	Units
$I_{TAV}$	sin. 180; $T_c = 85$ (100) °C;	460 (335)	A
$I_{TSM}$	$T_{vj} = 25$ °C; 10 ms $T_{vj} = 130$ °C; 10 ms	18000 15500	A
$i^2t$	$T_{vj} = 25$ °C; 8,3 .. 10 ms $T_{vj} = 130$ °C; 8,3 ... 10 ms	1620000 1200000	A <sup>2</sup> s
$V_T$	$T_{vj} = 25$ °C; $I_T = 1400$ A	max. 1,6	V
$V_{T(TO)}$	$T_{vj} = 130$ °C	max. 0,88	V
$r_T$	$T_{vj} = 130$ °C	max. 0,45	mΩ
$I_{DD}, I_{RD}$	$T_{vj} = 130$ °C; $V_{RD} = V_{RRM}; V_{DD} = V_{DRM}$	max. 240	mA
$t_{gd}$	$T_{vj} = 25$ °C; $I_G = 1$ A; $di_G/dt = 1$ A/μs	1	μs
$t_{gr}$	$V_D = 0,67 * V_{DRM}$	2	μs
$(di/dt)_{cr}$	$T_{vj} = 130$ °C	max. 250	A/μs
$(dv/dt)_{cr}$	$T_{vj} = 130$ °C	max. 1000	V/μs
$t_q$	$T_{vj} = 130$ °C,	100 .. 200	μs
$I_H$	$T_{vj} = 25$ °C; typ. / max.	150 / 500	mA
$I_L$	$T_{vj} = 25$ °C; $R_G = 33$ Ω; typ. / max.	300 / 2000	mA
$V_{GT}$	$T_{vj} = 25$ °C; d.c.	min. 3	V
$I_{GT}$	$T_{vj} = 25$ °C; d.c.	min. 200	mA
$V_{GD}$	$T_{vj} = 130$ °C; d.c.	max. 0,25	V
$I_{GD}$	$T_{vj} = 130$ °C; d.c.	max. 10	mA
$R_{th(j-c)}$	cont.; per thyristor / per module	0,072 / 0,035	K/W
$R_{th(j-c)}$	sin. 180°; per thyristor / per module	0,074 / 0,037	K/W
$R_{th(j-c)}$	rec. 120°; per thyristor / per module	0,078 / 0,039	K/W
$R_{th(c-s)}$	per thyristor / per module	0,02 / 0,01	K/W
$T_{vj}$		- 40 ... + 130	°C
$T_{stg}$		- 40 ... + 125	°C
$V_{isol}$	a.c. 50 Hz; r.m.s.; 1 s / 1 min.	3600 / 3000	V~
$V_{isol}$	a.c. 50 Hz; r.m.s.; 1 s / 1 min. for SKK...H4	4800 / 4000	V~
$M_s$	to heatsink	5 ± 15% <sup>1)</sup>	Nm
$M_t$	to terminals	12 ± 15% <sup>2)</sup>	Nm
$a$		5 * 9,81	m/s <sup>2</sup>
$m$	approx.	1400	g
Case	SKKT SKKH	A 60b A 66b	



SKKT

SKKH

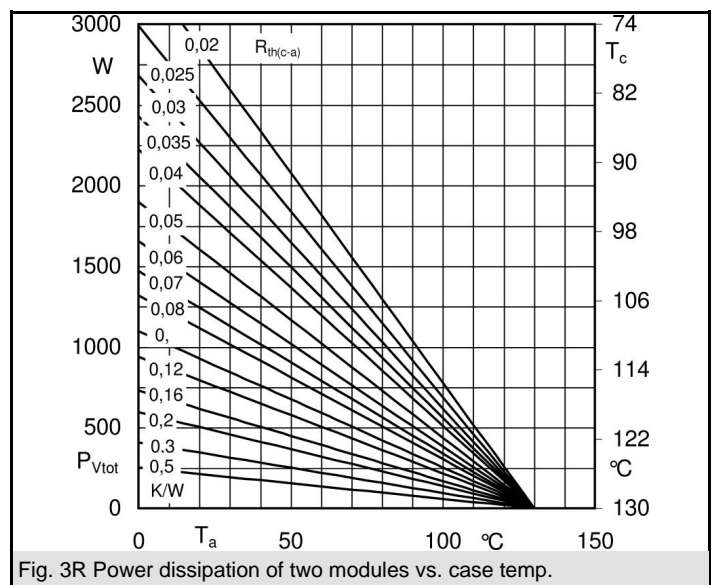
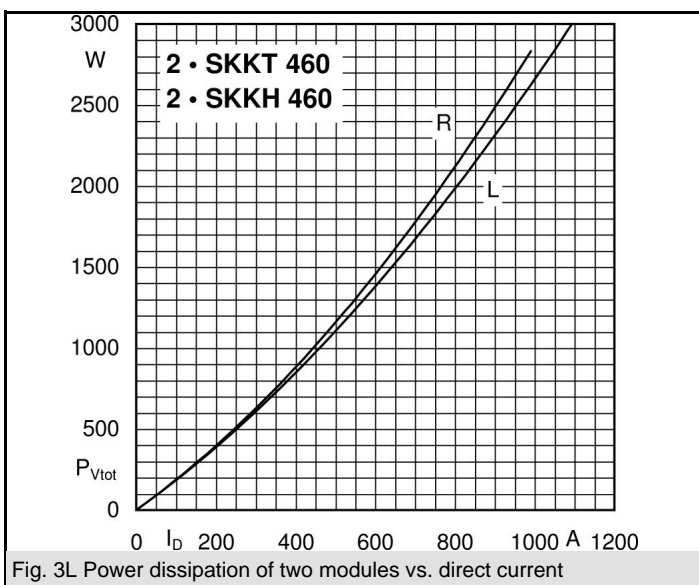
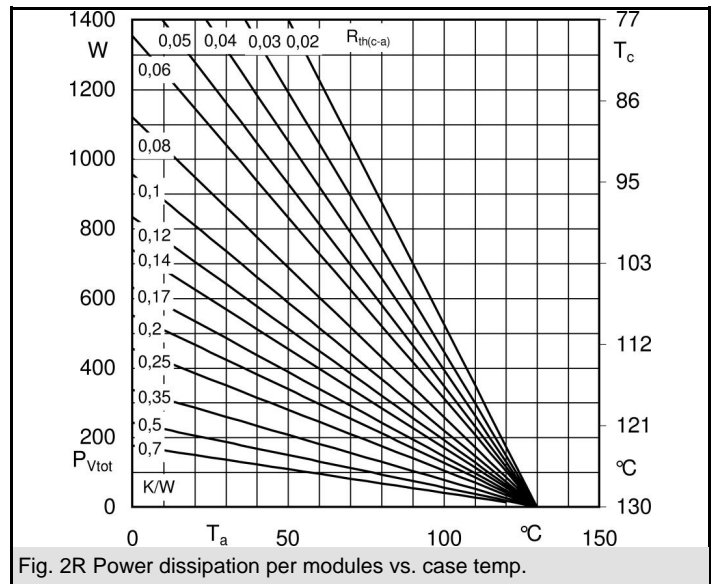
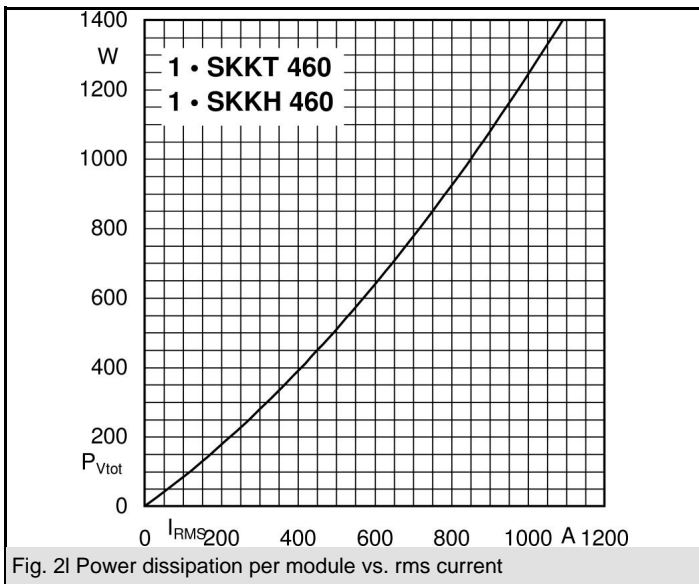
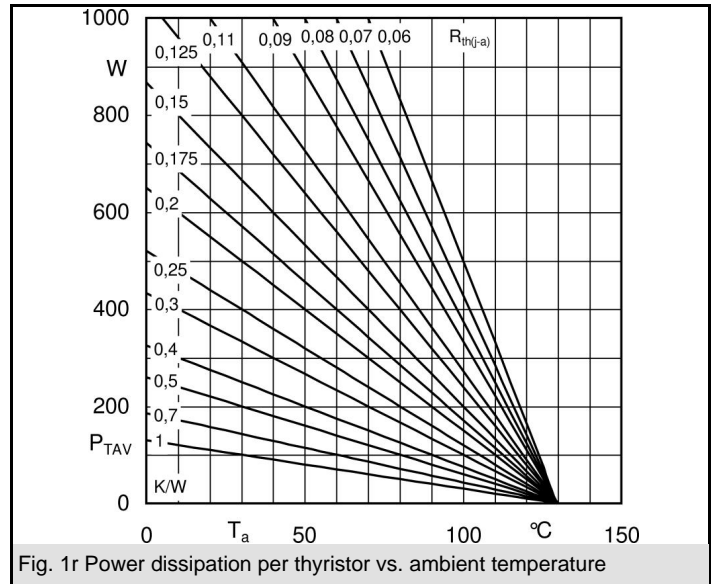
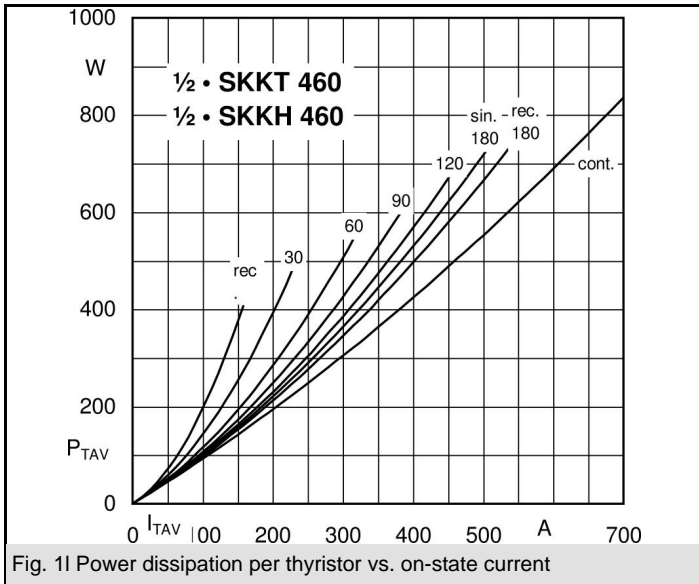

# SKKT 460, SKKH 460

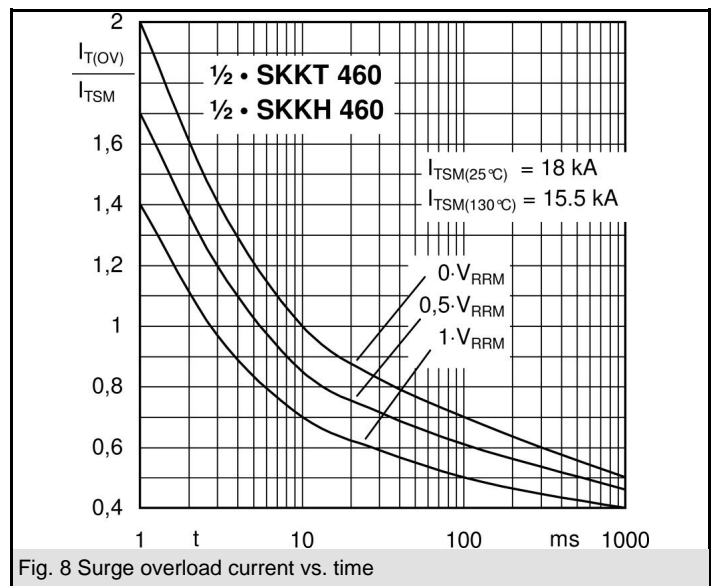
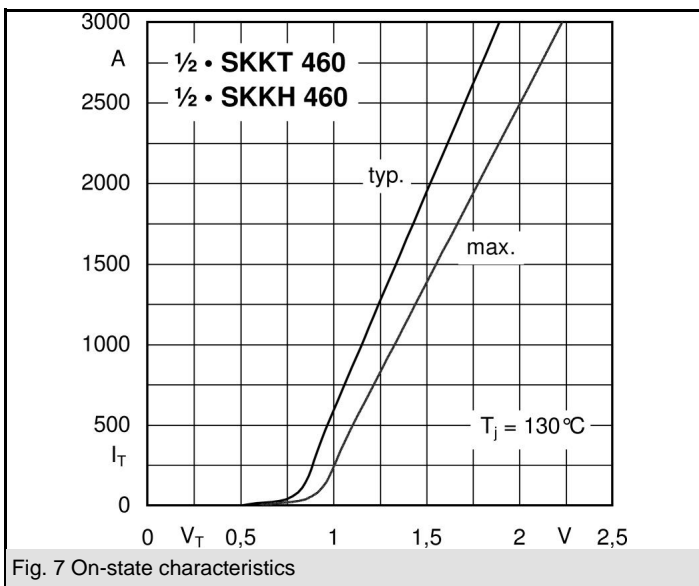
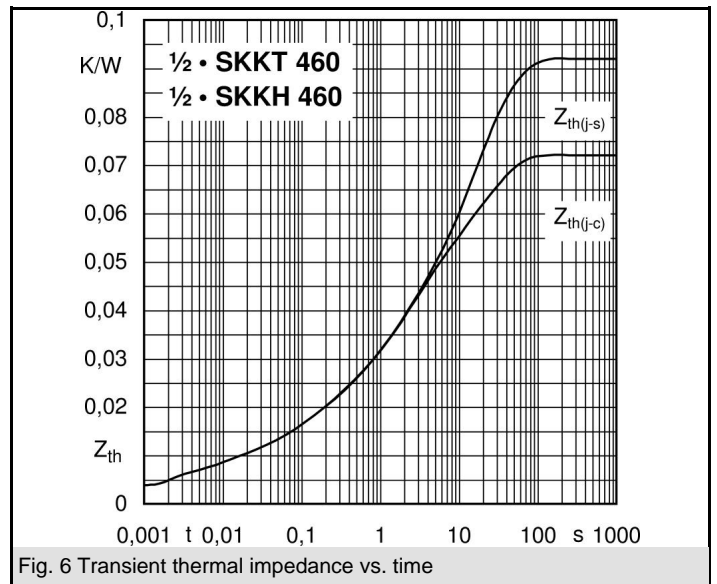
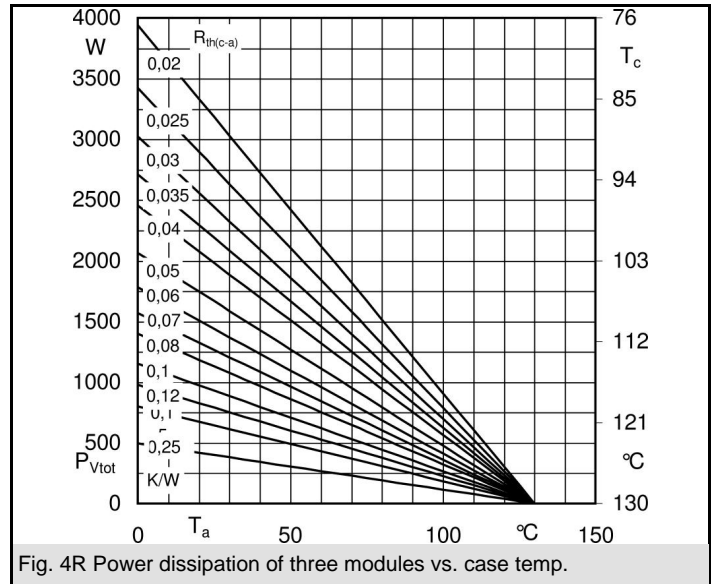
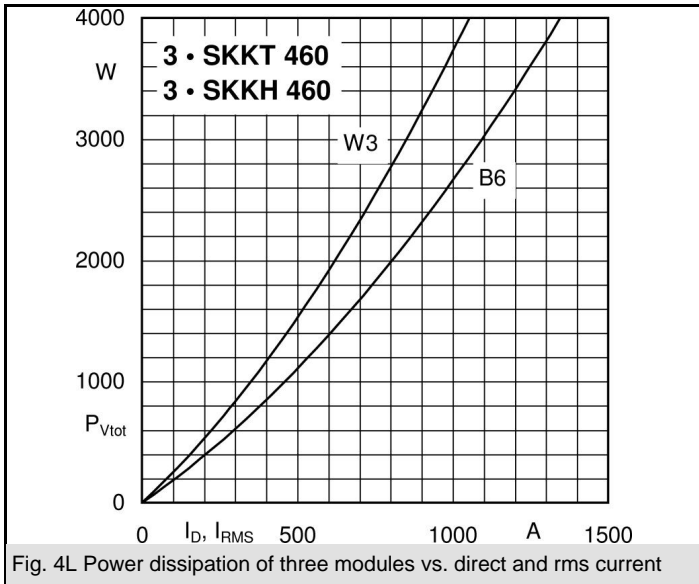

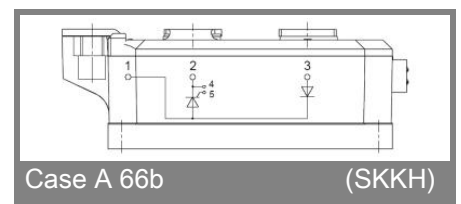
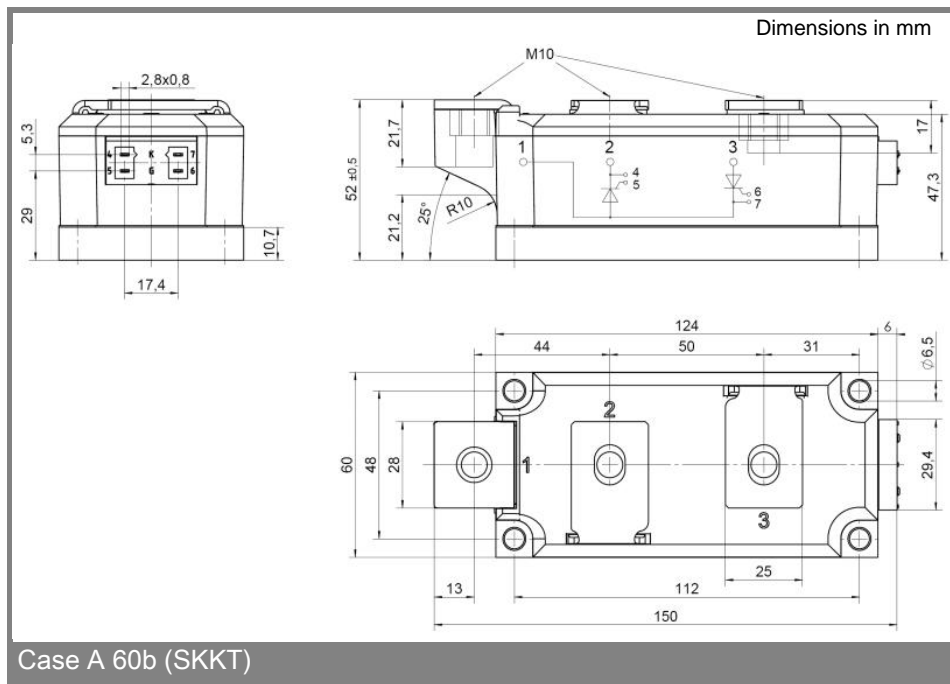
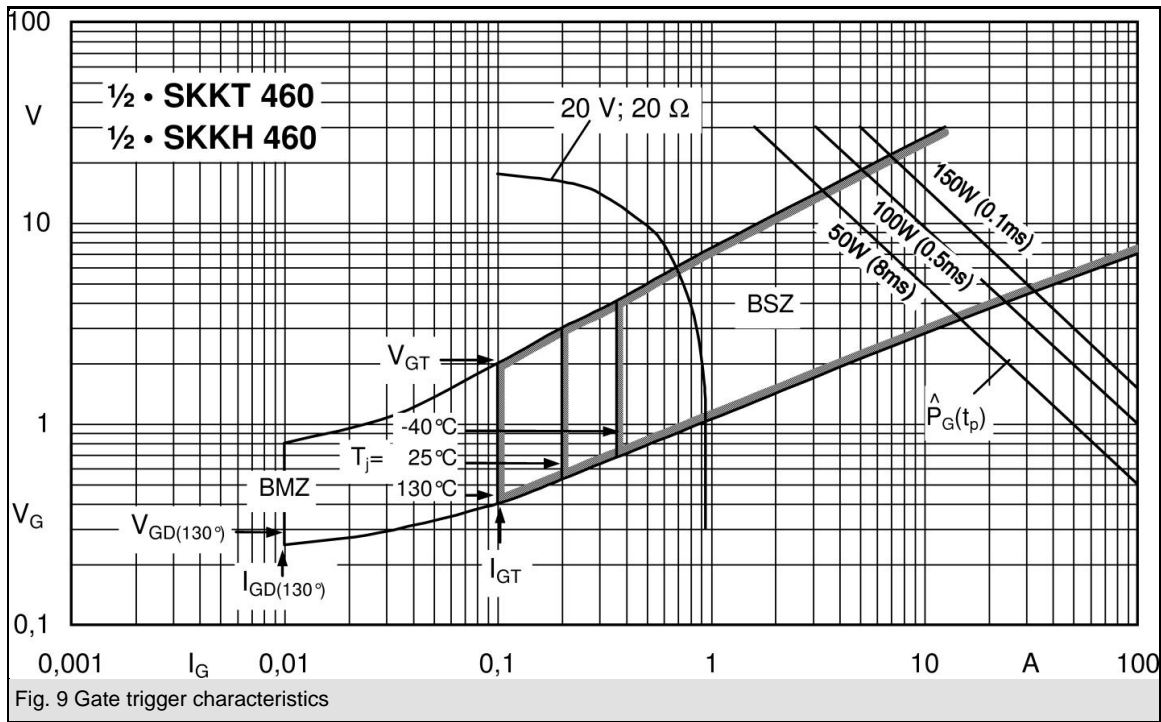

This technical information specifies semiconductor devices but promises no characteristics. No warranty or guarantee expressed or implied is made regarding delivery, performance or suitability.