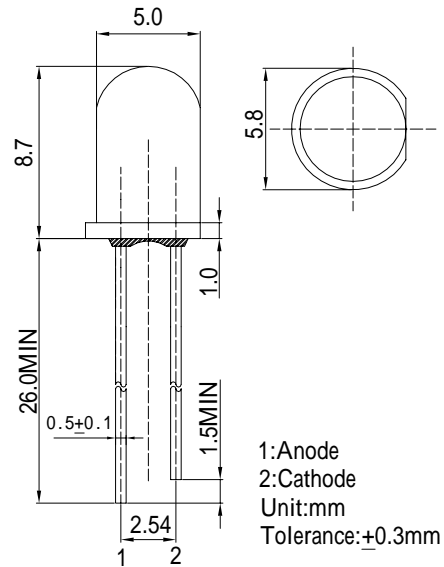

Features

- High Luminous LEDs
- 5mm Round Standard Directivity
- Superior Weather-resistance
- Full Color Flashing Type
- White Diffused Type

Applications

- Toys
- Games
- Audio
- Other Lighting

Outline Dimension

Absolute Maximum Rating

(Ta=25 °C)

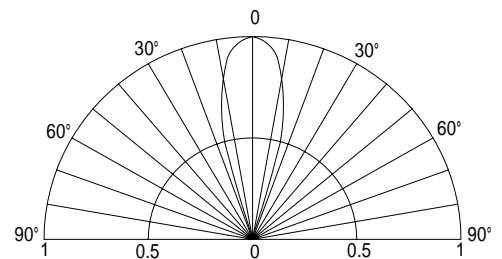
Item	Symbol	Value	Unit
Blinking Cycle	T	12	S
Power Supply	Voltage	5.0	V
Operating Temperature	Topr	-30 ~ +85	
Storage Temperature	Tstg	-40 ~ +100	
Lead Soldering Temperature	Tsol	260 /5sec	

Directivity

Electrical -Optical Characteristics

(Ta=25 °C)

Item	Symbol	Condition	Min.	Typ.	Max.	Unit
DC Forward Voltage	V _{dd}	I _F =20mA	3.8	4.5	5	V
DC Reverse Current	I _R	V _R =5V	-	-	10	μA
Domi. Wavelength	λ _D (Red)	I _F =20mA	619	624	629	nm
	λ _D (Blue)	I _F =20mA	465	470	475	nm
	λ _D (Green)	I _F =20mA	520	525	530	nm
Luminous Intensity	I _v (Red)	I _F =20mA	-	4000	-	mcd
	I _v (Blue)	I _F =20mA	-	2000	-	mcd
	I _v (Green)	I _F =20mA	-	4000	-	mcd
50% Power Angle	2θ _{1/2}	I _F =20mA	-	30	-	deg

*1 Tolerance of dominant Wavelength is ±1nm

*2 Tolerance of luminous intensity is ±15%