

Ultrasoft Recovery Rectifier Diode

PRODUCT APPLICATIONS

- Anti-Parallel Diode
 - Switchmode Power Supply
 - Inverters
- Applications
 - Induction Heating
- Resonant Mode Circuits
 - ZVS and ZCS Topologies
 - Phase Shifted Bridge

PRODUCT FEATURES

- Ultrasoft Recovery Times (t_{rr})
- Popular TO-247 Package or Surface Mount D³PAK Package
- Ultra Low Forward Voltage
- Low Leakage Current

PRODUCT BENEFITS

- Soft Switching - High Q_{rr}
- Low Noise Switching
 - Reduced Ringing
- Higher Reliability Systems
- Minimizes or eliminates snubber

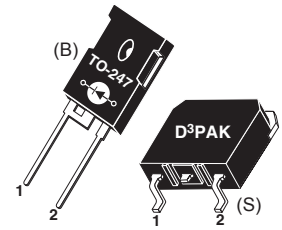

1 - Cathode
 2 - Anode
 Back of Case - Cathode

MAXIMUM RATINGS

All Ratings: $T_C = 25^\circ\text{C}$ unless otherwise specified.

Symbol	Characteristic / Test Conditions	Ratings	Unit
V_R	Maximum D.C. Reverse Voltage	600	Volts
V_{RRM}	Maximum Peak Repetitive Reverse Voltage		
V_{RWM}	Maximum Working Peak Reverse Voltage		
$I_{F(AV)}$	Maximum Average Forward current ($T_C = 112^\circ\text{C}$, Duty Cycle = 0.5)	75	Amps
$I_{F(RMS)}$	RMS Forward Current (Square wave, 50% duty)	121	
I_{FSM}	Non-Repetitive Forward Surge Current ($T_J = 45^\circ\text{C}$, 8.3 ms)	320	
T_J, T_{STG}	Operating and Storage Junction Temperature Range	-55 to 175	$^\circ\text{C}$
T_L	Lead Temperature for 10 Seconds	300	

STATIC ELECTRICAL CHARACTERISTICS

Symbol	Characteristic / Test Conditions	Min	Typ	Max	Unit	
V_F	Forward Voltage		$I_F = 75\text{A}$	1.25	1.6	Volts
			$I_F = 150\text{A}$	2.0		
			$I_F = 75\text{A}, T_J = 125^\circ\text{C}$	1.25		
I_{RM}	Maximum Reverse Leakage Current		$V_R = 600\text{V}$		25	μA
			$V_R = 600\text{V}, T_J = 125^\circ\text{C}$		250	
C_T	Junction Capacitance, $V_R = 200\text{V}$		69		pF	

DYNAMIC CHARACTERISTICS

APT75DL60B_S(G)

Symbol	Characteristic / Test Conditions	Min	Typ	Max	Unit
t_{rr}	Reverse Recovery Time $I_F = 1A, di_F/dt = -100A/\mu s, V_R = 30V, T_J = 25^\circ C$		56		ns
t_{rr}	Reverse Recovery Time		460		
Q_{rr}	Reverse Recovery Charge		2174		
I_{RRM}	Maximum Reverse Recovery Current		11		Amps
t_{rr}	Reverse Recovery Time		597		ns
Q_{rr}	Reverse Recovery Charge		4326		
I_{RRM}	Maximum Reverse Recovery Current		15		
t_{rr}	Reverse Recovery Time		355		ns
Q_{rr}	Reverse Recovery Charge		7215		
I_{RRM}	Maximum Reverse Recovery Current		42		

THERMAL AND MECHANICAL CHARACTERISTICS

Symbol	Characteristic / Test Conditions	Min	Typ	Max	Unit
$R_{\theta JC}$	Junction-to-Case Thermal Resistance			0.40	$^\circ C/W$
W_T	Package Weight		0.22		oz
			5.9		g
Torque	Maximum Mounting Torque			10	lb-in
				1.1	N-m

Microsemi reserves the right to change, without notice, the specifications and information contained herein.

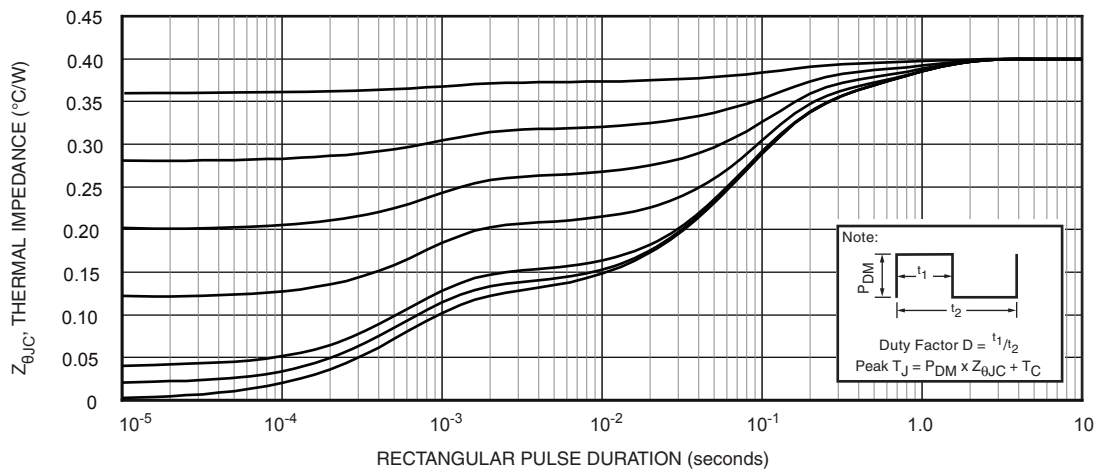

FIGURE 1. MAXIMUM EFFECTIVE TRANSIENT THERMAL IMPEDANCE, JUNCTION-TO-CASE vs. PULSE DURATION

TYPICAL PERFORMANCE CURVES

APT75DL60B_S(G)

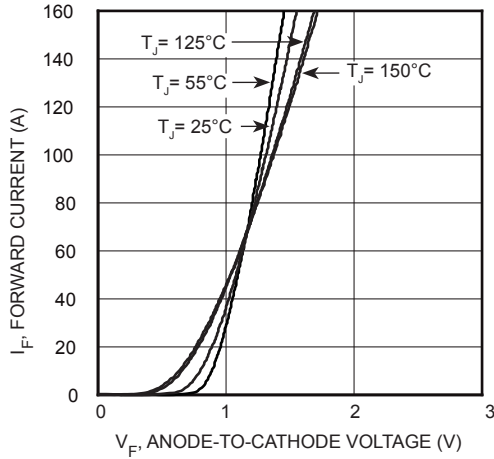

FIGURE 2, Forward Current vs. Forward Voltage

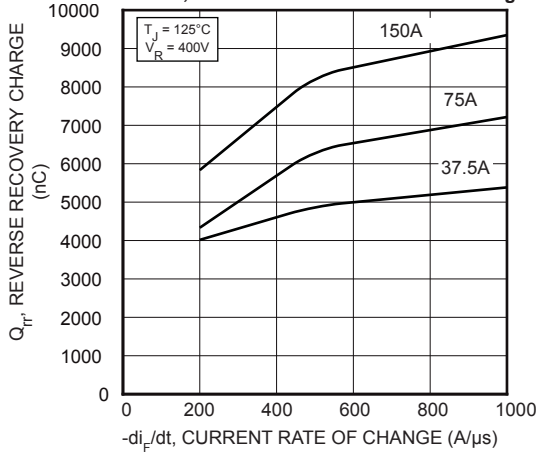

FIGURE 4, Reverse Recovery Charge vs. Current Rate of Change

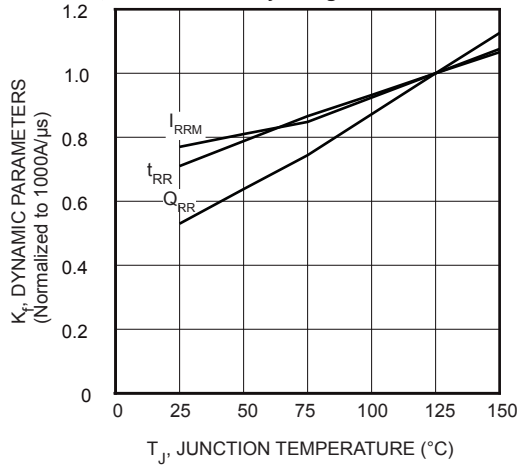

FIGURE 6, Dynamic Parameters vs. Junction Temperature

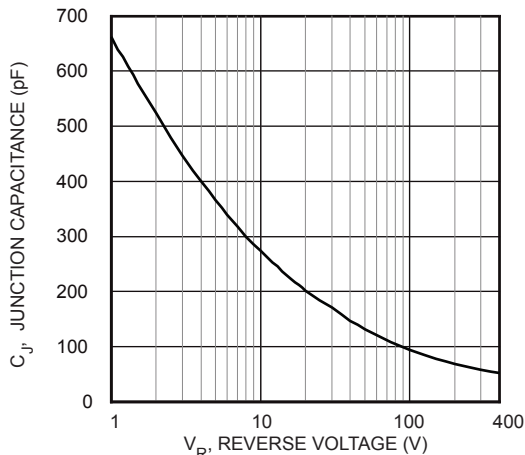

FIGURE 8, Junction Capacitance vs. Reverse Voltage

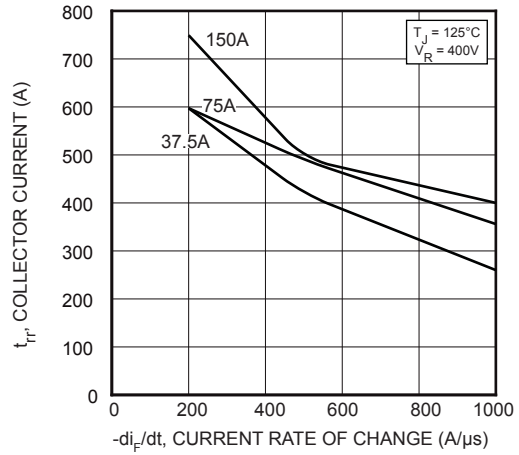

FIGURE 3, Reverse Recovery Time vs. Current Rate of Change

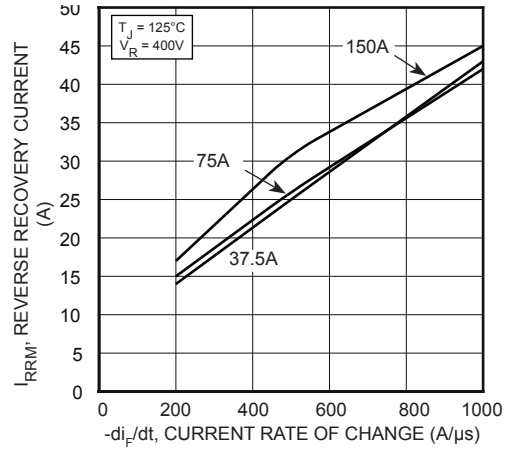

FIGURE 5, Reverse Recovery Current vs. Current Rate of Change

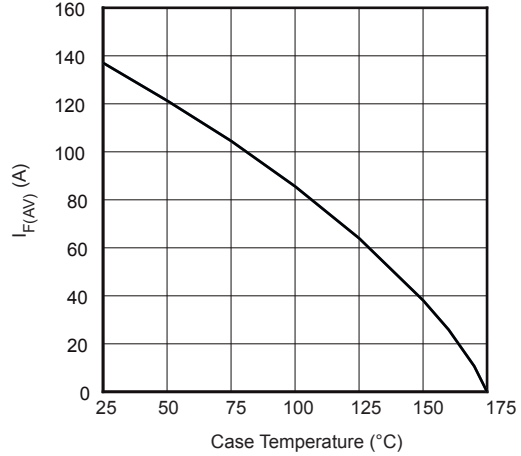

FIGURE 7, Maximum Average Forward Current vs. Case Temperature

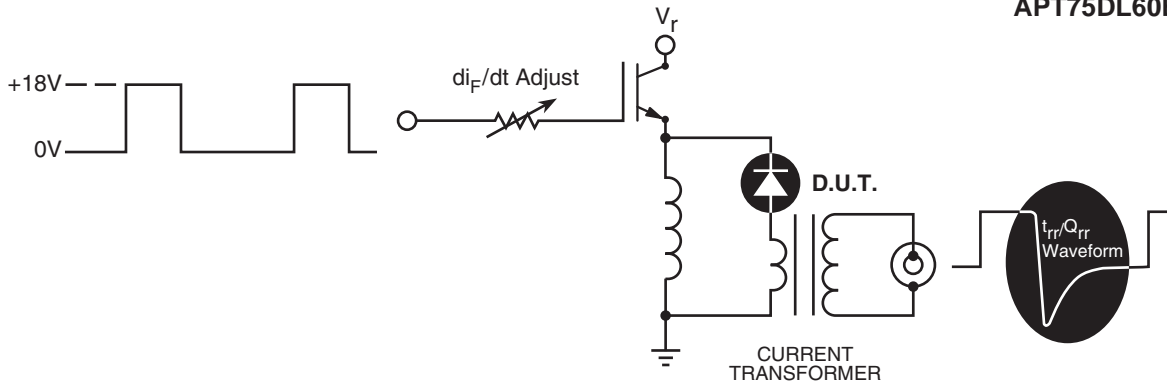

Figure 9. Diode Test Circuit

- 1 I_F - Forward Conduction Current
- 2 di_F/dt - Rate of Diode Current Change Through Zero Crossing.
- 3 I_{RRM} - Maximum Reverse Recovery Current.
- 4 t_{rr} - Reverse Recovery Time, measured from zero crossing where diode current goes from positive to negative, to the point at which the straight line through I_{RRM} and $0.25 \cdot I_{RRM}$ passes through zero.
- 5 Q_{rr} - Area Under the Curve Defined by I_{RRM} and t_{rr} .
- 6 di_M/dt - Maximum Rate of Current Increase During the Trailing Portion of t_{rr} .

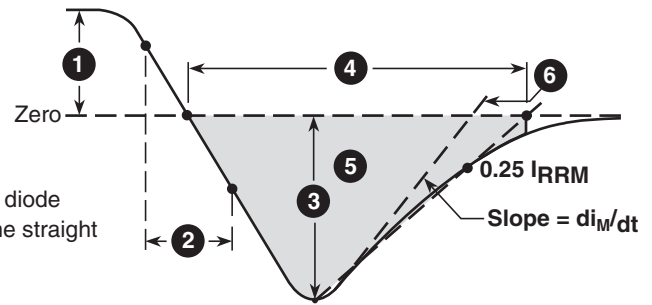
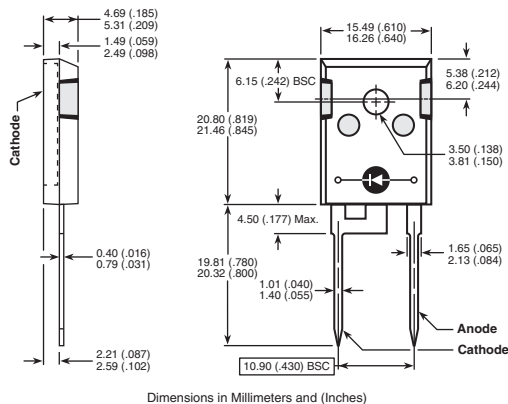

Figure 10, Diode Reverse Recovery Waveform and Definitions

TO-247 Package Outline

e1 SAC: Tin, Silver, Copper



D³PAK Package Outline

e1 100% Sn

