

FEATURES

- Metal-on-silicon junction, majority carrier conduction
- High current capability, Low forward voltage drop
- Extremely low reverse current IR
- Ultra speed switching characteristics
- Small temperature coefficient of forward characteristics
- Satisfactory wave detection efficiency
- For use in recorder, TV ,radio and telephone as detectors
- Super high speed switching cirits, small current rectifier
- High temperature soldering guaranteed:260°C/10 seconds at terminals
- Component in accordance to RoHS 2002/95/EC and WEEE 2002/96/EC

DO-35

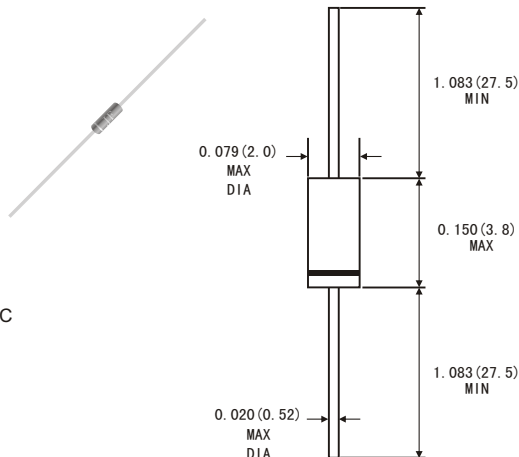

Dimensions in inches and (millimeters)

MECHANICAL DATA

- Case: DO-35 glass case
- Polarity:color band denotes cathode end
- Weight: Approx. 0.13 gram

ABSOLUTE RATINGS(LIMITING VALUES)

Symbols	Parameters		Value		Units
			1N60	1N60P	
VRRM	Repetitive Peak Reverse Voltage		40	40	Volts
IF	Forward Continuous Current	T _A =25°C	30	50	mA
IFSM	Peak Forward Surge Current(t=1s)		150	400	mA
TSTG	Storage and junction Temperature Range		-55 to+75		°C
TJ	Maximum Lead Temperature for Soldering during 10s at 4mm from Case		75		°C

ELECTRICAL CHARACTERISTICS

Symbols	Parameters	Test Conditions	Value			Units
			Min.	Typ.	Max.	
VF	Forward Voltage	I _F =1mA	1N60	0.35	0.5	Volts
			1N60P	0.26	0.5	
		I _F =30mA	1N60	0.70	1.0	
			1N60P	0.70	1.0	
IR	Reverse Current	V _R =15V	1N60	1.0	5.0	mA
			1N60P	5.0	10.0	
C _J	Junction Capacitance	V _R =1V f=1MHz	1N60	4.0		pF
		V _R =10V f=1MHz	1N60P	10.0		
h	Detection Efficiency(See diagram 4)	V _I =3V f=30MHz C _L =10pF R _L =3.8kW		60		%
t _{rr}	Reverse Recovery time	I _F =I _R =1mA I _{rr} =1mA R _C =100W			1	ns
R _{θJA}	Junction Ambient Thermal Resistance			400		°C/W

RATINGS AND CHARACTERISTIC CURVES 1N60

FIG.1-FORWARD CURRENT VERSUS FORWARD VOLTAGE (TYPICAL VALUES)

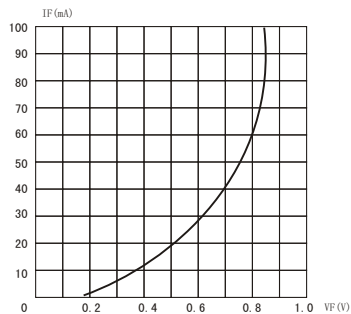

FIG.2-REVERSE CURRENT VERSUS CONTINUOUS REVERSE VOLTAGE

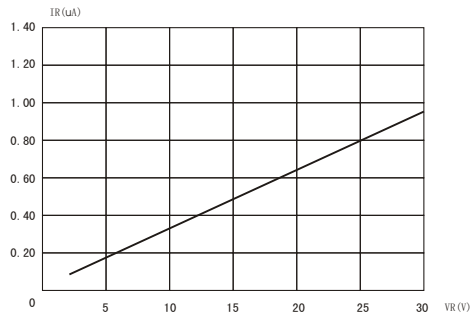

FIG.3-JUNCTION CAPACITANCE VERSUS CONTINUOUS REVERSE APPLIED VOLTAGE

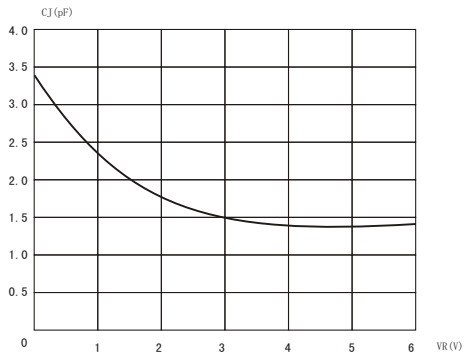
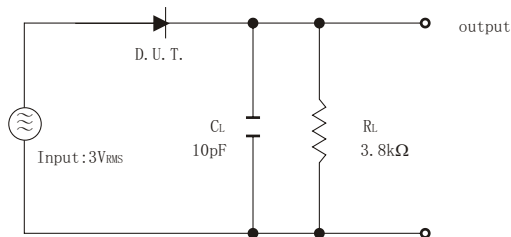

FIG.4-DETECTION EFFICIENCY MEASUREMENT CIRCUIT



RATINGS AND CHARACTERISTICS CURVES 1N60P

FIG.1-FORWARD CURRENT VERSUS FORWARD VOLTAGE (TYPICAL VALUES)

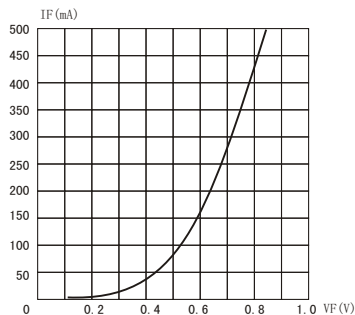

FIG.2-REVERSE CURRENT VERSUS CONTINUOUS REVERSE VOLTAGE

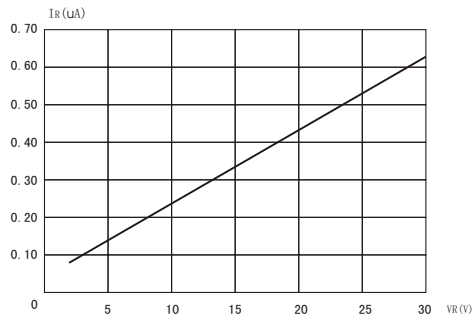

FIG.3-JUNCTION CAPACITANCE VERSUS CONTINUOUS REVERSE APPLIED VOLTAGE

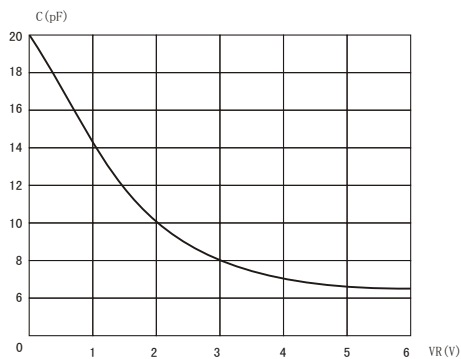

FIG.4-DETECTION EFFICIENCY MEASUREMENT CIRCUIT

