

NUS6160MN

Low Profile Overvoltage Protection IC with Integrated MOSFET

This device represents a new level of safety and integration by combining an overvoltage protection circuit (OVP) with a dual 20 V P-channel power MOSFET. The OVP is specifically designed to protect sensitive electronic circuitry from overvoltage transients and power supply faults. During such events, the IC quickly disconnects the input supply from the load, thus protecting it. The integration of the additional transistor and power MOSFET reduces layout space and promotes better charging performance.

The IC is optimized for applications that use an external AC-DC adapter or a car accessory charger to power a portable product or recharge its internal batteries.

Features

- Overvoltage Turn-Off Time of Less Than 1.5 μ s
- Undervoltage Lockout Protection; 3.0 V, Nominal
- High Accuracy Undervoltage Threshold of 5.0%
- -20 V Integrated P-Channel Power MOSFET
- Low $R_{DS(on)}$ = 64 m Ω @ -4.5 V
- Compact 3.0 x 4.0 mm QFN Package
- Maximum Solder Reflow Temperature @ 260°C
- This is a Pb-Free Device

Benefits

- Provide Battery Protection
- Integrated Solution Offers Cost and Space Savings
- Integrated Solution Improves System Reliability
- Optimized for Commercial PMUs from Top Suppliers

Applications

- Portable Computers and PDAs
- Cell Phones and Handheld Products
- Digital Cameras



ON Semiconductor®

<http://onsemi.com>

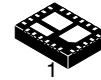

QFN22
CASE 485AT

MARKING DIAGRAM

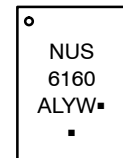

NUS6160 = Device Code

A = Assembly Location

L = Wafer Lot

Y = Year

W = Work Week

▪ = Pb-Free Package

(Note: Microdot may be in either location)

ORDERING INFORMATION

Device	Package	Shipping†
NUS6160MNTWG	QFN22 (Pb-Free)	3000 / Tape & Reel

†For information on tape and reel specifications, including part orientation and tape sizes, please refer to our Tape and Reel Packaging Specification Brochure, BRD8011/D.

NUS6160MN

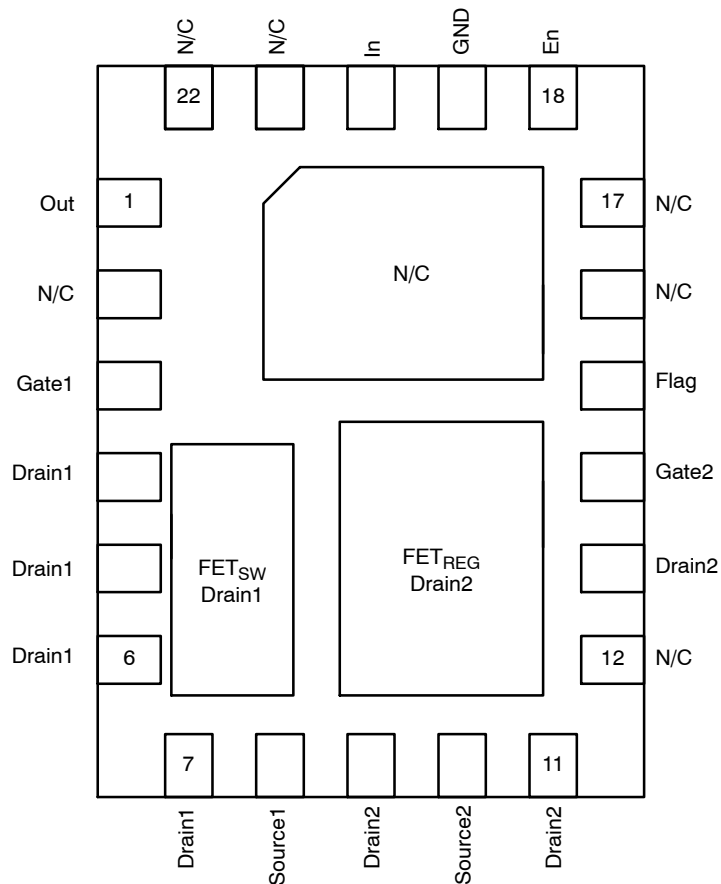

(Top View)

Figure 1. Pinout

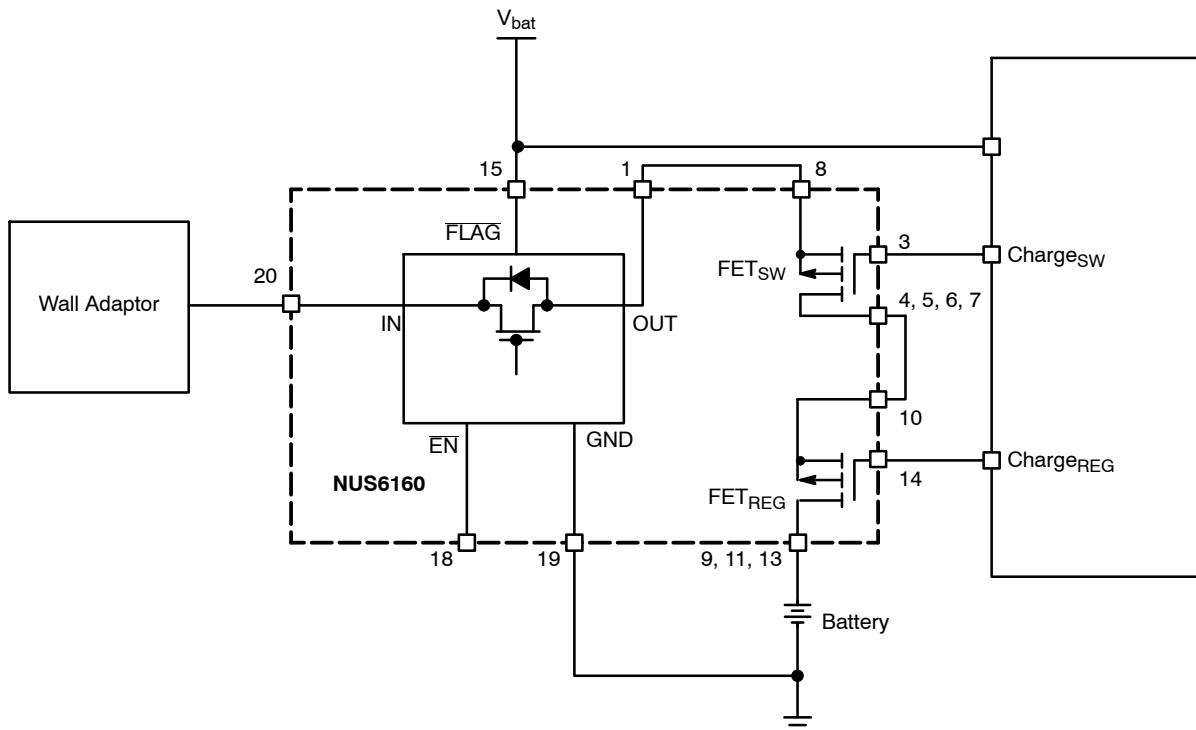

Figure 2. Typical Charging Solution

NUS6160MN

MAXIMUM RATINGS (T_J = 25°C, unless otherwise stated)

Rating	Symbol	Min	Max	Unit
V _{IN} to Ground	V _{IN}	-0.3	21	V
OUT, $\overline{\text{EN}}$, $\overline{\text{FLAG}}$ Pins Voltage to Ground	V _{OUT} , $\overline{\text{V}}_{\text{EN}}$, $\overline{\text{V}}_{\text{FLAG}}$	-0.3	7.0	V
Maximum Current from V _{IN} to V _{OUT} (PMOS)	I _{max}		600	mA
Drain-to-Source Voltage	V _{DSS}		-20	V
Gate-to-Source Voltage	V _{GS}	-8.0	8.0	V
Continuous Drain Current, Steady State	I _D		-2.0	A
Pulsed Drain Current, t _p = 10 ms	I _{DM}		-4.0	A
Source Current	I _S		-1.1	A
Operating Ambient Temperature	T _A	-40	85	°C
Storage Temperature	T _{STG}	-55	150	°C
Operating Junction Temperature	T _J		150	°C
Thermal Resistance (Note 1)	θ _{JA}			°C/W
1 in ² (645 mm ²) (All devices fully enhanced)				
OVP FET			68	
FET _{SW}			42	
FET _{REG}			46	
1 in ² (645 mm ²) (OVP and FET _{SW} fully enhanced, 1 V drop across FET _{REG})				
OVP FET			43	
FET _{SW}			39	
FET _{REG}			80	
0.25 in ² (161 mm ²) (All devices fully enhanced)				
OVP FET			79	
FET _{SW}			53	
FET _{REG}			56	
0.25 in ² (161 mm ²) (OVP and FET _{SW} fully enhanced, 1 V drop across FET _{REG})				
OVP FET			53	
FET _{SW}			49	
FET _{REG}			92	
ESD Performance (Human Body Model) Pins 1, 15, 18, 19, 20	-		2.5	kV
Lead Temperature for Soldering Purposes (1/8" from case for 10 s)	T _L		260	°C

Stresses exceeding Maximum Ratings may damage the device. Maximum Ratings are stress ratings only. Functional operation above the Recommended Operating Conditions is not implied. Extended exposure to stresses above the Recommended Operating Conditions may affect device reliability.

1. 1 oz. copper, double sided board. Thermal impedance requires total for ΔT calculations. See example in thermal description.

NUS6160MN

PIN DESCRIPTION

Pin	Name	Description
1	Out	This pin is the output of the internal OVP chip. It must be connected to the source of the upper FET (Pin 8).
3	Gate FET _{SW}	This pin is the gate of the upper FET which is normally used for a switch in series with the battery. It is controlled by the PMU.
4, 5, 6, 7	Drain FET _{SW}	These pins are the drain of the upper FET. For the lowest on resistance connect all pins together. This set of pins must be connected to the source of the lower (regulator) FET, Pin 10.
8	Source FET _{SW}	This pin is the source of the upper FET and must be connected to the output pin of the internal OVP chip (Pin 1).
9, 11, 13	Drain FET _{REG}	These pins are the drain of the lower FET which is normally used for the regulation function. It connects to the positive terminal of the battery.
10	Source FET _{REG}	This pin is the source of the lower FET and must be connected to the drain pins of the upper FET.
12	N/C	This pin has no internal connections and is isolated from all internal circuitry within the chip.
14	Gate FET _{REG}	This pin is the gate of the lower FET which is normally used for the regulation function in series with the battery. It is controlled by the PMU.
15	FLAG	The fault flag is an open drain output and therefore requires a pullup resistor. The FLAG pin will be driven low when the input voltage exceeds the OVLO trip level.
2, 16, 17, 21, 22	N/C	These pins are connected to the ground of the analog chip. This is a medium impedance connection and should not be used for the ground signal. These pins should either be left floating or connected to ground, but not any other potential. If these pins are connected to ground, the ground pin (19) must still be used.
18	EN	The ENABLE pin must be held low for normal operation. When this pin is tied high the unit will be shut down. The state of the enable pin has no impact on the FAULT pin.
19	Gnd	This is the ground reference pin for the internal OVP chip.
20	In	This pin is the input to the internal OVP chip and connects to the wall, or car adaptor.

NUS6160MN

OVP ELECTRICAL CHARACTERISTICS

(Min/Max limits values ($-40^{\circ}\text{C} < T_A < +85^{\circ}\text{C}$) and $V_{in} = +5.0\text{ V}$. Typical values are $T_A = +25^{\circ}\text{C}$, unless otherwise noted.)

Characteristic	Symbol	Conditions	Min	Typ	Max	Unit
Input Voltage Range	V_{in}		1.2		20	V
Undervoltage Lockout Threshold	UVLO	V_{in} falls down UVLO threshold	2.85	3.0	3.15	V
Undervoltage Lockout Hysteresis	UVLO _{hyst}		30	50	70	mV
Overvoltage Lockout Threshold	OVLO	V_{in} rises up OVLO threshold	6.9	7.07	7.4	V
Overvoltage Lockout Hysteresis	OVLO _{hyst}		50	100	125	mV
V_{in} versus V_{out} Dropout	V_{drop}	$V_{in} = 5\text{ V}$, I charge = 500 mA		105	200	mV
Supply Quiescent Current	I _{dd}	No Load, $V_{in} = 5.25\text{ V}$		24	35	μA
OVLO Supply Current	I _{dd} _{ovlo}	$V_{in} = 8\text{ V}$		50	85	μA
Output Off State Current	I _{std}	$V_{in} = 5.25\text{ V}$, EN = 1.2 V		26	37	μA
$\overline{\text{FLAG}}$ Output Low Voltage	V _{ol} _{flag}	$V_{in} > \text{OVLO}$, Sink 1 mA on $\overline{\text{FLAG}}$ pin			400	mV
$\overline{\text{FLAG}}$ Leakage Current	FLAG _{leak}	$\overline{\text{FLAG}}$ level = 5 V		5.0		nA
$\overline{\text{EN}}$ Voltage High	V_{ih}	V_{in} from 3.3 V to 5.25 V	1.2			V
$\overline{\text{EN}}$ Voltage Low	V_{ol}	V_{in} from 3.3 V to 5.25 V			0.4	V
$\overline{\text{EN}}$ Leakage Current	EN _{leak}	EN = 5.5 V or GND		170		nA

TIMINGS

Start Up Delay	t _{on}	From $V_{in} > \text{UVLO}$ to $V_{out} = 0.8 \times V_{in}$, See Fig 3 & 9		4.0	15	ms
$\overline{\text{FLAG}}$ going up Delay	t _{start}	From $V_{in} > \text{UVLO}$ to $\overline{\text{FLAG}} = 1.2\text{ V}$, See Fig 3 & 10		3.0		μs
Output Turn Off Time	t _{off}	From $V_{in} > \text{OVLO}$ to $V_{out} \leq 0.3\text{ V}$, See Fig 4 & 11 V_{in} increasing from normal operation to $>\text{OVLO}$ at 1V/ μs . No output capacitor.		0.8	1.5	μs
Alert Delay	t _{stop}	From $V_{in} > \text{OVLO}$ to $\overline{\text{FLAG}} \leq 0.4\text{ V}$, See Fig 4 & 12 V_{in} increasing from normal operation to $>\text{OVLO}$ at 1V/ μs		1.0	2.0	μs
Disable Time	t _{dis}	From $\overline{\text{EN}} 0.4$ to 1.2V to $V_{out} \leq 0.3\text{V}$, See Fig 5 & 13 $V_{in} = 4.75\text{ V}$. No output capacitor.		2.0		μs
Thermal Shutdown Temperature	T _{sd}			150		$^{\circ}\text{C}$
Thermal Shutdown Hysteresis	T _{sdhyst}			30		$^{\circ}\text{C}$

NOTE: Thermal Shutdown parameter has been fully characterized and guaranteed by design.

NUS6160MN

MOSFET ELECTRICAL CHARACTERISTICS ($T_J = 25^\circ\text{C}$ unless otherwise noted, all parameters apply to both FET_{SW} and FET_{REG})

Characteristic	Symbol	Test Condition	Min	Typ	Max	Unit
----------------	--------	----------------	-----	-----	-----	------

OFF CHARACTERISTICS

Drain-to-Source Breakdown Voltage	$V_{(BR)DSS}$	$V_{GS} = 0\text{ V}, I_D = -250\ \mu\text{A}$	-20			V
Drain-to-Source Breakdown Voltage Temperature Coefficient	$V_{(BR)DSS}/T_J$			-15		mV/ $^\circ\text{C}$
Zero Gate Voltage Drain Current	I_{DSS}	$V_{GS} = 0\text{ V}$ $V_{DS} = -16\text{ V}$	$T_J = 25^\circ\text{C}$		-1.0	μA
			$T_J = 85^\circ\text{C}$		-5.0	
Gate-to-Source Leakage Current	I_{GSS}	$V_{DS} = 0\text{ V}, V_{GS} = \pm 8.0\text{ V}$			± 100	nA

ON CHARACTERISTICS (Note 2)

Gate Threshold Voltage	$V_{GS(TH)}$	$V_{GS} = V_{DS}, I_D = -250\ \mu\text{A}$	-0.45		-1.5	V
Gate Threshold Temperature Coefficient	$V_{GS(TH)}/T_J$			2.7		mV/ $^\circ\text{C}$
Drain-to-Source On Resistance	$R_{DS(ON)}$	$V_{GS} = -4.5\text{ V}, I_D = -1.0\text{ A}$		64	80	m Ω
		$V_{GS} = -4.5\text{ V}, I_D = -0.6\text{ A}$		62	80	
Forward Transconductance	g_{FS}	$V_{DS} = -10\text{ V}, I_D = -2.9\text{ A}$		7.0		S

CHARGES, CAPACITANCES, AND GATE RESISTANCE

Input Capacitance	C_{ISS}	$V_{GS} = 0\text{ V}, f = 1.0\text{ MHz},$ $V_{DS} = -16\text{ V}$		750		pF
Output Capacitance	C_{OSS}			100		
Reverse Transfer Capacitance	C_{RSS}			45		
Total Gate Charge	$Q_{G(TOT)}$	$V_{GS} = -4.5\text{ V}, V_{DS} = -16\text{ V},$ $I_D = -2.6\text{ A}$		7.6	8.6	nC
Gate-to-Source Charge	Q_{GS}			1.3		
Gate-to-Drain Charge	Q_{GD}			2.6		

SWITCHING CHARACTERISTICS (Note 3)

Turn-On Delay Time	$t_{d(ON)}$	$V_{GS} = -4.5\text{ V}, V_{DD} = -16\text{ V},$ $I_D = -2.6\text{ A}, R_G = 2.0\ \Omega$		5.5		ns
Rise Time	t_r			12		
Turn-Off Delay Time	$t_{d(OFF)}$			32		
Fall Time	t_f			23		

DRAIN-SOURCE DIODE CHARACTERISTICS

Forward Diode Voltage	V_{SD}	$V_{GS} = 0\text{ V}, I_S = -1.1\text{ A}$		-0.8	-1.2	V
Reverse Recovery Time	t_{RR}	$V_{GS} = 0\text{ V}, dI_S/dt = 100\text{ A}/\mu\text{s},$ $I_S = 1.0\text{ A}$		20		ns
Charge Time	t_a			15		
Discharge Time	t_b			5		
Reverse Recovery Charge	Q_{RR}			0.01		

- Pulse test: pulse width $\leq 300\ \mu\text{s}$, duty cycle $\leq 2\%$
- Switching characteristics are independent of operating junction temperatures

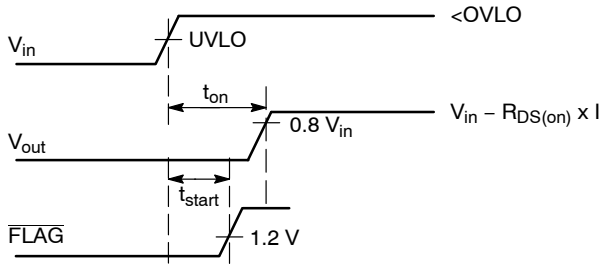

Figure 3. Start Up Sequence

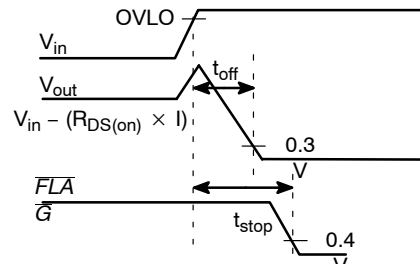

Figure 4. Shutdown on Over Voltage Detection

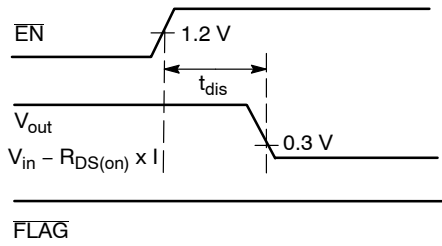

Figure 5. Disable on EN = 1

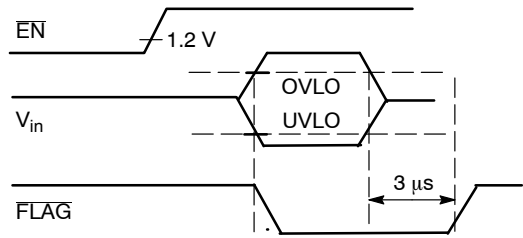

Figure 6. FLAG Response with EN = 1

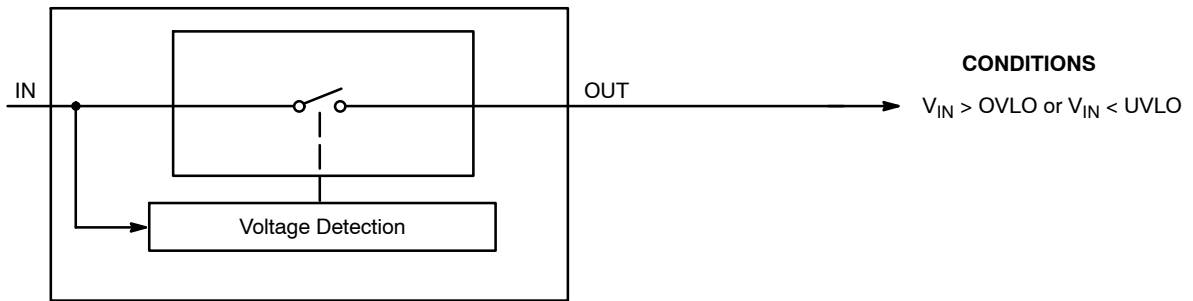

Figure 7.

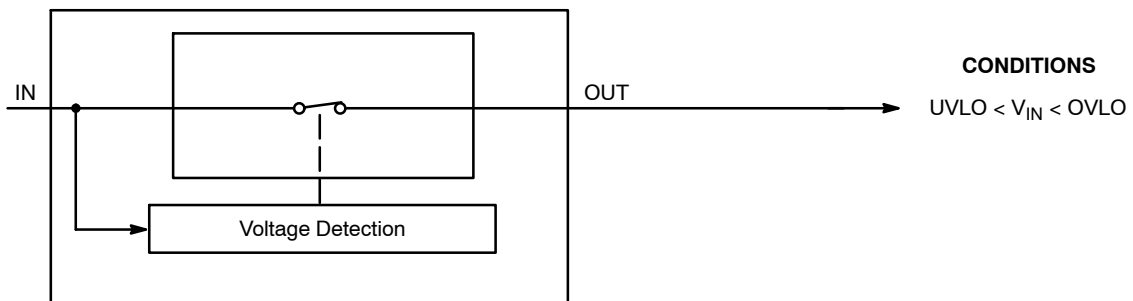

Figure 8.

TYPICAL OPERATING CHARACTERISTICS

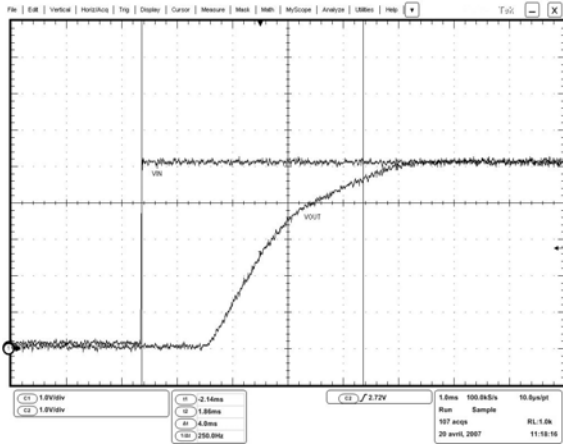

Figure 9. Startup
 $V_{in} = \text{Ch1}, V_{out} = \text{Ch3}$

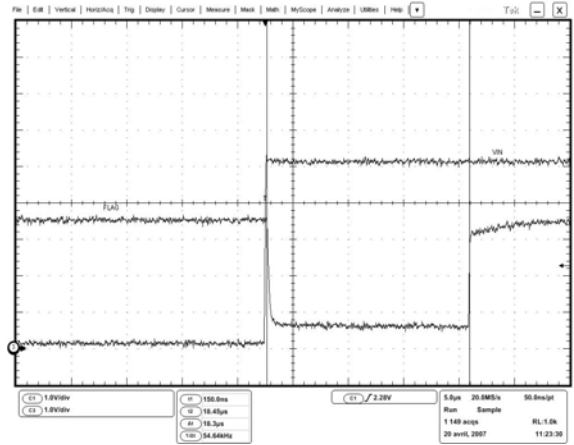

Figure 10. FLAG Going Up Delay
 $V_{out} = \text{Ch3}, \text{FLAG} = \text{Ch2}$

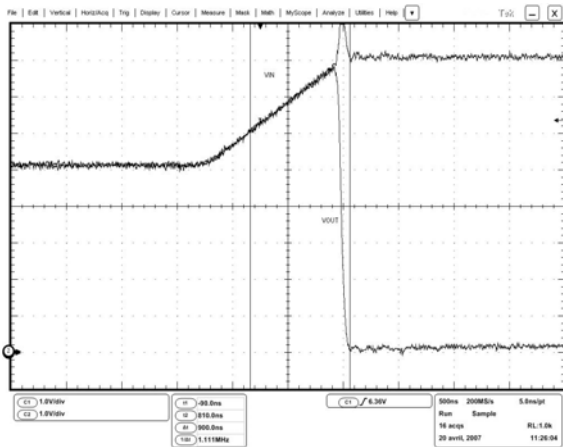

Figure 11. Output Turn Off Time
 $V_{in} = \text{Ch1}, V_{out} = \text{Ch2}$

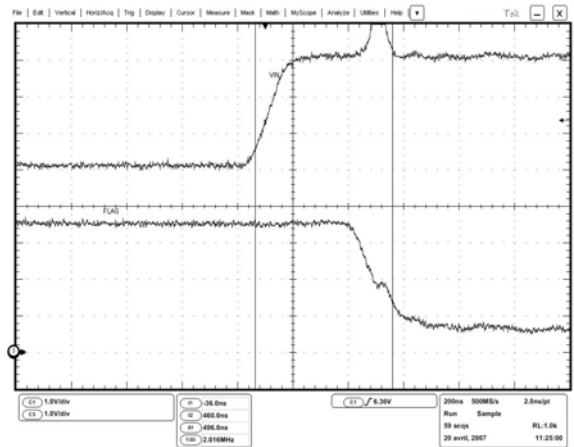

Figure 12. Alert Delay
 $V_{out} = \text{Ch1}, \text{FLAG} = \text{Ch3}$

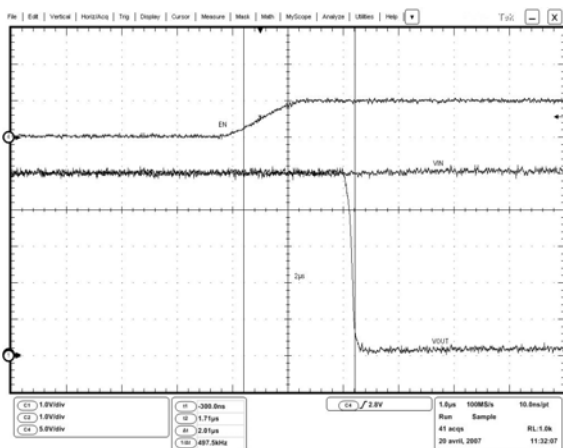

Figure 13. Disable Time
 $\text{EN} = \text{Ch1}, V_{out} = \text{Ch2}, \text{FLAG} = \text{Ch3}$

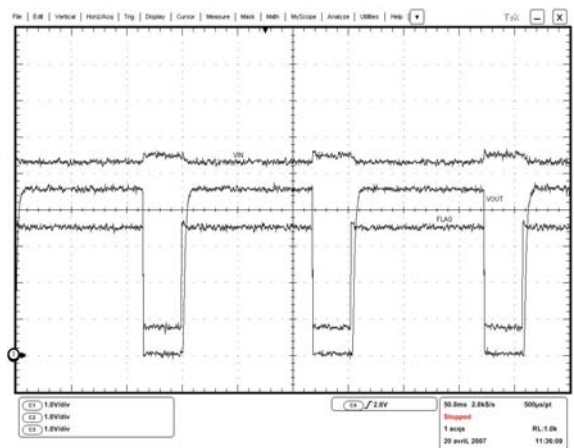

Figure 14. Thermal Shutdown
 $V_{in} = \text{Ch1}, V_{out} = \text{Ch2}, \text{FLAG} = \text{Ch3}$

NUS6160MN

TYPICAL OPERATING CHARACTERISTICS

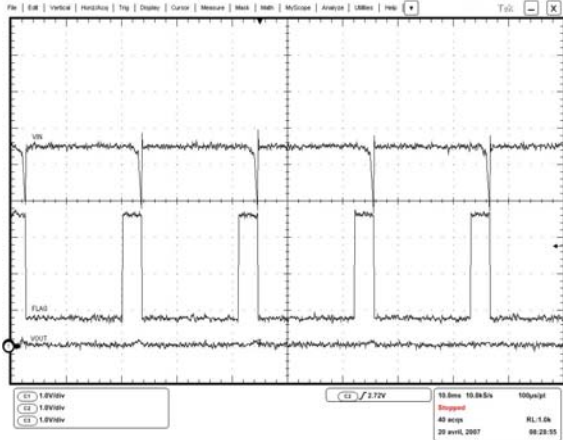

Figure 15. Direct Output Short Circuit

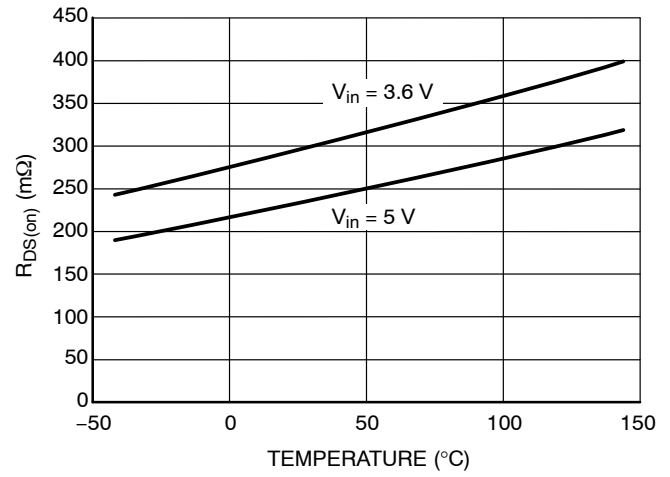

Figure 16. $R_{DS(on)}$ vs. Temperature
(Load = 500 mA)

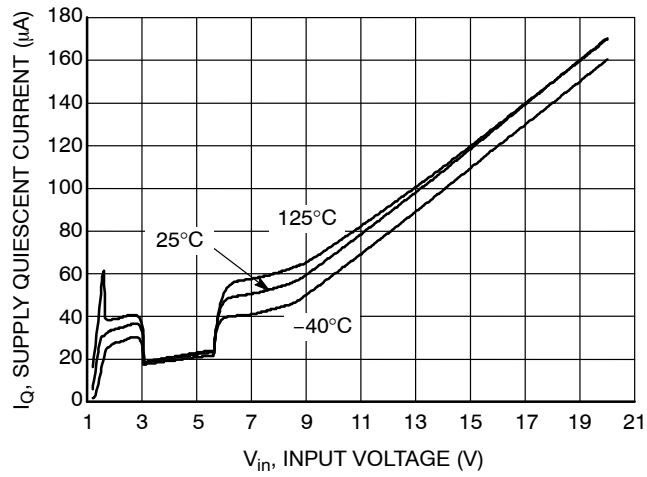

Figure 17. Supply Quiescent Current vs. V_{in}

NUS6160MN

TYPICAL PERFORMANCE CURVES ($T_J = 25^\circ\text{C}$ unless otherwise noted)

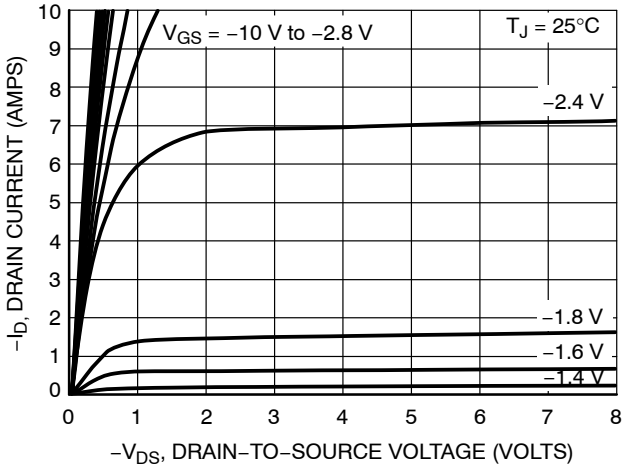

Figure 18. On-Region Characteristics

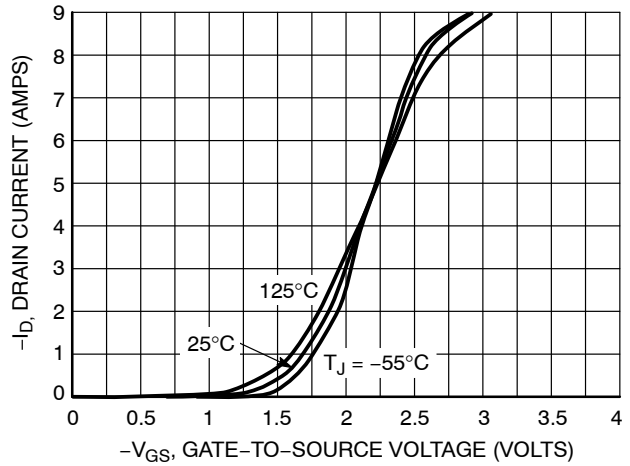

Figure 19. Transfer Characteristics

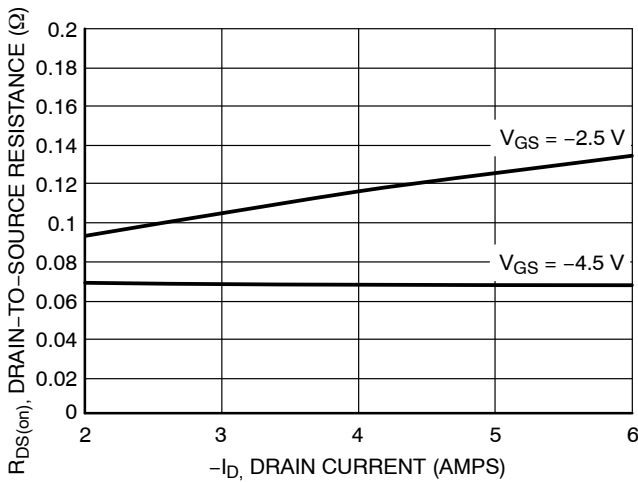

Figure 20. On-Resistance vs. Drain Current and Gate Voltage

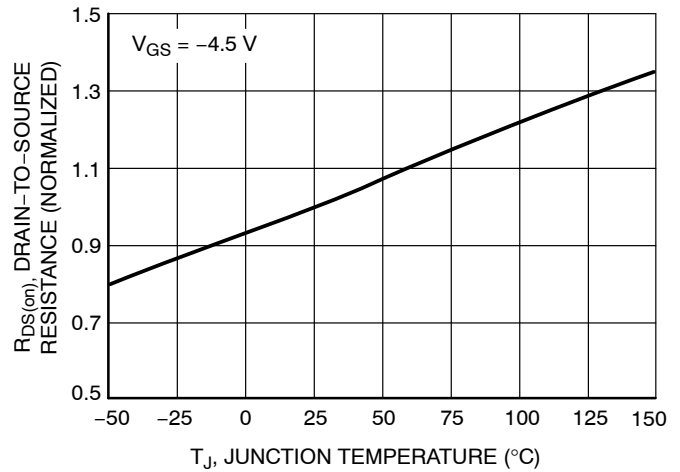

Figure 21. On-Resistance Variation with Temperature

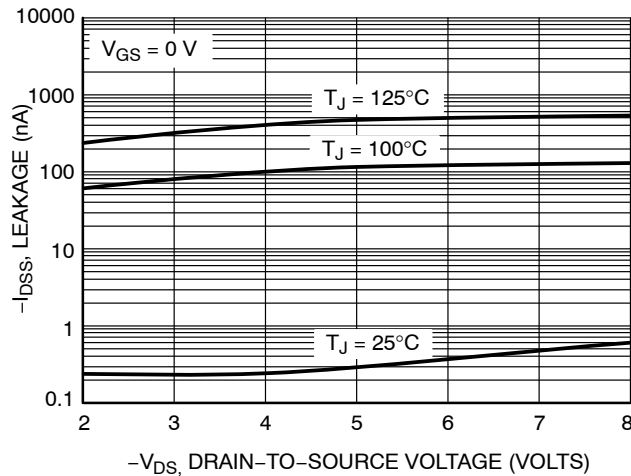

Figure 22. Drain-to-Source Leakage Current vs. Voltage

TYPICAL PERFORMANCE CURVES ($T_J = 25^\circ\text{C}$ unless otherwise noted)

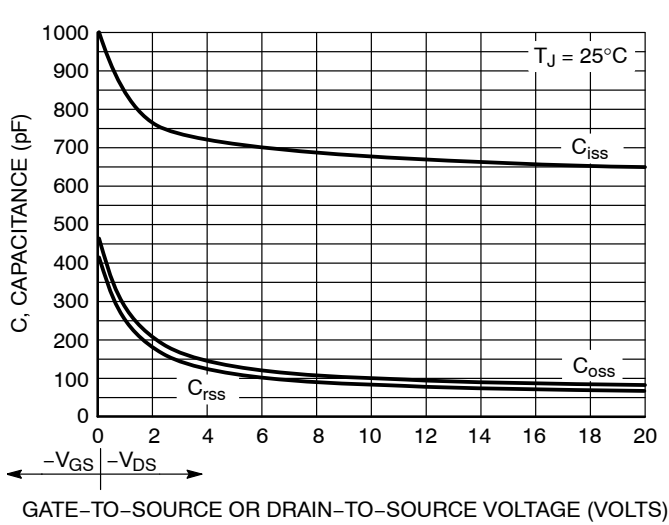

Figure 23. Capacitance Variation

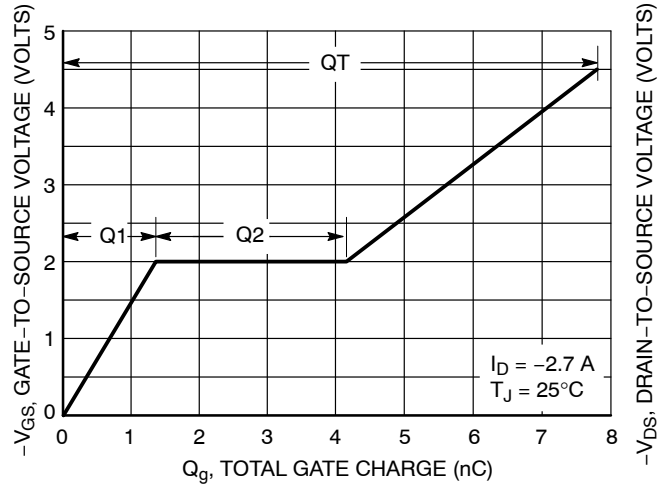

Figure 24. Gate-to-Source and Drain-to-Source Voltage vs. Total Gate Charge

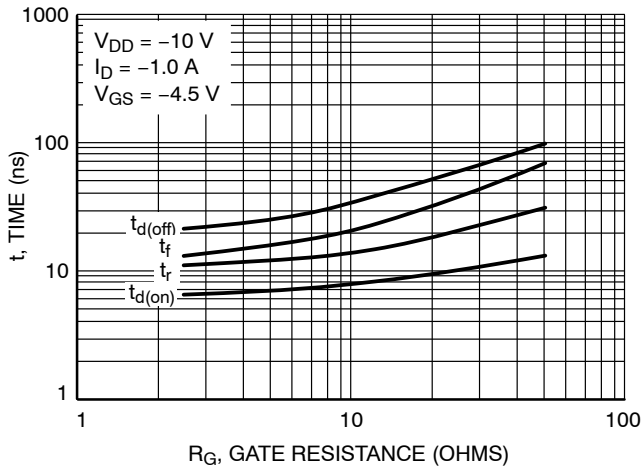

Figure 25. Resistive Switching Time Variation vs. Gate Resistance

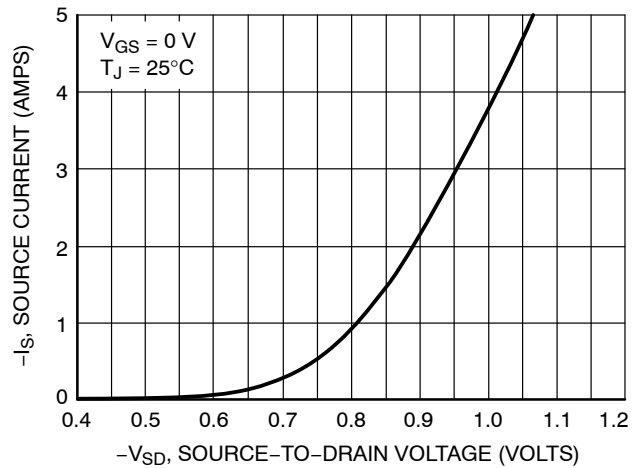

Figure 26. Diode Forward Voltage vs. Current

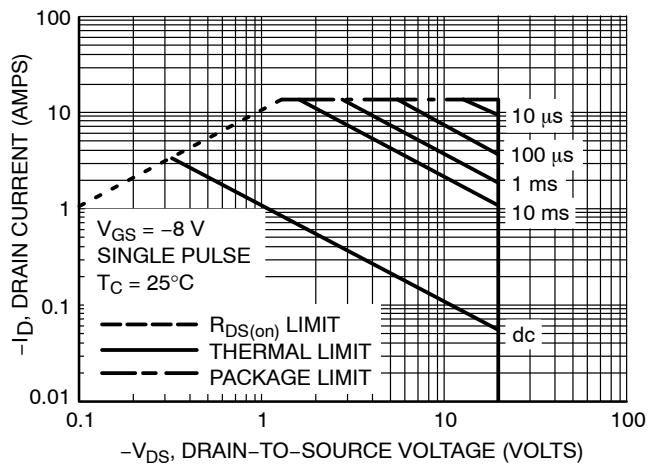

Figure 27. Maximum Rated Forward Biased Safe Operating Area

Operational Description

The NUS6160 provides overvoltage protection for positive voltages up to 20 V. A P-Channel FET protects the load connected on the Vout pin, against positive overvoltage conditions. The Output follows the VBUS level until OVLO threshold is reached.

Undervoltage Lockout (UVLO)

To ensure proper operation under all conditions, the device has a built-in undervoltage lock out (UVLO) circuit. As the input ramps from 0 V, the output remains disconnected from input until the Vin voltage is above 3.2 V nominal. The FLAG output is pulled to low as long as Vin does not reach the UVLO threshold. This circuit incorporates hysteresis on the UVLO pin to provide noise immunity to transient condition.

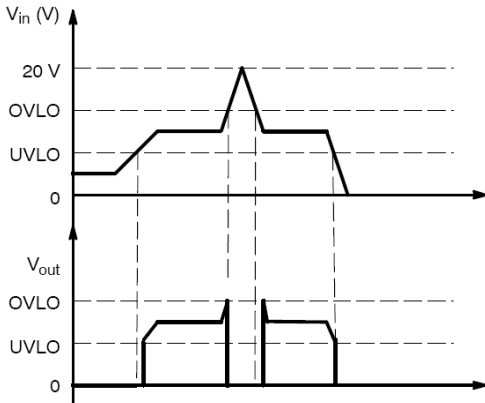

Figure 28. Output Characteristic vs. Vin

Overvoltage Lockout (OVLO)

To protect connected systems on Vout Pin from overvoltage, the device has a built-in overvoltage lock out (OVLO) circuit. During an overvoltage condition, the output remains disabled until the input voltage is reduced to below the OVLO hysteresis level. The FLAG output is tied to low until Vin is higher than OVLO. This circuit incorporates hysteresis on the OVLO pin to provide noise immunity from transient conditions.

FLAG Output

The NUS6160 provides a FLAG output, which alerts external systems that a fault has occurred. This pin goes low as soon as the OVLO threshold is exceeded. When Vin level recovers to its normal range the FLAG is set high.

The FLAG Pin is an open drain output, thus a pullup resistor (typically 1 MΩ – Minimum 10 kΩ) must be provided to Vbattery.

EN Input

To enable normal operation, the EN pin shall be forced low or connected to ground. A high level on the pin disconnects the OUT Pin from IN Pin. EN does not override an OVLO or UVLO fault.

Internal PMOS FET

The NUS6160 includes an internal PMOS FET which connects the input to the output pin. This FET is turned off

in the event of an overvoltage condition to protect the output from a positive overvoltage condition. The low Rds(on), during normal operation will minimize the voltage drop across the device. (See Figure 16).

ESD Tests

The NUS6160 meets the requirements of the IEC61000-4-2, level 4 (Input pin, 1 μF mounted on board). For the air discharge condition, Vin is protected up to ± 15 kV. In the contact condition, Vin is protected up to ±8 kV ESD. Please refer to Figure 29 to see the IEC 61000-4-2 electrostatic discharge waveform.

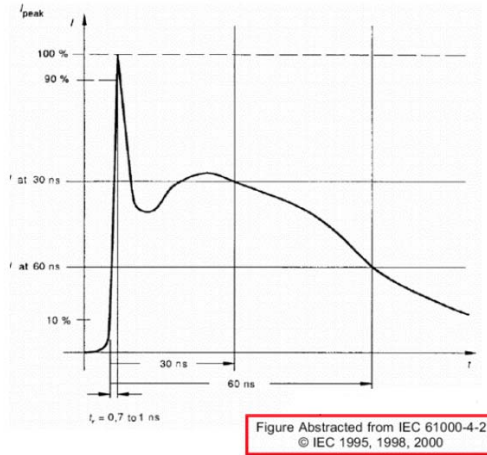

Figure 29. IEC 61000-4-2 Curve

Thermal Impedance

Due to cross heating of the three dice in the package, the equivalent thetas are given for this device rather than the individual thetas. To calculate the junction temperatures of a single die, the total power must be used. For example, given the following parameters, the die temperatures will be as shown:

- I_{dc} = 500 mA
- R_{DS(on) OVP} = 305 mΩ
- R_{DS(on) FETsw} = 72 mΩ
- FET_{reg} has a 1.0 V Drop
- Board copper area = 161 mm²

Calculate the individual power dissipations:

$$P_{OVP} = (0.50 \text{ A})^2 \times .305 \Omega = 0.076 \text{ W}$$

$$P_{SW} = (0.50 \text{ A})^2 \times .072 \Omega = 0.018 \text{ W}$$

$$P_{REG} = 0.50 \text{ A} \times 1.0 \text{ V} = 0.50 \text{ W}$$

$$P_{TOT} = 0.076 + 0.018 + 0.50 = 0.594 \text{ W}$$

From the Maximum ratings table for thetas, 161 mm² and 1 V drop across FET_{REG}:

- OVP FET 53°C/W
- FET_{SW} 49°C/W
- FET_{REG} 92°C/W

The die temperature rises above ambient are:

$$T_{OVP} = 53^\circ\text{C/W} \times 0.594 \text{ W} = 32^\circ\text{C}$$

$$T_{SW} = 49^\circ\text{C/W} \times 0.594 \text{ W} = 29^\circ\text{C}$$

$$T_{REG} = 92^\circ\text{C/W} \times 0.594 \text{ W} = 55^\circ\text{C}$$

NUS6160MN

PACKAGE DIMENSIONS

QFN22, 3x4, 0.5P
CASE 485AT-01
ISSUE B

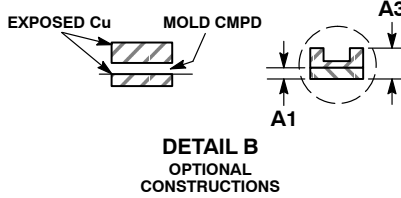
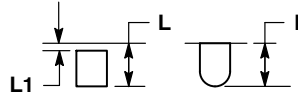
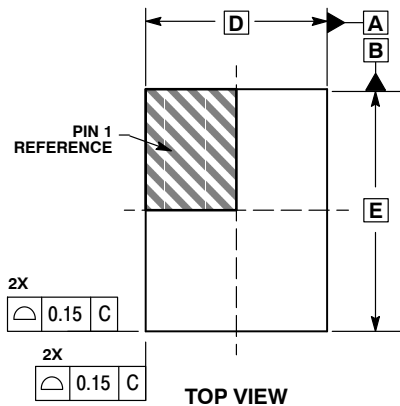

NOTES:

1. DIMENSIONING AND TOLERANCING PER ASME Y14.5M, 1994.
2. CONTROLLING DIMENSION: MILLIMETERS.
3. DIMENSION b APPLIES TO PLATED TERMINAL AND IS MEASURED BETWEEN 0.15 AND 0.30 MM FROM TERMINAL TIP.
4. COPLANARITY APPLIES TO THE EXPOSED PADS AS WELL AS THE TERMINALS.

DIM	MILLIMETERS		
	MIN	NOM	MAX
A	0.80	0.90	1.00
A1	0.00	0.025	0.05
A3	0.20 REF		
b	0.20	0.25	0.30
D	3.00 BSC		
D2	1.45	1.50	1.55
D3	0.52	0.57	0.62
D4	1.02	1.07	1.12
E	4.00 BSC		
E2	1.05	1.10	1.15
E3	1.30	1.35	1.40
E4	1.40	1.45	1.50
e	0.50 BSC		
K	0.25	---	---
L	0.30	0.325	0.35
L1	---	---	0.15
G	1.35	1.40	1.50
G1	0.95	1.05	1.15
G2	0.855	0.885	0.915

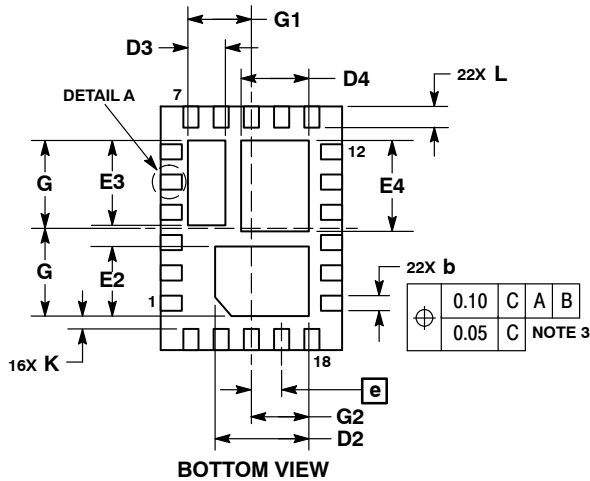
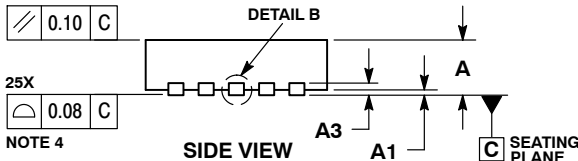

SOLDERING FOOTPRINT*

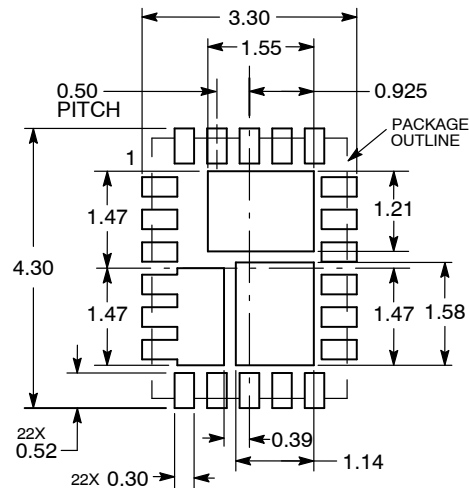

*For additional information on our Pb-Free strategy and soldering details, please download the ON Semiconductor Soldering and Mounting Techniques Reference Manual, SOLDERRM/D.

ON Semiconductor and are registered trademarks of Semiconductor Components Industries, LLC (SCILLC). SCILLC reserves the right to make changes without further notice to any products herein. SCILLC makes no warranty, representation or guarantee regarding the suitability of its products for any particular purpose, nor does SCILLC assume any liability arising out of the application or use of any product or circuit, and specifically disclaims any and all liability, including without limitation special, consequential or incidental damages. "Typical" parameters which may be provided in SCILLC data sheets and/or specifications can and do vary in different applications and actual performance may vary over time. All operating parameters, including "Typicals" must be validated for each customer application by customer's technical experts. SCILLC does not convey any license under its patent rights nor the rights of others. SCILLC products are not designed, intended, or authorized for use as components in systems intended for surgical implant into the body, or other applications intended to support or sustain life, or for any other application in which the failure of the SCILLC product could create a situation where personal injury or death may occur. Should Buyer purchase or use SCILLC products for any such unintended or unauthorized application, Buyer shall indemnify and hold SCILLC and its officers, employees, subsidiaries, affiliates, and distributors harmless against all claims, costs, damages, and expenses, and reasonable attorney fees arising out of, directly or indirectly, any claim of personal injury or death associated with such unintended or unauthorized use, even if such claim alleges that SCILLC was negligent regarding the design or manufacture of the part. SCILLC is an Equal Opportunity/Affirmative Action Employer. This literature is subject to all applicable copyright laws and is not for resale in any manner.

PUBLICATION ORDERING INFORMATION

LITERATURE FULFILLMENT:
Literature Distribution Center for ON Semiconductor
P.O. Box 5163, Denver, Colorado 80217 USA
Phone: 303-675-2175 or 800-344-3860 Toll Free USA/Canada
Fax: 303-675-2176 or 800-344-3867 Toll Free USA/Canada
Email: orderlit@onsemi.com

N. American Technical Support: 800-282-9855 Toll Free USA/Canada
Europe, Middle East and Africa Technical Support:
Phone: 421 33 790 2910
Japan Customer Focus Center
Phone: 81-3-5773-3850

ON Semiconductor Website: www.onsemi.com
Order Literature: <http://www.onsemi.com/orderlit>

For additional information, please contact your local Sales Representative