

8-CH Darlington Sink Driver

CH-D3815PB

Description

The CH-D3815 is high-voltage, high current darlington drivers comprised of eight NPN darlington pairs. Applications include relay, hammer, lamp and display(LED).

Features

- Output current (single output) 200mA Max.
- High sustaining voltage output, 15V Min.
- Inputs compatible with various types of logic.

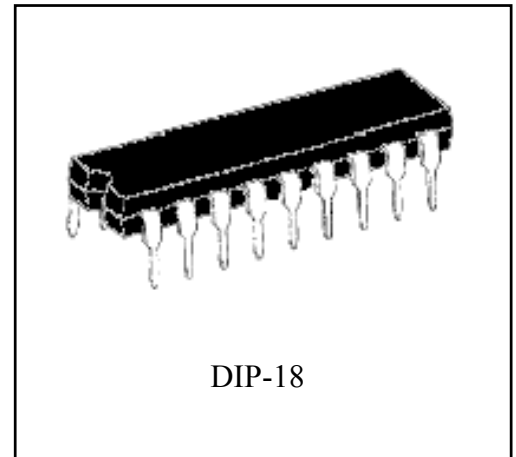

Pin Connection (top view)

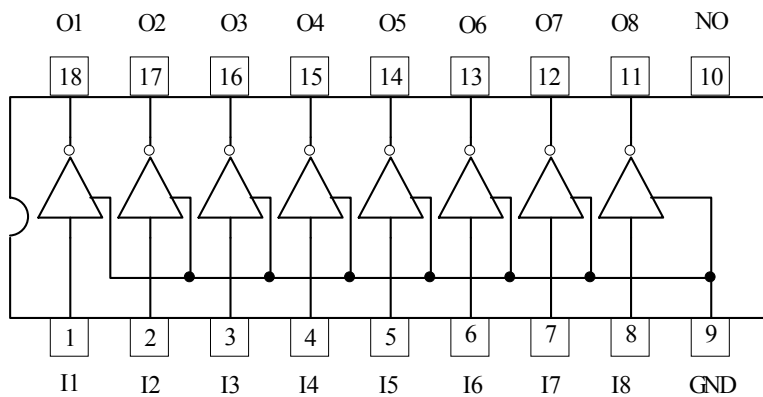

Schematics (Each Driver)

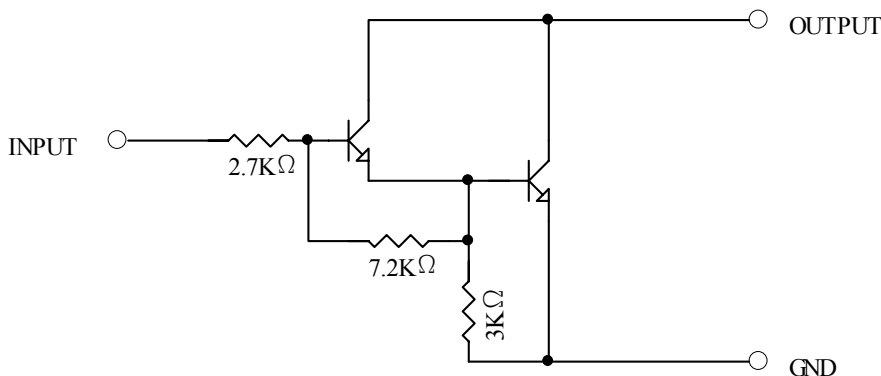



Maximum Ratings (Ta=25°C)

Characteristic	Symbol	Rating	Unit
Output Sustaining Voltage	V _{CE(SUS)}	-0.5~15	V
Output Current	I _{OUT}	200	mA/CH
Input Voltage	V _{IN}	-0.5~12	V
Power Dissipation	P _D	1.47	W
Operating Temperature	Topr	-40~+85	°C
Storage Temperature	Tstg	-55~+150	°C

Recommended Operating Conditions (Ta=-40~+85°C)

Characteristic	Symbol	Test Condition	Min	Typ	Max	Unit	
Output Sustaining Voltage	V _{CE(SUS)}		0	-	15	V	
Output Current	I _{OUT}	Tp _w =25ms, 8 Circuits, Ta=85°C, Tj=120°C	Duty=10%	-	-	150	mA/ch
			Duty=50%	-	-	50	
Input Voltage	V _{IN}		0	-	12	V	
Input Voltage(Output On)	V _{IN(ON)}	I _{OUT} =150mA, h _{FE} =800	2.8	-	12	V	
Input Voltage(Output Off)	V _{IN(OFF)}		0	-	0.7	V	
Power Dissipation	P _D	Ta=85°C	-	-	0.76	W	

Electrical Characteristics (Ta=25°C, unless otherwise noted)

Characteristic	Symbol	Test Circuit	Test Conditions	Min	Typ	Max	Unit
Output Leakage Current	I _{CEX}	1	V _{CE} =10V, Ta=25°C	-	-	50	μA
			V _{CE} =10V, Ta=85°C	-	-	100	
Collector-Emitter Saturation Voltage	V _{CE(sat)}	2	I _{OUT} =100mA, I _{IN} =250μA	-	-	1.35	V
			I _{OUT} =150mA, I _{IN} =400μA	-	-	1.65	V
DC Current Transfer Ratio	h _{FE}	2	V _{CE} =2V, I _{OUT} =150mA	1000	-	-	-
Input Current (Output On)	I _{IN(ON)}	3	I _{IN} =2.4V, I _{OUT} =150mA		0.4	0.7	mA
Input Current (Output Off)	I _{IN(OFF)}	4	I _{OUT} =500μA, Ta=85°C	50	65		μA
Input Voltage (Output On)	V _{IN(ON)}	5	V _{CE} =2V, h _{FE} =800, I _{OUT} =150mA			2.4	V
Input Capacitance	C _{IN}	-		-	15	-	pF
Turn-On Delay	t _{ON}	6	V _{OUT} =10V, R _L =125Ω, C _L =15pF	-	0.1	-	μs
Turn-Off Delay	t _{OFF}	6	V _{OUT} =10V, R _L =125Ω, C _L =15pF	-	0.2	-	

Test Circuit

1. ICEX

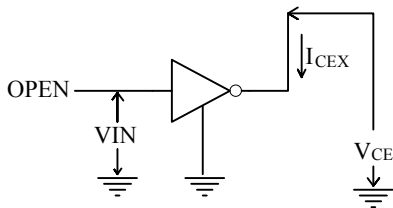

2. VCE(sat), hFE

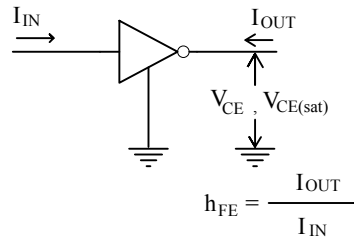

3. IIN(ON)

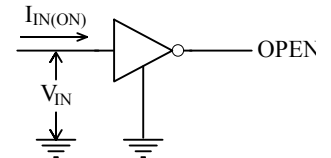

4. IIN(OFF)

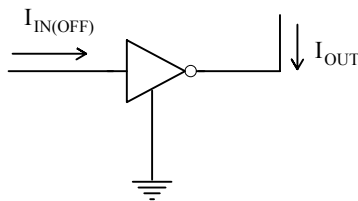

5. VIN(ON)

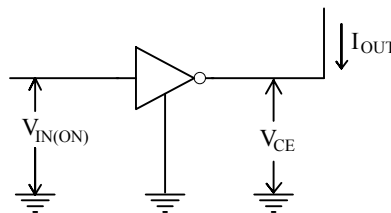

6. t_{ON} , t_{OFF}

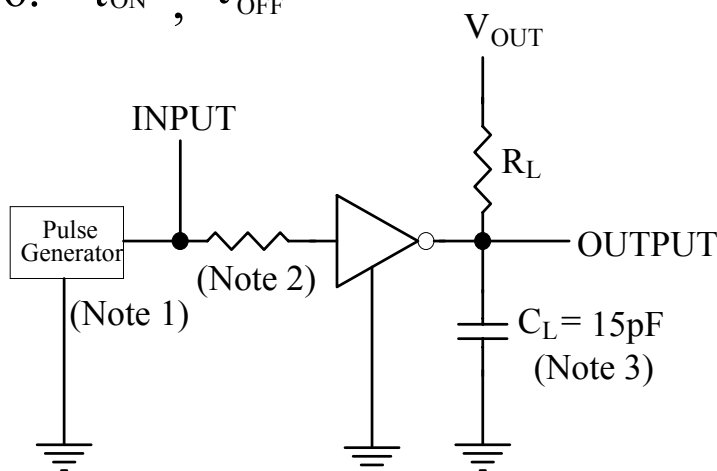

- Note 1: Pulse width 50 μs, duty cycle 10%
Output impedance 50 Ω, tr ≤ 5ns, tf ≤ 10ns
- Note 2: Input condition R1=0, VIH=3V
- Note 3: CL includes probe and jig capacitance

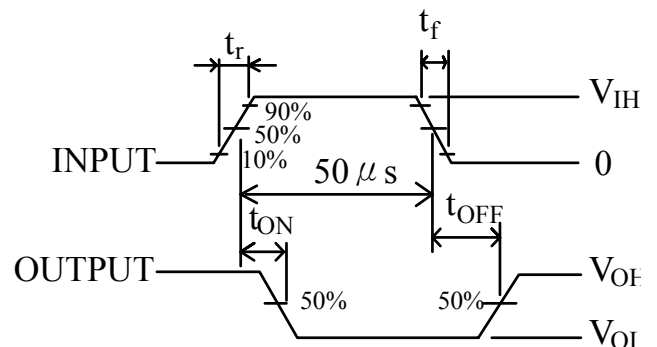



Precautions for Using

This IC does not include built-in protection circuits for excess current or overvoltage. If this IC is subjected to excess current or overvoltage, it may be destroyed. Hence, the utmost care must be taken when systems which incorporate this IC are designed. Utmost care is necessary in the design of the output line And GND line since IC may be destroyed due to short-circuit between outputs, air contamination fault, or fault by improper grounding.



Characteristic Curves

Output Current vs Input Current

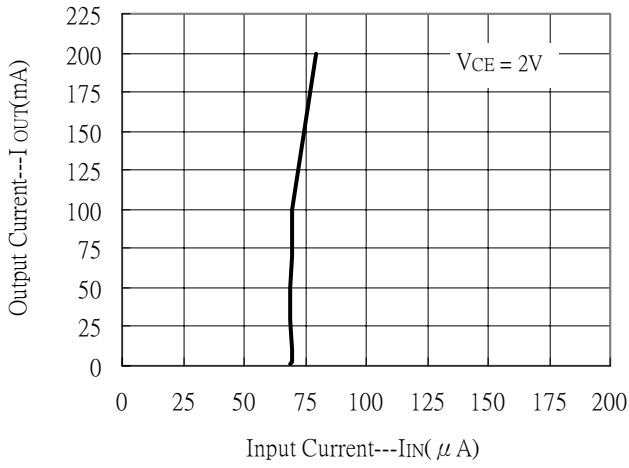

Saturation Voltage vs Output Current

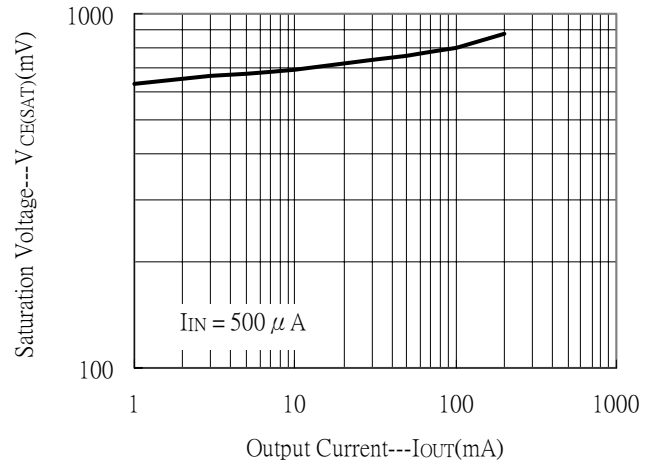

Current Gain vs Output Current

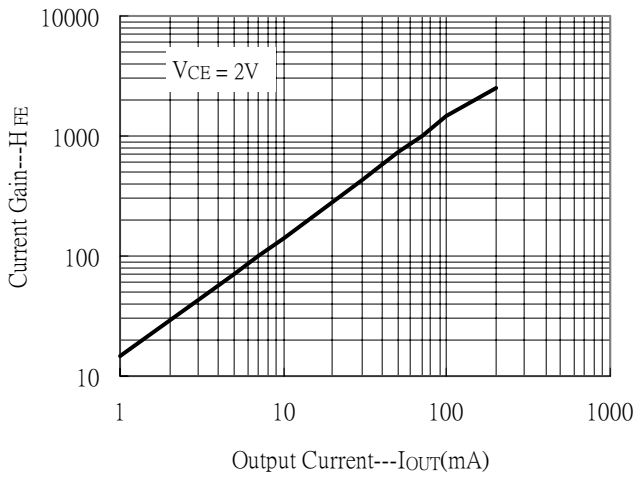

Input Current vs Input Voltage

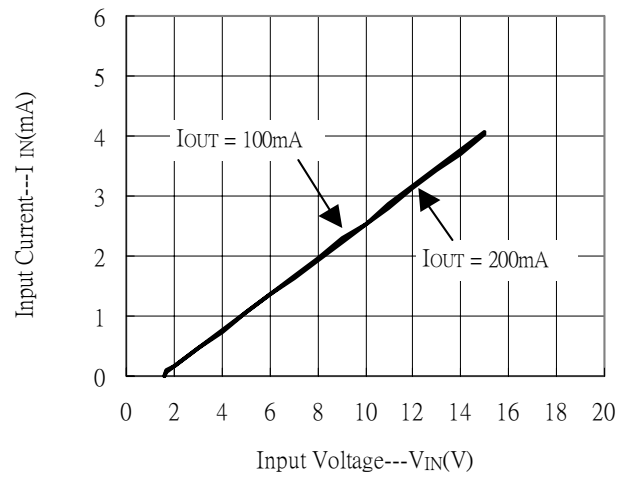

DIP-18 Dimension

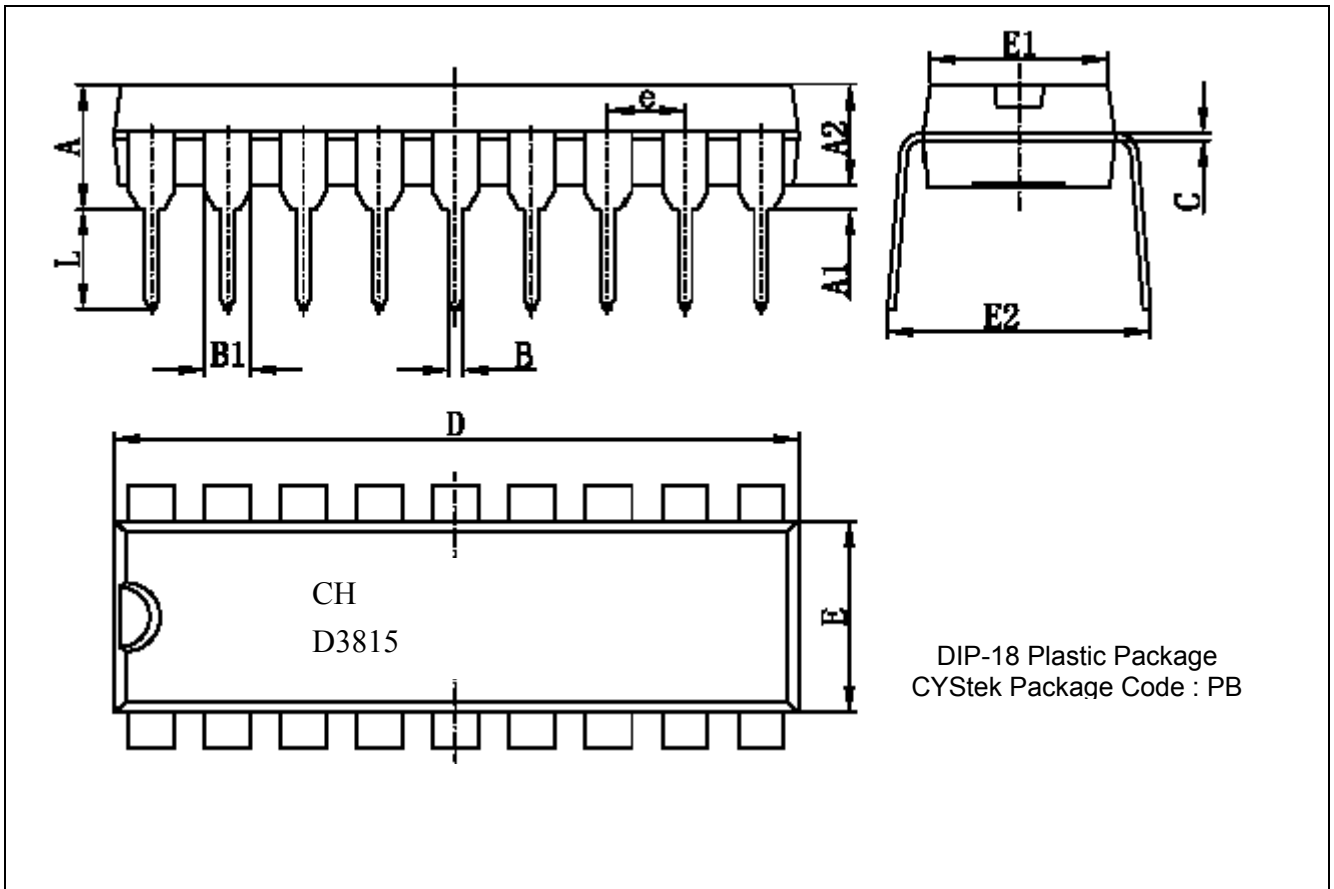

*:Typical

DIM	Inches		Millimeters		DIM	Inches		Millimeters	
	Min.	Max.	Min.	Max.		Min.	Max.	Min.	Max.
A	0.146	0.170	3.710	4.310	D	0.891	0.907	22.640	23.040
A1	0.020	-	0.510	-	E	0.244	0.260	6.200	6.600
A2	0.126	0.142	3.200	3.600	E1	0.300(typ)		7.620(typ)	
B	0.014	0.022	0.360	0.560	e	0.100(typ)		2.540(typ)	
B1	0.060(typ)		1.524(typ)		L	0.118	0.142	3.000	3.600
C	0.008	0.014	0.204	0.360	E2	0.323	0.370	8.200	9.400

Notes : 1.Controlling dimension : millimeters.
 2.Maximum lead thickness includes lead finish thickness, and minimum lead thickness is the minimum thickness of base material.
 3.If there is any question with packing specification or packing method, please contact your local CYStek sales office.

Material :

- Lead : 42 Alloy ; solder plating
- Mold Compound : Epoxy resin family, flammability solid burning class:UL94V-0

Important Notice:

- All rights are reserved. Reproduction in whole or in part is prohibited without the prior written approval of CYStek.
- CYStek reserves the right to make changes to its products without notice.
- CYStek **semiconductor products are not warranted to be suitable for use in Life-Support Applications, or systems.**
- CYStek assumes no liability for any consequence of customer product design, infringement of patents, or application assistance.