

**Dual buck chopper  
Super Junction MOSFET  
SiC chopper diode**

**$V_{DSS} = 900V$**   
 **$R_{DSon} = 120m\Omega \text{ max @ } T_j = 25^\circ C$**   
 **$I_D = 30A \text{ @ } T_c = 25^\circ C$**

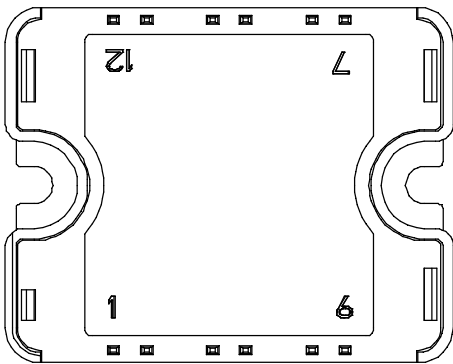
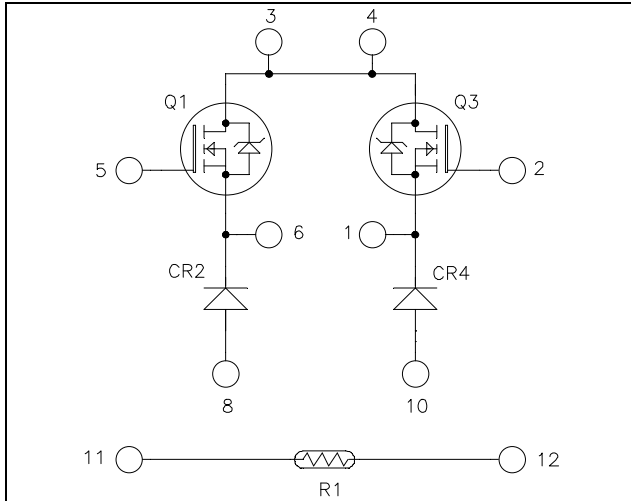

Pins 3/4 must be shorted together

### Application

- AC and DC motor control
- Switched Mode Power Supplies

### Features

- **COOLMOS**  
Power Semiconductors
  - Ultra low  $R_{DSon}$
  - Low Miller capacitance
  - Ultra low gate charge
  - Avalanche energy rated
  - Very rugged
- **SiC Schottky Diode**
  - Zero reverse recovery
  - Zero forward recovery
  - Temperature Independent switching behavior
  - Positive temperature coefficient on VF
- Very low stray inductance
  - Symmetrical design
- Internal thermistor for temperature monitoring
- High level of integration

### Benefits

- Outstanding performance at high frequency operation
- Direct mounting to heatsink (isolated package)
- Low junction to case thermal resistance
- Solderable terminals both for power and signal for easy PCB mounting
- Low profile
- RoHS Compliant

### Absolute maximum ratings

Symbol	Parameter	Max ratings	Unit
$V_{DSS}$	Drain - Source Breakdown Voltage	900	V
$I_D$	Continuous Drain Current	$T_c = 25^\circ C$	30
		$T_c = 80^\circ C$	23
$I_{DM}$	Pulsed Drain current	75	A
$V_{GS}$	Gate - Source Voltage	$\pm 20$	V
$R_{DSon}$	Drain - Source ON Resistance	120	$m\Omega$
$P_D$	Maximum Power Dissipation	$T_c = 25^\circ C$	250
$I_{AR}$	Avalanche current (repetitive and non repetitive)	8.8	A
$E_{AR}$	Repetitive Avalanche Energy	2.9	mJ
$E_{AS}$	Single Pulse Avalanche Energy	1940	

**CAUTION:** These Devices are sensitive to Electrostatic Discharge. Proper Handling Procedures Should Be Followed. See application note APT0502 on [www.microsemi.com](http://www.microsemi.com)

All ratings @  $T_j = 25^\circ\text{C}$  unless otherwise specified

**Electrical Characteristics**

Symbol	Characteristic	Test Conditions	Min	Typ	Max	Unit
$I_{DSS}$	Zero Gate Voltage Drain Current	$V_{GS} = 0V, V_{DS} = 900V$   $T_j = 25^\circ\text{C}$			100	$\mu\text{A}$
		$V_{GS} = 0V, V_{DS} = 900V$   $T_j = 125^\circ\text{C}$		500		
$R_{DS(on)}$	Drain – Source on Resistance	$V_{GS} = 10V, I_D = 26A$		100	120	$\text{m}\Omega$
$V_{GS(th)}$	Gate Threshold Voltage	$V_{GS} = V_{DS}, I_D = 3\text{mA}$	2.5	3	3.5	V
$I_{GSS}$	Gate – Source Leakage Current	$V_{GS} = \pm 20V, V_{DS} = 0V$			100	$\text{nA}$

**Dynamic Characteristics**

Symbol	Characteristic	Test Conditions	Min	Typ	Max	Unit
$C_{iss}$	Input Capacitance	$V_{GS} = 0V ; V_{DS} = 100V$ $f = 1\text{MHz}$		6800		$\text{pF}$
$C_{oss}$	Output Capacitance			330		
$Q_g$	Total gate Charge	$V_{GS} = 10V$ $V_{Bus} = 400V$ $I_D = 26A$		270		$\text{nC}$
$Q_{gs}$	Gate – Source Charge			32		
$Q_{gd}$	Gate – Drain Charge			115		
$T_{d(on)}$	Turn-on Delay Time	<b>Inductive Switching (<math>125^\circ\text{C}</math>)</b> $V_{GS} = 10V$ $V_{Bus} = 600V$ $I_D = 26A$ $R_G = 7.5\Omega$		70		$\text{ns}$
$T_r$	Rise Time			20		
$T_{d(off)}$	Turn-off Delay Time			400		
$T_f$	Fall Time			25		
$E_{on}$	Turn-on Switching Energy	<b>Inductive switching @ <math>25^\circ\text{C}</math></b> $V_{GS} = 10V ; V_{Bus} = 600V$ $I_D = 26A ; R_G = 7.5\Omega$		900		$\mu\text{J}$
$E_{off}$	Turn-off Switching Energy			750		
$E_{on}$	Turn-on Switching Energy	<b>Inductive switching @ <math>125^\circ\text{C}</math></b> $V_{GS} = 10V ; V_{Bus} = 600V$ $I_D = 26A ; R_G = 7.5\Omega$		1278		$\mu\text{J}$
$E_{off}$	Turn-off Switching Energy			867		

**SiC chopper diode ratings and characteristics**

Symbol	Characteristic	Test Conditions	Min	Typ	Max	Unit
$V_{RRM}$	Maximum Peak Repetitive Reverse Voltage		1200			V
$I_{RM}$	Maximum Reverse Leakage Current	$V_R = 1200V$	$T_j = 25^\circ\text{C}$	32	200	$\mu\text{A}$
			$T_j = 175^\circ\text{C}$	56	1000	
$I_F$	DC Forward Current	$T_c = 100^\circ\text{C}$		10		A
$V_F$	Diode Forward Voltage	$I_F = 10A$	$T_j = 25^\circ\text{C}$	1.6	1.8	V
			$T_j = 175^\circ\text{C}$	2.3	3	
$Q_C$	Total Capacitive Charge	$I_F = 10A, V_R = 600V$ $di/dt = 500A/\mu\text{s}$		40		$\text{nC}$
C	Total Capacitance	$f = 1\text{MHz}, V_R = 200V$		96		$\text{pF}$
		$f = 1\text{MHz}, V_R = 400V$		69		

**Temperature sensor NTC** (see application note APT0406 on [www.microsemi.com](http://www.microsemi.com) for more information).

Symbol	Characteristic	Min	Typ	Max	Unit
R <sub>25</sub>	Resistance @ 25°C		50		kΩ
ΔR <sub>25</sub> /R <sub>25</sub>			5		%
B <sub>25/85</sub>	T <sub>25</sub> = 298.15 K		3952		K
ΔB/B	T <sub>C</sub> = 100°C		4		%

$$R_T = \frac{R_{25}}{\exp\left[B_{25/85}\left(\frac{1}{T_{25}} - \frac{1}{T}\right)\right]}$$

T: Thermistor temperature  
 R<sub>T</sub>: Thermistor value at T

## Thermal and package characteristics

Symbol	Characteristic	Min	Typ	Max	Unit	
R <sub>thJC</sub>	Junction to Case Thermal Resistance	CoolMOS		0.5	°C/W	
		SiC Diode		1.8		
V <sub>ISOL</sub>	RMS Isolation Voltage, any terminal to case t = 1 min, I <sub>isol</sub> < 1mA, 50/60Hz	4000			V	
T <sub>J</sub>	Operating junction temperature range	-40		150	°C	
T <sub>STG</sub>	Storage Temperature Range	-40		125		
T <sub>C</sub>	Operating Case Temperature	-40		100		
Torque	Mounting torque	To heatsink	M4	2.5	4.7	N.m
Wt	Package Weight			80		g

## SP1 Package outline (dimensions in mm)

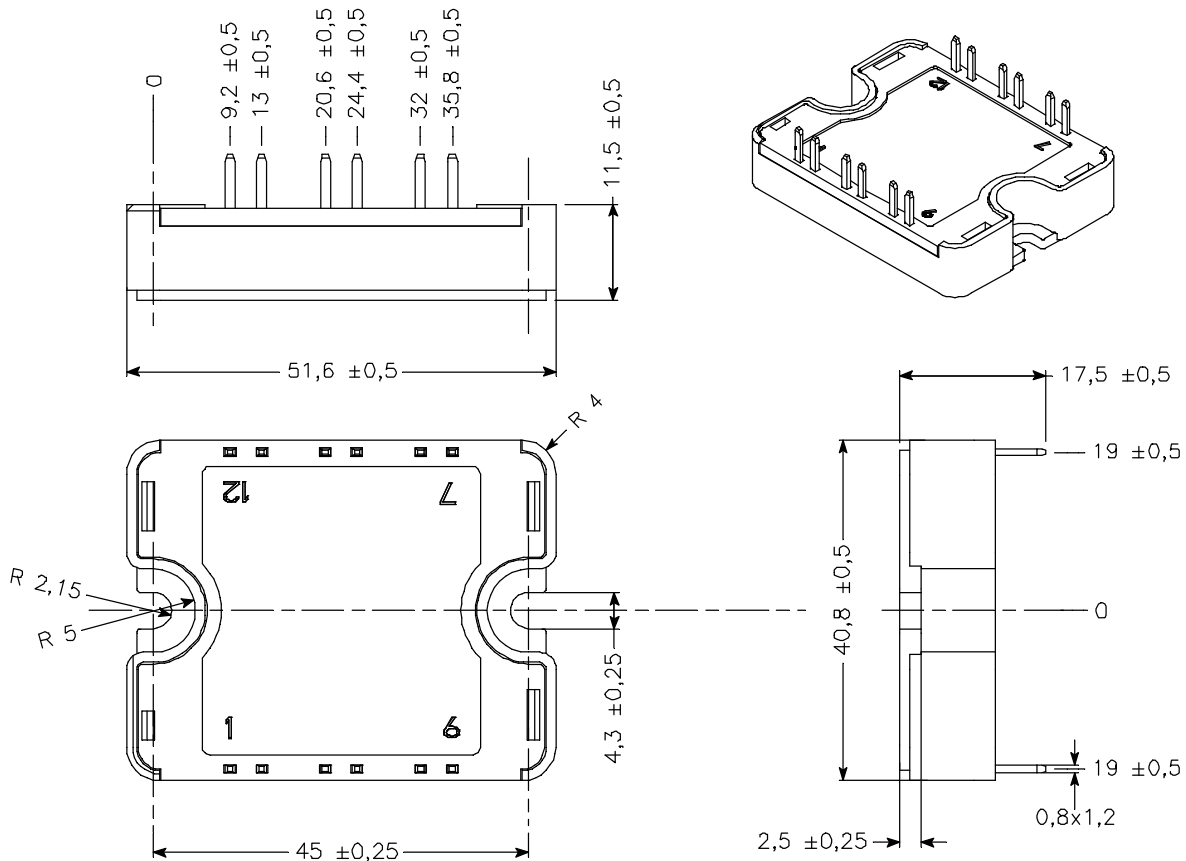

See application note 1904 - Mounting Instructions for SP1 Power Modules on [www.microsemi.com](http://www.microsemi.com)

## Typical CoolMOS Performance Curve

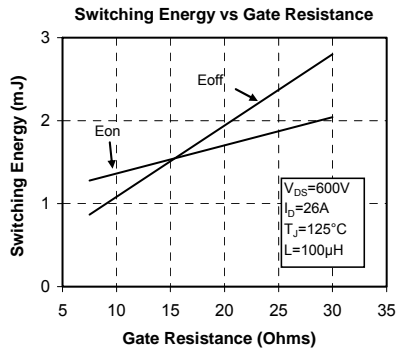
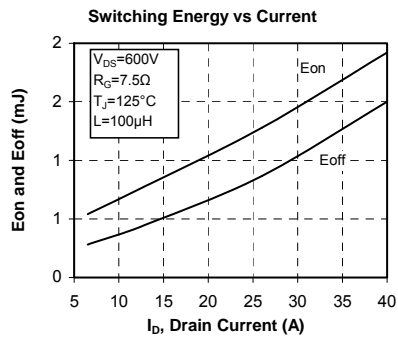
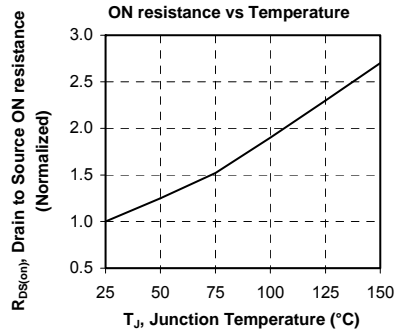
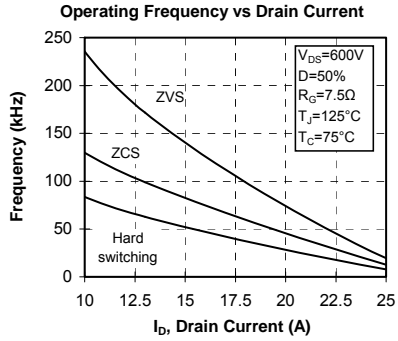

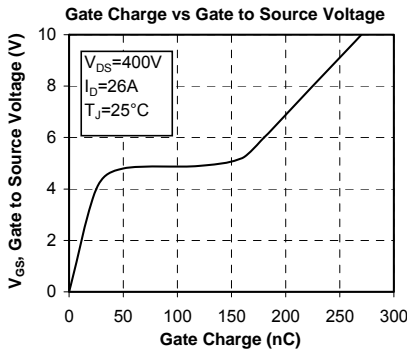
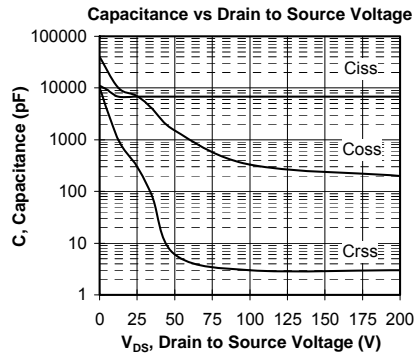
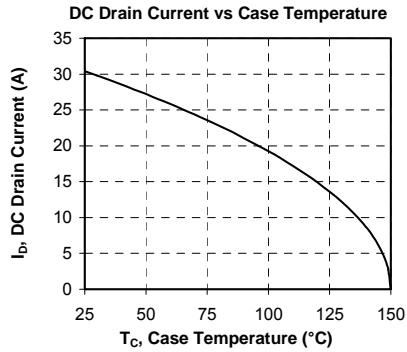
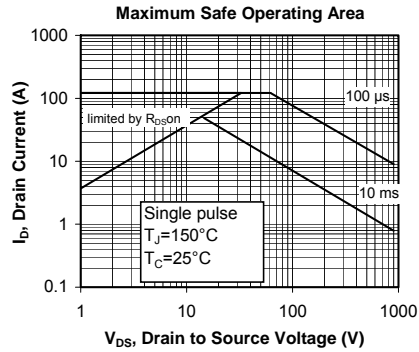
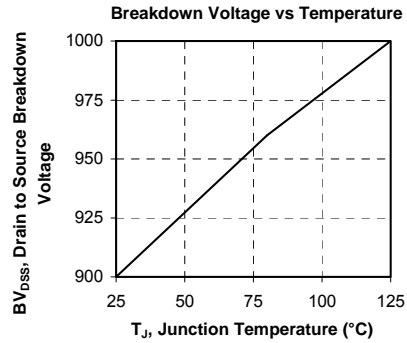
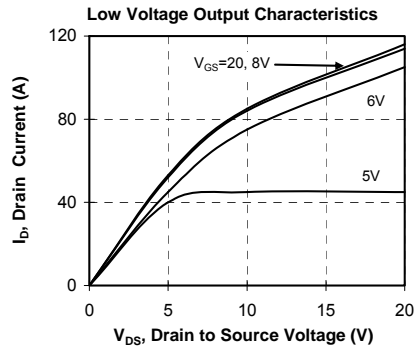
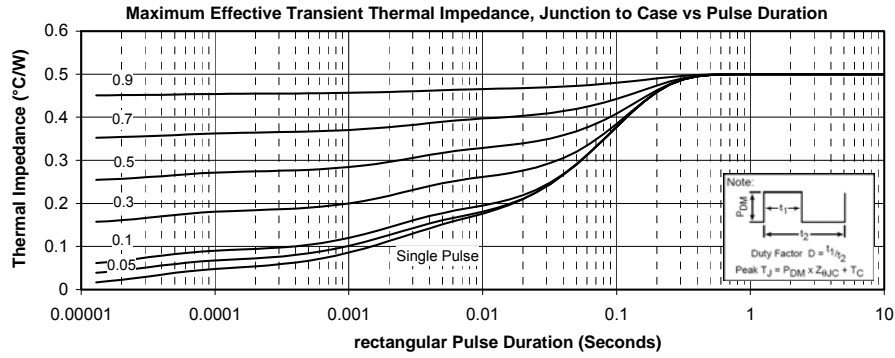

## Typical SiC Diode Performance Curve

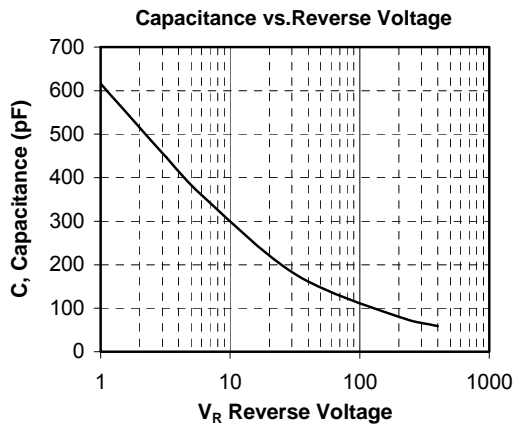
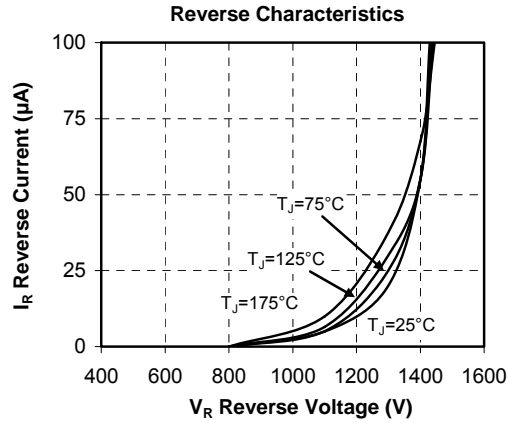
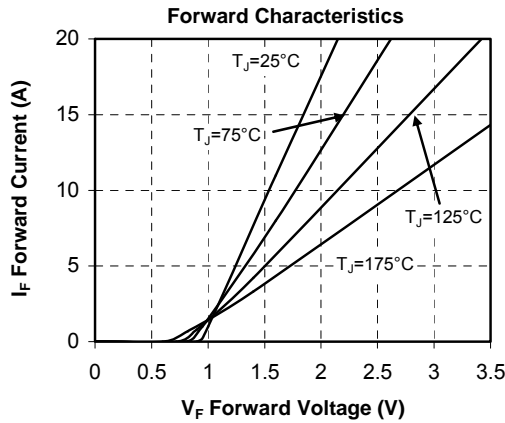
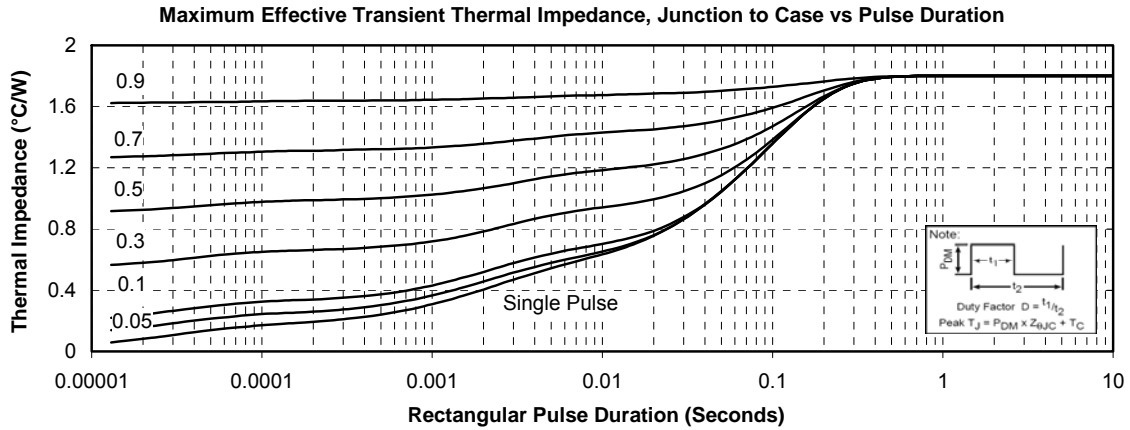

“COOLMOS™ comprise a new family of transistors developed by Infineon Technologies AG. “COOLMOS” is a trademark of Infineon Technologies AG”.

Microsemi reserves the right to change, without notice, the specifications and information contained herein

Microsemi's products are covered by one or more of U.S patents 4,895,810 5,045,903 5,089,434 5,182,234 5,019,522 5,262,336 6,503,786 5,256,583 4,748,103 5,283,202 5,231,474 5,434,095 5,528,058 6,939,743 7,352,045 5,283,201 5,801,417 5,648,283 7,196,634 6,664,594 7,157,886 6,939,743 7,342,262 and foreign patents. U.S and Foreign patents pending. All Rights Reserved.