

DATA SHEET

SKY65006-348LF: 2.4–2.5 GHz WLAN/Zigbee® Power Amplifier

Features

- 2.4–2.5 GHz operation
- WLAN/Zigbee® applications
- Advanced GaAs HBT process
- Integrated output power detector and F2 filter
- Low voltage positive bias supply (3.3 V)
- Low quiescent current: 50 mA
- 27 dB small signal gain
- 802.11g linear power: 18 dBm (includes integrated filter loss)
- 802.11b mask-compliant power: 21 dBm (includes integrated filter loss)
- 802.15.4 mask-compliant power: 15.4 dBm (includes integrated filter loss)
- Low-cost plastic package QFN 16-pin (3 x 3 x 0.75 mm)
- Lead (Pb)-free, and RoHS-compliant

Description

The SKY65006-348LF is a linear, high-gain two-stage power amplifier with integrated output power detector and second harmonic (F2) filter, designed for low voltage operations. This device is manufactured on an advanced Gallium Arsenide (GaAs), Heterojunction Bipolar Transistor (HBT) process. It is designed for power amplifier applications in WLAN, Zigbee®, and spread spectrum systems from 2.4–2.5 GHz. The amplifier is packaged in a QFN-16, 3 x 3 x 0.75 mm package.

NEW

Skyworks offers lead (Pb)-free, RoHS (Restriction of Hazardous Substances)-compliant packaging.



Block Diagram

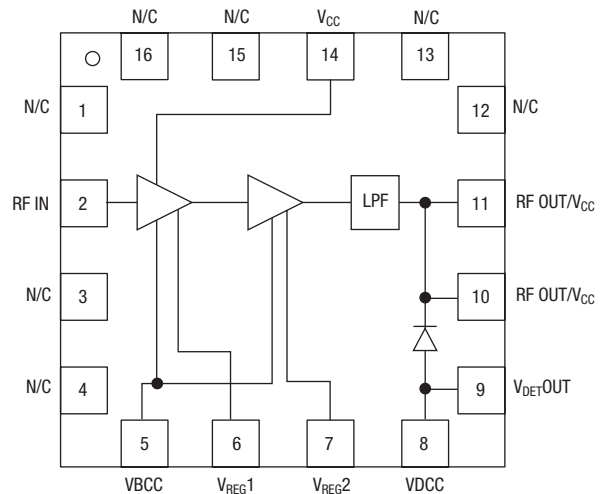

QFN-16 (3 x 3 mm)

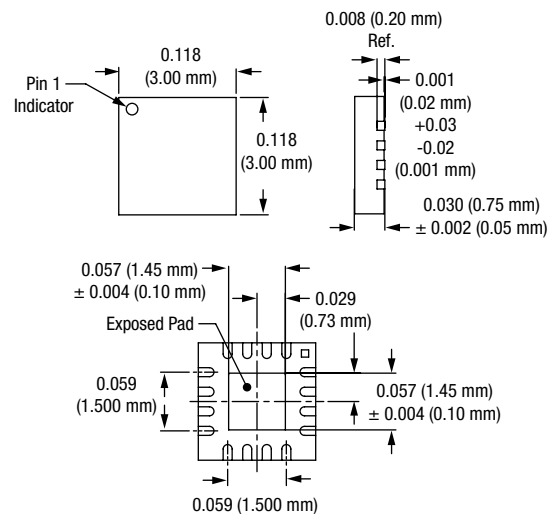

Pin Assignments

Pin	Symbol	Description
1, 3, 4, 12, 13, 15, 16	N/C	No connect
2	RF IN	RF input
5	VBCC	DC control voltage input that sets bias to the first and second amplifier stages.
6	V _{REG1}	DC control voltage input to regulate the current to the first amplifier stages.
7	V _{REG2}	DC control voltage input to regulate the current to the 2nd amplifier stage.
8	VDCC	Reference voltage input to power detector.
9	V _{DET}	Power detector output voltage.
10, 11	RF OUT/V _{CC}	RF outputs and supply voltage inputs to second amplifier stage. These pins must be connected directly together for current sharing.
14	V _{CC}	DC supply voltage input to the first amplifier stage.
Center	GND	Equipotential point. Connect package backside center paddle to the printed circuit board common via the lowest possible impedance.

DC Voltage Control Table

Mode	V _{CC}	V _{REG} (1)	VBCC	VDCC
RF IN-RF OUT	3.3 V	3.0 V	3.3 V	3.0 V

1. Voltage applied at evaluation board DC pins.

General RF Transmit Electrical Specifications

T_C = 25 °C, V_{CC} = 3.3 V, V_{REG} = 3 V, VDCC = 3 V

Parameter	Symbol	Condition	Min.	Typ.	Max.	Unit
Frequency range	F		2400		2500	MHz
Gain	S ₂₁	Small signal	26	27		dB
Gain variation over frequency	ΔS ₂₁	Small signal		0.2		dB
Input return loss	S ₁₁	Small signal		27		dB
Output return loss	S ₂₂	Small signal		6.5		dB
Output P ₁ dB	P ₁ dB	CW	23	24		dBm
2nd harmonic	F ₂	CW at P ₁ dB		-35		dBm
3rd harmonic	F ₃	CW at P ₁ dB		-49		dBm
Detector voltage	V _{DET}	P _{OUT} = 10 dBm, 802.11g modulation		0.4		V
Noise figure	NF	Small signal		6.2	7	dB
PAE @ P ₁ dB	PAE	CW at P ₁ dB	26	29		%
Quiescent current	I _{CQ}	(No RF signal)		53		mA
Reference current	I _{REF}	(No RF signal)		6		mA
I _{CC} @ P ₁ dB	I _{CC}	at P ₁ dB		265		mA

Absolute Maximum Ratings

Characteristic	Value
Supply voltage (V _{CC})	5 V
Supply current (I _{CC})	500 mA
Regulator supply voltage (V _{REG1} & V _{REG2})	< V _{CC} V
Operating temperature (T _C)	-40 °C to +85 °C
Storage temperature (T _{ST})	-55 °C to +125 °C
RF input power (P _{IN})	10 dBm
Junction temperature (T _J)	150 °C

Performance is guaranteed only under the conditions listed in the specifications table and is not guaranteed under the full range(s) described by the Absolute Maximum specifications. Exceeding any of the absolute maximum/minimum specifications may result in permanent damage to the device and will void the warranty. Each absolute maximum rating listed is an individual parameter. Biasing and driving the amplifier with more than one absolute maximum rating listed may result in permanent damage to the device. Exposure to maximum rating conditions for extended periods may reduce device reliability.

CAUTION: Although this device is designed to be as robust as possible, ESD (Electrostatic Discharge) can damage this device. This device must be protected at all times from ESD. Static charges may easily produce potentials of several kilovolts on the human body or equipment, which can discharge without detection. Industry-standard ESD precautions must be employed at all times.

802.11g Electrical Specifications**OFDM Modulation, 54 Mbps, $T_C = 25\text{ }^\circ\text{C}$, $V_{CC} = 3.3\text{ V}$, $V_{REG} = 3\text{ V}$, $V_{DCC} = 3\text{ V}$**

Parameter	Symbol	Condition	Min.	Typ.	Max.	Unit
Linear power at 2.442 GHz	P_{OUT}	54 Mbps at 3.5% EVM		17		dBm
Current consumption	I_{CC}	54 Mbps at linear power		130		mA
Detector voltage	V_{DET}	54 Mbps at linear power		1		V

802.11b Electrical Specifications**CCK Modulation, 11 Mbps, $T_C = 25\text{ }^\circ\text{C}$, $V_{CC} = 3.3\text{ V}$, $V_{REG} = 3\text{ V}$, $V_{DCC} = 3\text{ V}$**

Parameter	Symbol	Condition	Min.	Typ.	Max.	Unit
Compliant power at 2.442 GHz	P_{OUT}	11 Mbps		21.5		dBm
Current consumption	I_{CC}	11 Mbps at compliant power		190		mA
Detector voltage	V_{DET}	11 Mbps at compliant power		1.4		V

802.11b data is taken with a raised cosine filter and an alpha factor of 0.7.

802.15.4 Electrical Specifications**Zigbee® O-QPSK Modulation, 250 Kb/s, $T_C = 25\text{ }^\circ\text{C}$, $V_{CC} = 3.3\text{ V}$, $V_{REG} = 3\text{ V}$, $V_{DCC} = 3\text{ V}$**

Parameter	Symbol	Condition	Min.	Typ.	Max.	Unit
Compliant power at 2.442 GHz	P_{OUT}	250 Kb/s @ $P_{IN} = -12\text{ dBm}$		15.4		dBm
Power at 2.442 GHz	P_{OUT}	250 Kb/s @ $P_{IN} = -2\text{ dBm}$		25		dBm

Typical Performance Data

$V_{CC} = V_{BCC} = 3.3\text{ V}$, $V_{REF} = V_{DC} = 3\text{ V}$, $Z_0 = 50\ \Omega$, $T_C = 25\ ^\circ\text{C}$, Frequency = 2.442 GHz unless otherwise noted

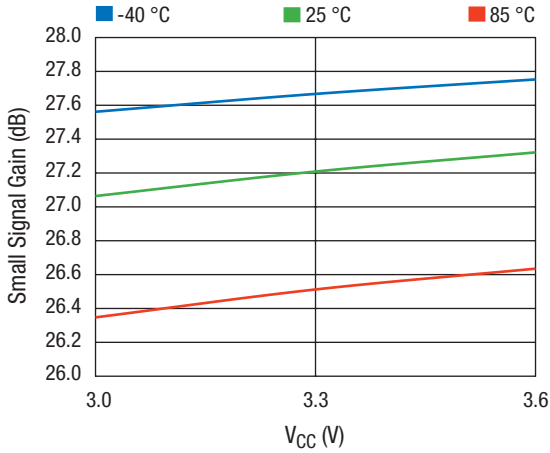

Small Signal Gain vs. V_{CC} Across Temperature

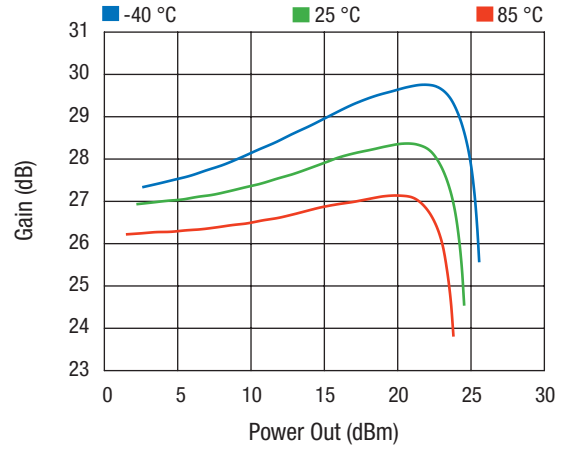

Gain vs. Power Out Across Temperature

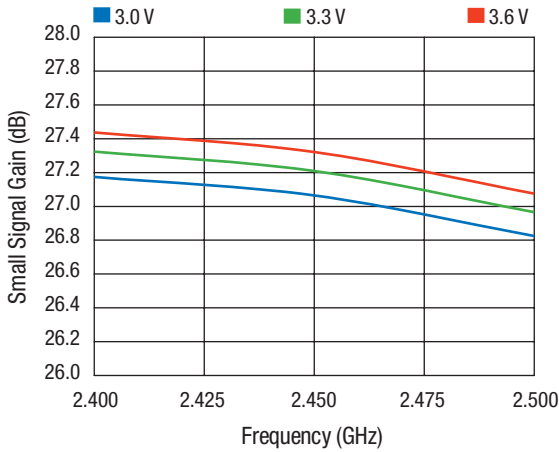

Small Signal Gain vs. Frequency Across V_{CC}

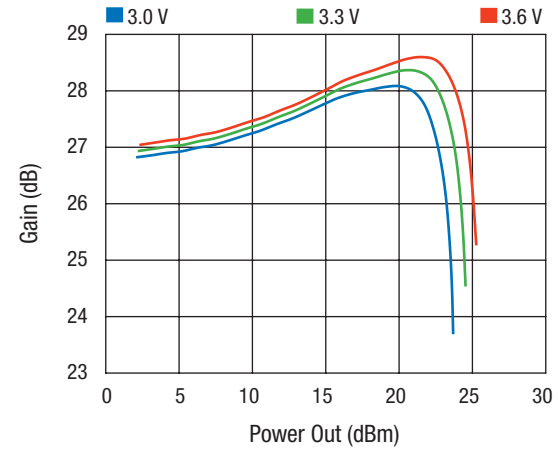

Gain vs. Power Out Across V_{CC}

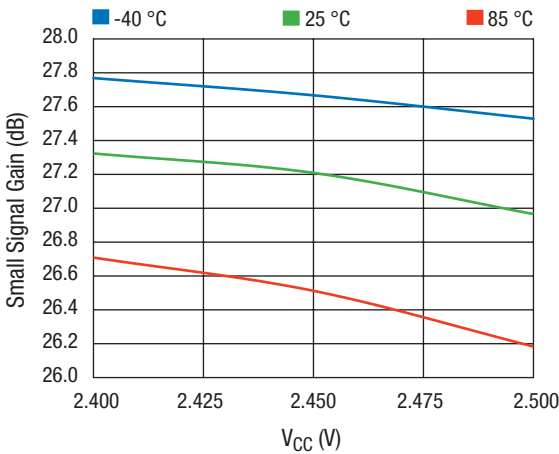

Small Signal Gain vs. Frequency Across Temperature

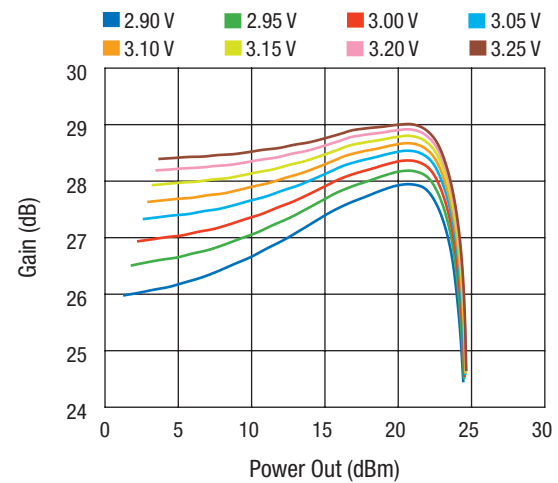

Gain vs. Power Out Across V_{REG}

Typical Performance Data

$V_{CC} = V_{BCC} = 3.3\text{ V}$, $V_{REF} = V_{DCC} = 3\text{ V}$, $Z_0 = 50\ \Omega$, $T_C = 25\ ^\circ\text{C}$, Frequency = 2.442 GHz unless otherwise noted

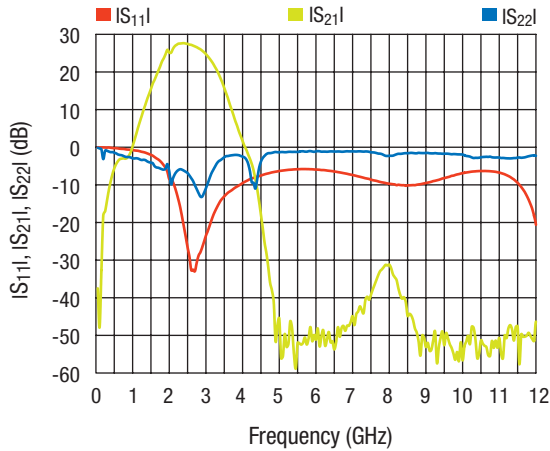

S-Parameters vs. Frequency

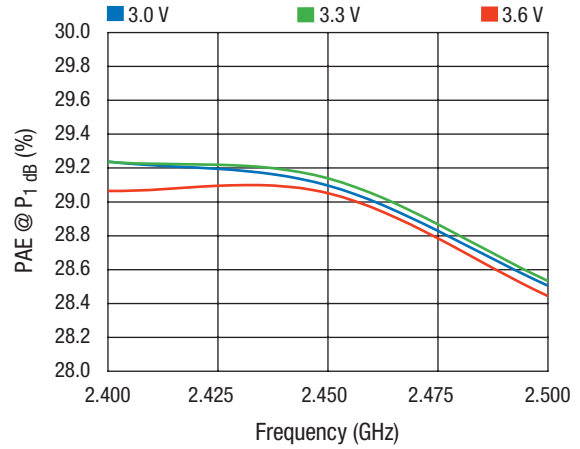

PAE @ P₁ dB vs. Frequency Across V_{CC}

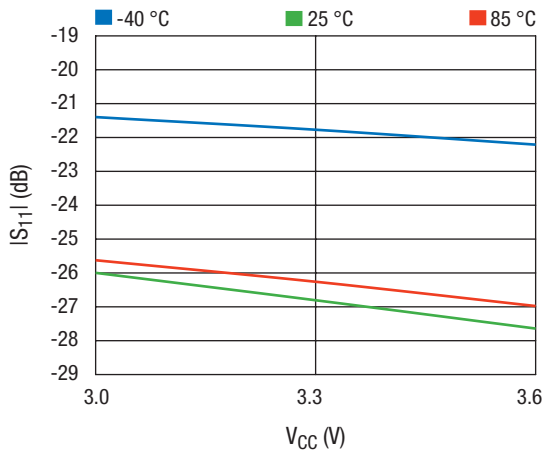

|S₁₁| vs. V_{CC} Across Temperature

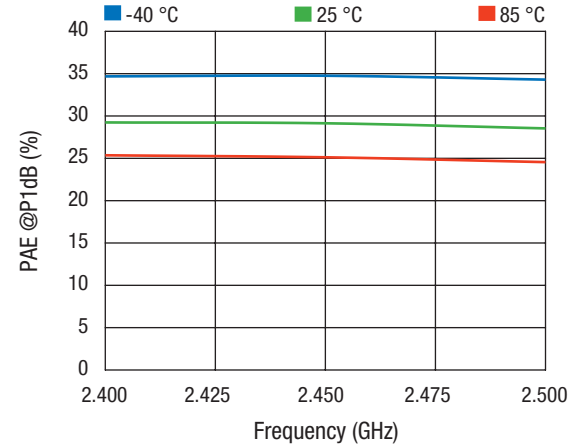

PAE @ P₁ dB vs. Frequency Across Temperature

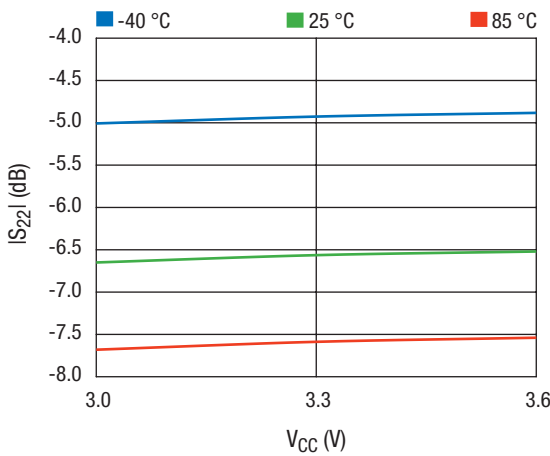

|S₂₂| vs. V_{CC} Across Temperature

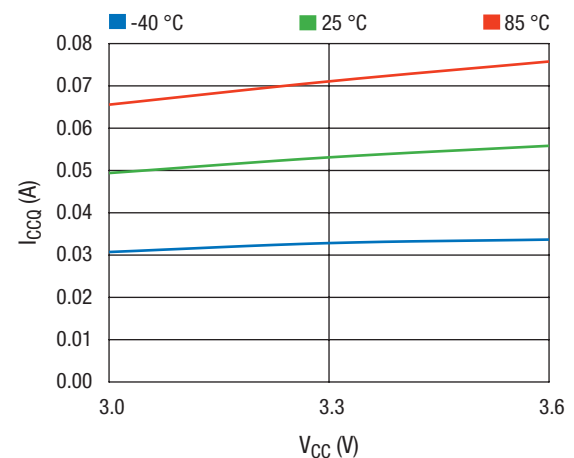

ICCC vs. V_{CC} Across Temperature

Typical Performance Data

$V_{CC} = V_{BCC} = 3.3\text{ V}$, $V_{REF} = V_{DCC} = 3\text{ V}$, $Z_0 = 50\ \Omega$, $T_C = 25\ ^\circ\text{C}$, Frequency = 2.442 GHz unless otherwise noted

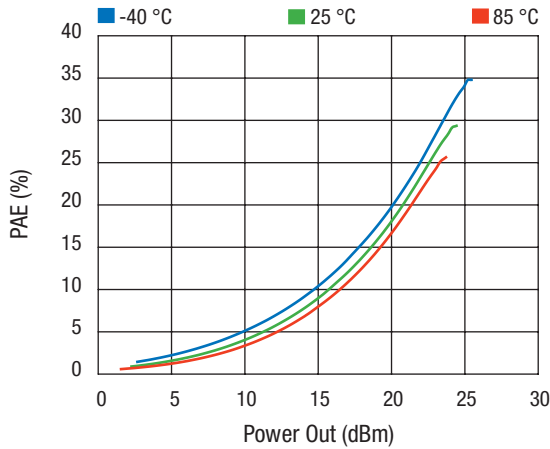

PAE @ P₁ dB vs. Power Out Across Temperature

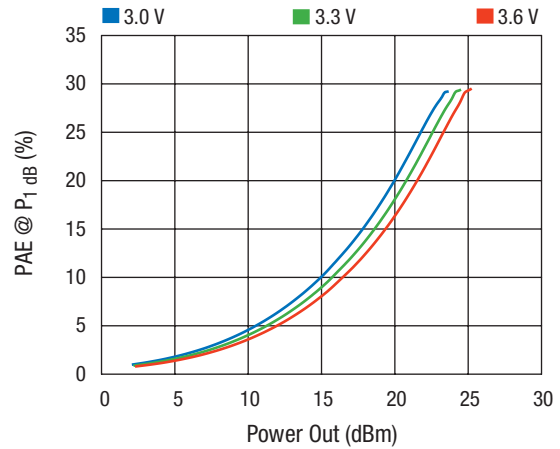

PAE @ P₁ dB vs. Power Out Across V_{CC}

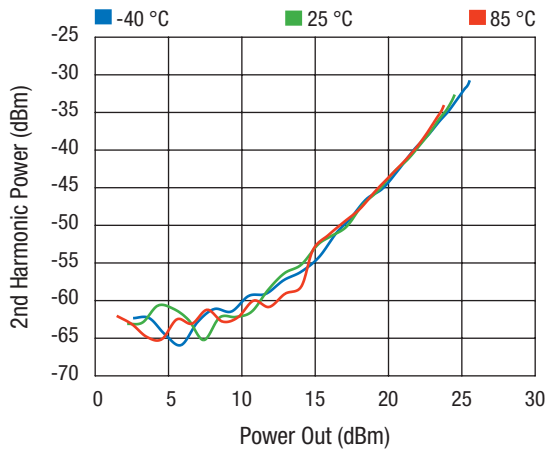

2nd Harmonic vs. Power Out Across Temperature

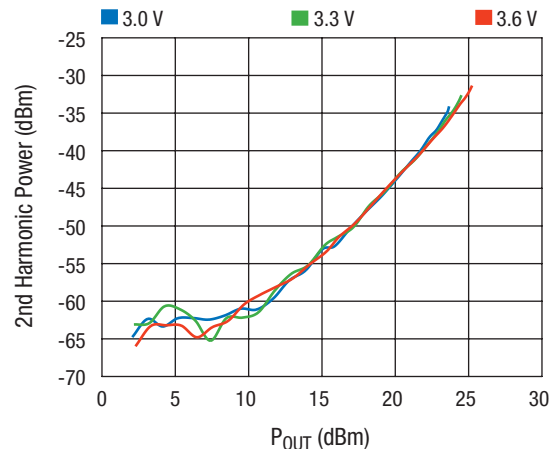

2nd Harmonic vs. Power Out Across V_{CC}

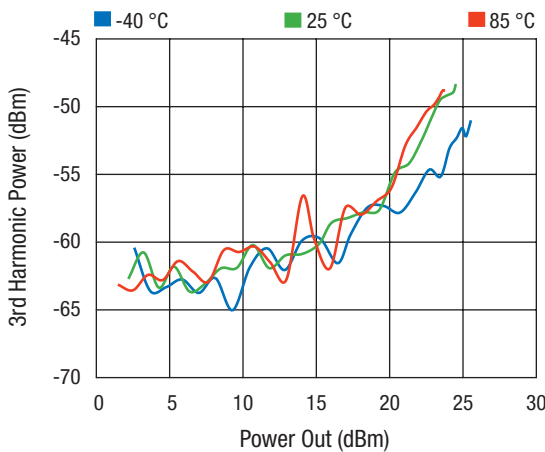

3rd Harmonic vs. Power Out Across Temperature

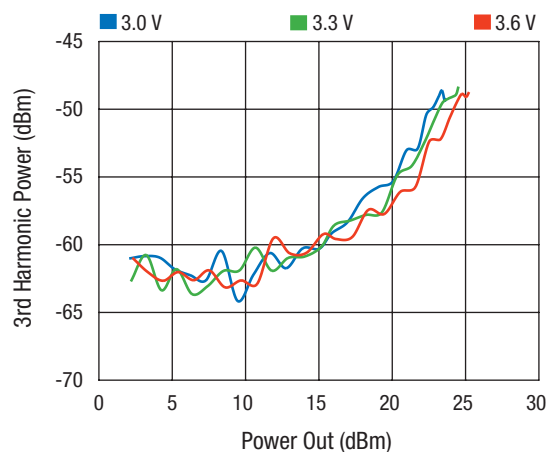

3rd Harmonic vs. Power Out Across V_{CC}

Typical Performance Data

$V_{CC} = V_{BCC} = 3.3\text{ V}$, $V_{REF} = V_{DCC} = 3\text{ V}$, $Z_0 = 50\ \Omega$, $T_C = 25\ ^\circ\text{C}$, Frequency = 2.442 GHz unless otherwise noted

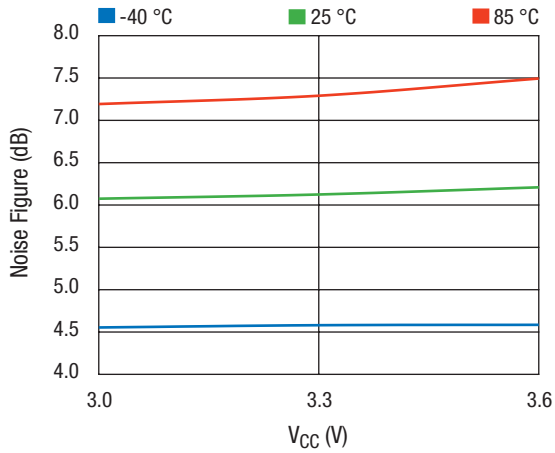

Noise Figure vs. V_{CC} Across Temperature

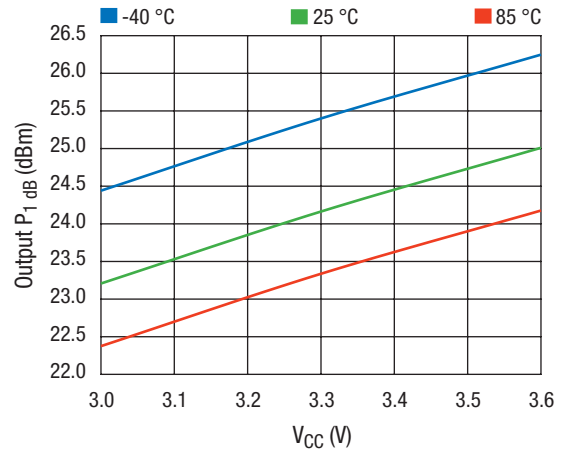

Output P₁ dB vs. V_{CC} Across Temperature

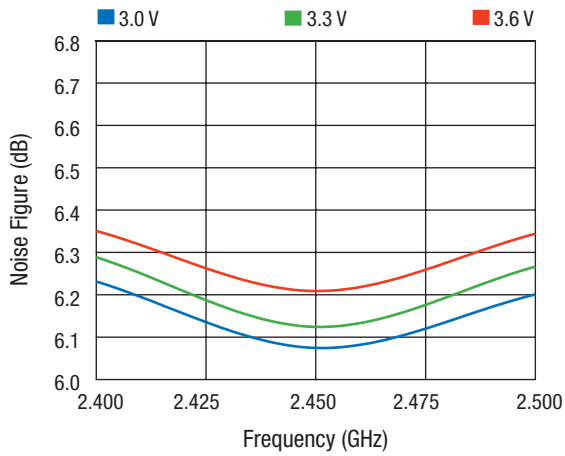

Noise Figure vs. Frequency Across V_{CC}

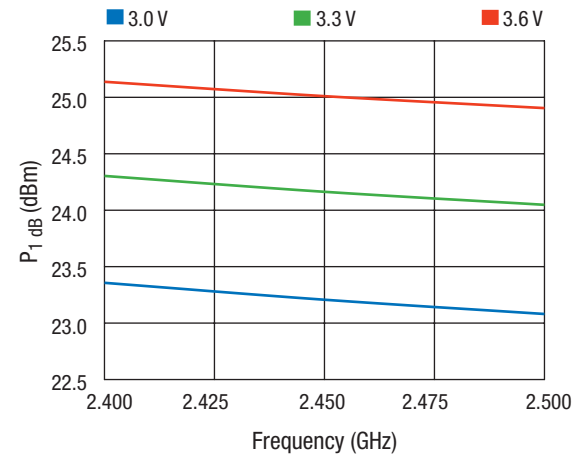

Output P₁ dB vs. Frequency Across V_{CC}

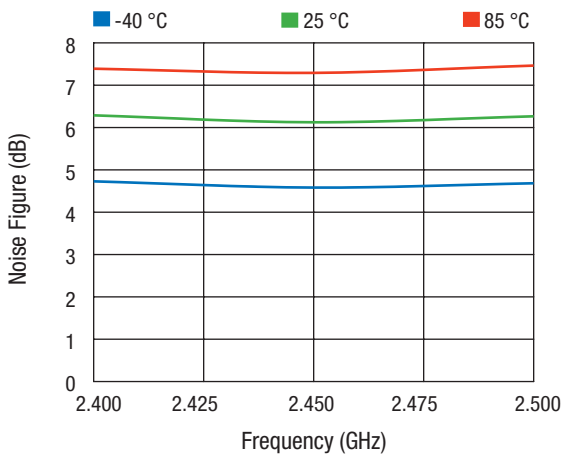

Noise Figure vs. Frequency Across Temperature

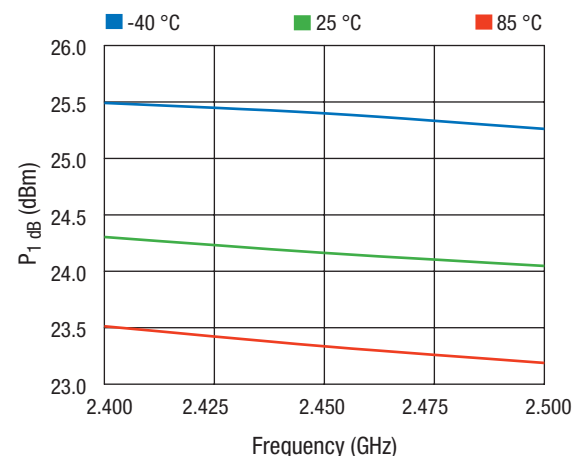

Output P₁ dB vs. Frequency Across Temperature

Typical Performance Data

$V_{CC} = V_{BCC} = 3.3\text{ V}$, $V_{REF} = V_{DCC} = 3\text{ V}$, $Z_0 = 50\ \Omega$, $T_C = 25\ ^\circ\text{C}$, Frequency = 2.442 GHz unless otherwise noted

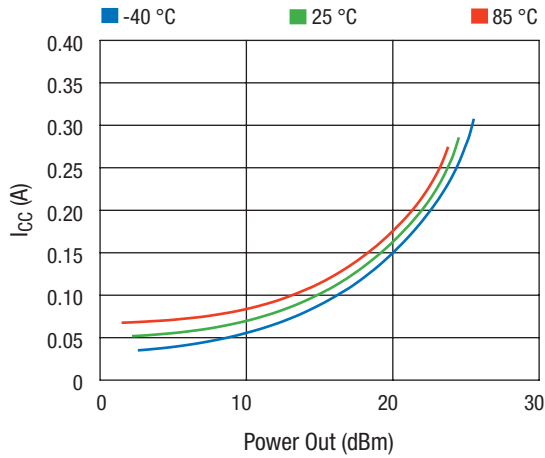

ICC vs. Power Out Across Temperature

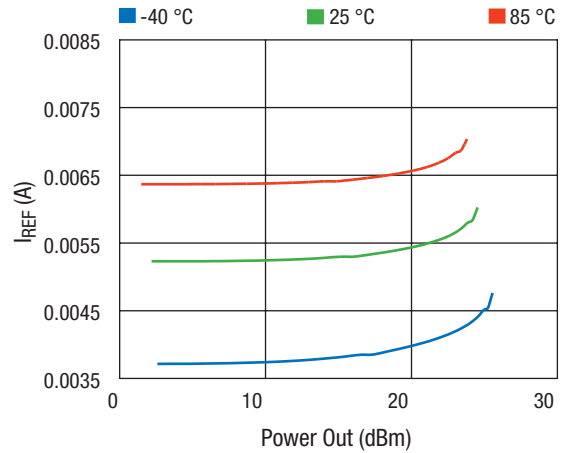

IREF vs. Power Out Across Temperature

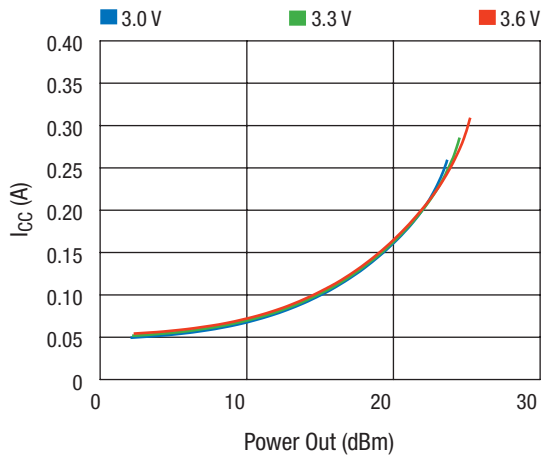

ICC vs. Power Out Across VCC

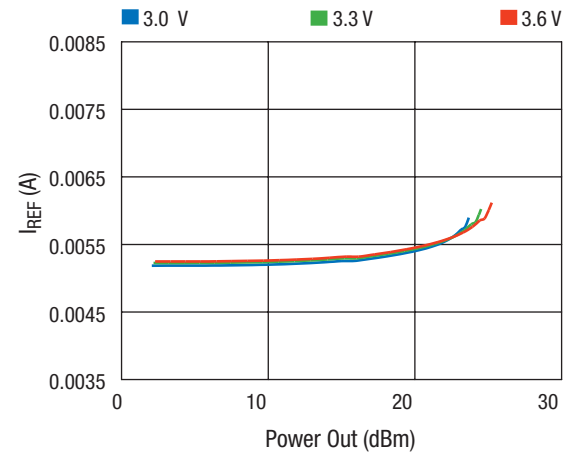

IREF vs. Power Out Across VCC

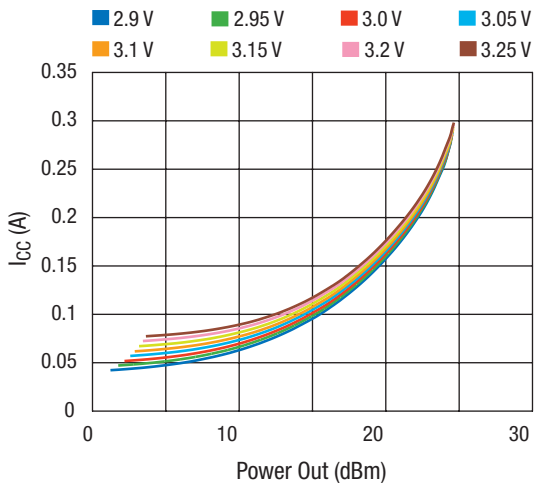

ICC vs. Power Out Across VREG

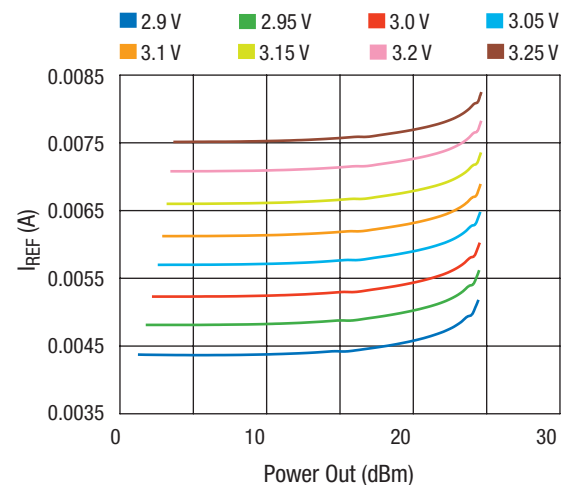

IREF vs. Power Out Across VREG

Typical Performance Data

$V_{CC} = V_{BCC} = 3.3\text{ V}$, $V_{REF} = V_{DCC} = 3\text{ V}$, $Z_0 = 50\ \Omega$, $T_C = 25\ ^\circ\text{C}$, Frequency = 2.442 GHz unless otherwise noted

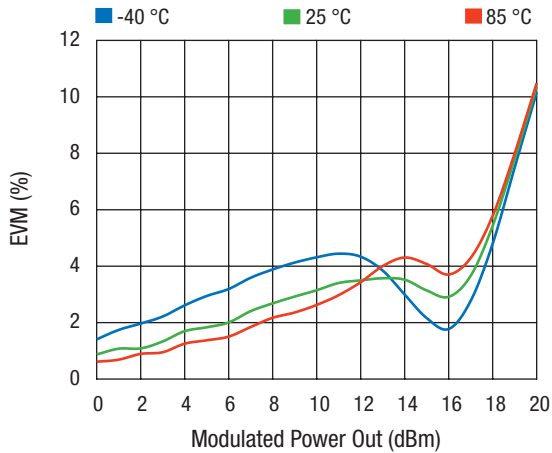

EVM vs. Modulated Power Out Across Temperature 802.11g, 54 Mbps, 64 QAM

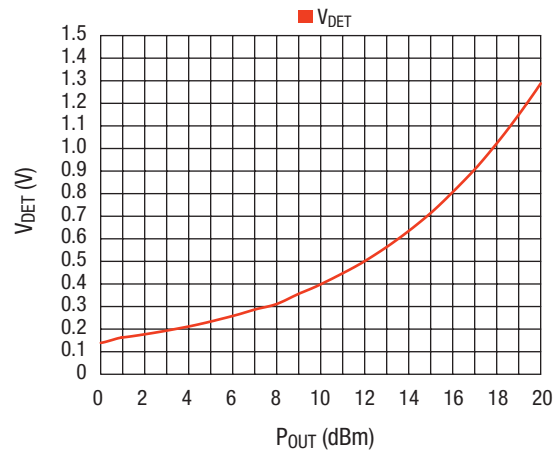

Detector Voltage vs. Power Out 802.11g, 54 Mbps, 64 QAM

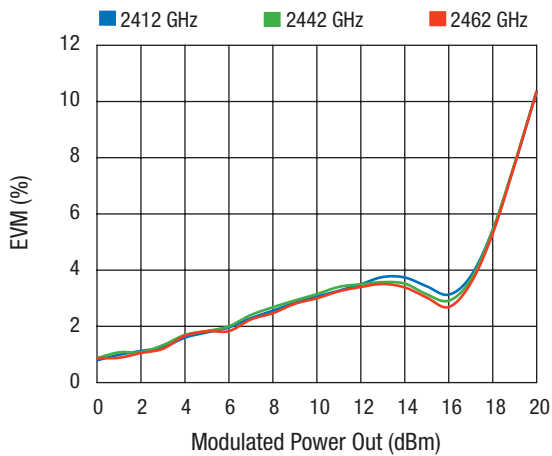

EVM vs. Modulated Power Out Across Frequency 802.11g, 54 Mbps, 64 QAM

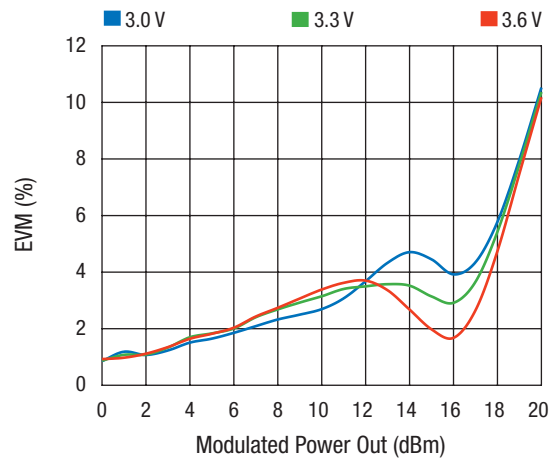

EVM vs. Modulated Power Out Across V_{CC} 802.11g, 54 Mbps, 64 QAM

Typical Performance Data

$V_{CC} = V_{BCC} = 3.3\text{ V}$, $V_{REF} = V_{DCC} = 3\text{ V}$, $Z_0 = 50\ \Omega$, $T_C = 25\ ^\circ\text{C}$, Frequency = 2.442 GHz unless otherwise noted

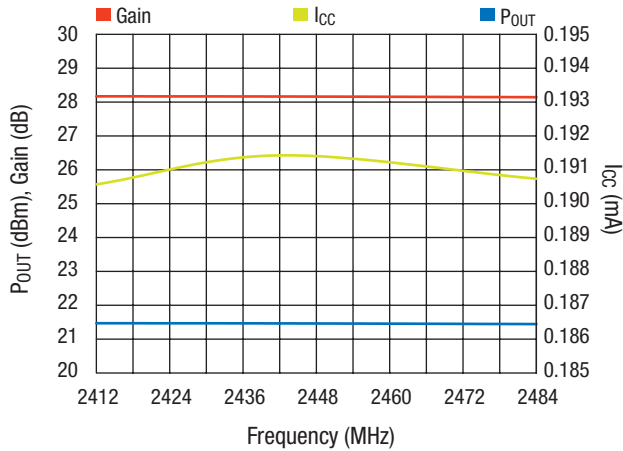

P_{OUT}, Gain, and I_{CC} vs. Frequency
802.11b, CCK, 11 Mbps

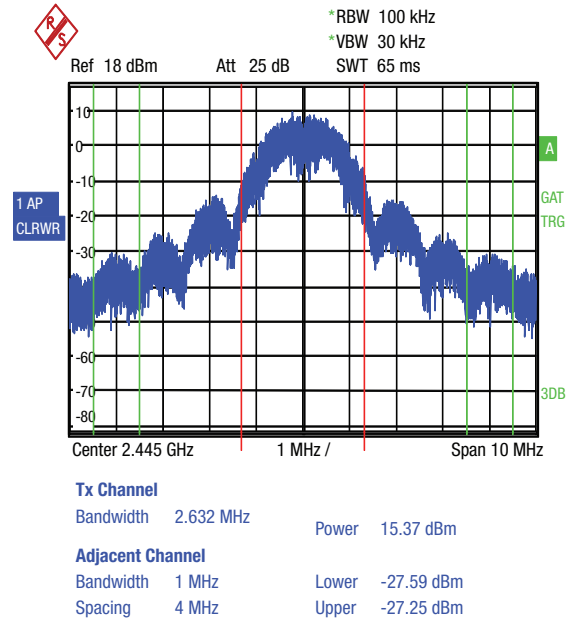

Applications Circuit

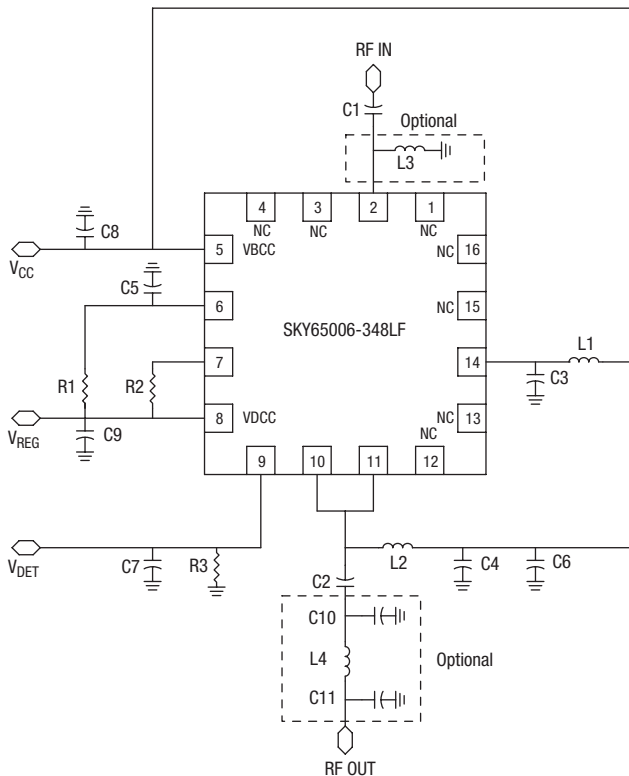

Zigbee® 802.15.4, Spectral Mask, O-QPSK, 250 Kb/s
F = 2.445 GHz, Channel Power = 15.4 dBm

Channel Absolute Power Spectral Density at Mask Limit (absolute limit of -30 dBm with $f-f_c > 3.5\text{ MHz}$ with 100 MHz resolution bandwidth).

Evaluation Board

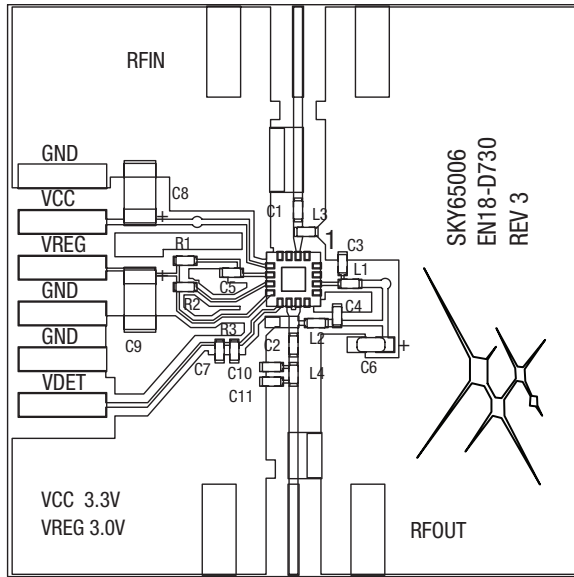

Board Layout

Bill of Material for Evaluation Board

Part #	ID	Size	Value	Units	Manufacturer	Product Number
1	C ₁	0402	5.6	pF	Murata	GRM1555C1H5R6CZ01E
2	C ₂	0402	5.6	pF	Murata	GRM1555C1H5R6CZ01E
3	C ₃	0402	10K	pF	Murata	GRM155R71E103KA01
4	C ₄	0402	10K	pF	Murata	GRM155R71E103KA01
5	C ₅	0402	1.8	pF	Murata	GRM1555C1H1R8CZ01D
6	C ₆	0603	4.7	μF	Panasonic	ECST1AZ475R
7	C ₇	0402	4.7	pF	Murata	GRM1555C1H4R7CZ01E
8	C ₈	1206	10	μF	AVX	TAJA106M006R
9	C ₉	1206	10	μF	AVX	TAJA106M006R
10	C ₁₀	0402	1	pF	Murata	GRM1555C1H1R0CZ01E
11	C ₁₁	0402	1	pF	Murata	GRM1555C1H1R0CZ01E
12	L ₁	0402	22	nH	TDK	MLK1005S22NJT000
13	L ₂	0402	22	nH	TDK	MLK1005S22NJT000
14	L ₃	0402	2.2	nH	TDK	MLK1005S2N2ST000
15	L ₄	0402	2.2	nH	TDK	MLK1005S2N2ST000
16	R ₁	0402	180	Ω	Panasonic	ERJ2GEJ181X
17	R ₂	0402	240	Ω	Panasonic	ERJ2GEJ241X
18	R ₃	0402	51K	Ω	Panasonic	ERJ2GEJ513X
19	PCB				Metro circuits	EN18-D730

Test Board Biasing Procedure

1. Connect the RF input and output ports as labeled on the engineering evaluation board.
2. Set the input power level from a CW signal generator to approximately -25 dBm.
3. Apply ground connection from DC voltage supply to all GND pins before applying any voltage.
4. Adjust the power supply to 3.3 V and set the current limit to 400 mA. Apply voltage to the pin labeled V_{CC} and note that there is no current draw from the supply. Be sure to apply the voltage to V_{CC} before applying any other voltages to the test board.
5. Adjust a second power supply output to 3.0 V and set the current limit to 30 mA. Apply voltage to the pin labeled V_{REG} and V_{DCC} . Note that the current draw for V_{REG} is approximately 10 mA.
6. Observe that the current on the V_{CC} supply is in the range of the quiescent current specification. The SKY65006 should be approximately 50 mA.
7. Observe that the small signal gain is within the range specified. The SKY65006 should be in the range of 27 dB. This should verify the proper working conditions for this device, and further testing can proceed.
8. To observe the detector voltage output, connect a voltmeter or oscilloscope to the V_{DET} pin on the evaluation test board. Set the signal source to CW mode and increase power until the output voltage begins to increase. The nominal offset voltage with low or no signal inputs should be approximately 50–200 mV and should increase monotonically to approximately 700–1000 mV, when driven at an output level of approximately 18 dBm. The evaluation circuit contains an external 51K Ω resistor and an equivalent capacitance of 10 pF to ground.
9. Bias the unit off by first removing the V_{REG} power supply and finally remove the connection to the V_{CC} power supply.

Application Information

The Skyworks SKY65006 is a high-performance 2-stage InGaP power amplifier designed for 2.4–2.5 GHz ISM, IEEE802.11b, 802.11g WLAN and Zigbee® band applications. The SKY65006 is a high-efficiency linear amplifier designed for single 3.3 V supply operation, requiring no input and output matching components for 50 Ω operation. This device also includes an internal power detector and integrated harmonic filter for reduced PC board component count. The integrated low pass filter is also highly effective in reducing harmonics at their source by localizing harmonic rejection to a tiny portion of the PA chip. This significantly reduces the risk of radiation from a high order filter design external to the amplifier. Filtering of harmonics in this way may eliminate the need for an external shield over the PA, and reduces overall cost. If additional suppression of harmonics is required, an external low pass filter can be added to the output of the amplifier. Optional shunt inductor, L3, is included on the applications board at the input of the amplifier to improve the return loss. The typical performance data shown includes these optional components.

The SKY65006 requires a nominal V_{CC} supply voltage of 3.3 V and a positive control voltage $V_{REG1, 2}$ providing bias for the first and second stage amplifiers. Nominal control voltage, V_{REG} , is 2.5–2.6 V resulting from the stack of two emitter-base junctions of about 1.3 V each for typical GaAs HBT device. To insure proper reference currents into $V_{REG1, 2}$, for normal operation of the RF stages, drop-in resistors could be used between $V_{REG1, 2}$ and a V_{REG} supply. Bias control would then be set in the range of 2.7–3.5 V allowing added flexibility for both the control voltage value and desired RF stage currents. If additional output power is required, V_{CC} can also be increased 4.0 V. Biasing of each stage consists of an external resistor of 180 Ω (R_1) and 240 Ω (R_2) for the recommended typical bias currents of 15 mA and 35 mA for stage 1 and 2 respectively. In most applications one end of each of the bias resistors is tied to the V_{REG} supply, so both amplifier stages are biased with a single common voltage. Capacitor C_5 , 1.8 pF, bypasses the V_{REG} stage 1 control bias pin and is used to improve RF rejection of the bias control lines.

Although there is no need for external matching when operating in a 50 Ω system, an input and output 6 pF decoupling capacitor is shown on the evaluation circuit. This capacitor is only mandatory on the RF output side of the device. The RF input is DC isolated and could be connected to driver circuits directly without the need for additional blocking capacitors. Capacitors of 5.6 pF were chosen because their self-resonant frequency would not add any unwanted disturbances in the 50 Ω transmission line path. The SKY65006 is unconditionally stable at any frequency and voltage setting as long as it is grounded correctly. It is extremely important to pay special attention to the RF grounding pad under the device. Ground pad vias and solder mask patterns are designed in such a way to ensure minimum parasitic inductance to the underlying ground and at each RF bypassing component. To ensure reliable soldering of the device paddle, it is highly recommended that filled vias with a minimal reliable diameter and filling the entire pattern be used. The filled-via technique would remove the possibility of solder migration down via holes, which can cause a large increase in inductance and possible instabilities.

Each amplifier stage is biased through a series choke and shunt capacitor combination which is completely integrated on chip to provide maximum RF isolation and harmonic radiation immunity. To avoid interferences from the low-frequency gain of the amplifier and to insure stability at low out of band frequencies, stage 1 amplifier is biased through inductor L_1 . It is also then shunted by a large value capacitance to ensure proper low-frequency bypassing of the amplifier. To avoid a shunting effect on the 50 Ω line, a high-impedance, self-resonating choke L_2 (in the range of 22–33 nH depending on vendor and size) and a large value bypass capacitor are used for biasing the output stage. Capacitor C_6 , 4.7 μF , on the V_{CC} line should be placed as close as possible to the biasing network supplying stage 2 or the output stage of the amplifier. Applications with the DC bias being generated strictly from a battery as the voltage source may not require this capacitor, or as large a value as specified in the applications circuit. However, in that case, a smaller ceramic capacitor of at least 0.1 μF should be used and also placed as close as possible to the biasing network supplying stage 2. Capacitor C_9 affects amplifier turn-on time. Reduce the value of C_9 to decrease turn-on time as long as bias stability is not compromised.

Note: Normal operation requires that V_{CC} including VBCC be applied before the application of the V_{REG} voltages biasing stage 1 and 2 bias currents. If V_{CC} and VBCC are not applied prior to the application of the V_{REG} biasing, voltage damage could occur from excessive base current draw through the collector junction of the bias transistor.

The SKY65006 also includes an on-board, compensated power detector providing a single-ended output voltage for measuring power over a wide dynamic range. The detector load and settling time constant are set external to the device. Nominal detector load is 51K Ω and 5 pF, yielding a settling time of approximately 500 ns. Note that there is an internal 5 pF on-chip capacitance, so the net capacitance value is approximately 10 pF. Lower resistor values may be used if necessary with the net impact being a lower output detector voltage over its useful dynamic range. For proper detector operation, a reference voltage must be applied to the V_{DET} line. Any voltage between 2 and 4 V is acceptable for the reference voltage, but it is recommended to supply V_{DET} from the V_{REG} power supply. The benefit in doing

this is that the approximate 2 mA of current that the reference circuit consumes will not be wasted with the PA in the “Off” state. There is also the option of not biasing the detector reference if the current consumption is of prime importance, but the detector will then act as a normal unbiased detector, and sensitivity and accuracy will be degraded.

The evaluation circuit board is constructed as a four-layer FR4 stack with an overall thickness of 0.062 inches (1.57 mm). Top layer dielectric is 0.01-inch thick with 50 Ω transmission line widths of 0.0195 inches. The printed circuit board is constructed using a symmetrical 0.01-inch stack on the top and bottom layers and with a 0.032-inch thick pre-preg core. All components are 0402 in size with the exception of the 4.7 μF and 10 μF tantalum capacitors. Please note the 10 μF capacitors are installed to provide low frequency filtering for lab testing. Actual values, if necessary, will be dependent upon layout and circuit environment. All ground vias used are 0.012 inches in diameter and placed as close to the ground ends of by-passing components as possible. Four vias are used under the device to create a low inductance path to ground. If a smaller diameter is to be used, or if the substrate thickness is greater than 0.01 inches, additional vias must be placed under the device to reduce the potential risk of parasitic oscillation.

Evaluation Board Stack-Up

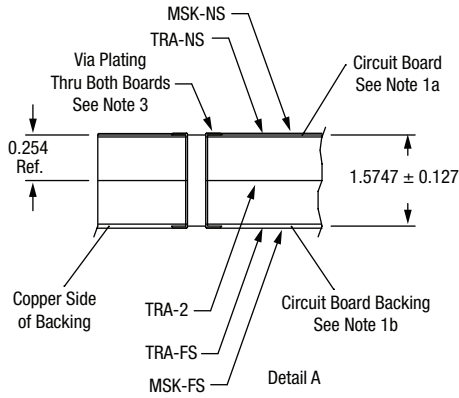

Notes:

- Units = mm.
- 1. Material:
 - 1a. Circuit board: FR4, 0.254 mm thick, 1 oz finished copper TRA-NS layer, 1/2 oz finished copper TRA-2 layer.
 - 1b. Circuit board backing: FR4 prepreg, 1 oz copper one side.
 - 1c. Laminate the unmetallized side of backing to bottom of circuit board for a total thickness of 1.5747 ± 0.127 mm. (See Detail A)
- 2. Plating: 200 microinches of nickel, and 50–100 microinches of soft gold.
- 3. Via plating: Cu plate 0.001 to 0.0015 thru both boards.
- 4. RF lines marked with * to be finished width of 0.50 mm measured at bottom of trace (trace to board interface).
 - All line width tolerances ± 0.025 mm.
 - All rubout tolerances ± 0.025 mm.
- 5. Silk-screen reference designators approximately as shown.
- 6. Separate boards with router.

Recommended Solder Reflow Profiles

Refer to the [“Recommended Solder Reflow Profile”](#) Application Note.

Tape and Reel Information

Refer to the [“Discrete Devices and IC Switch/Attenuators Tape and Reel Package Orientation”](#) Application Note.

Device Branding Specifications

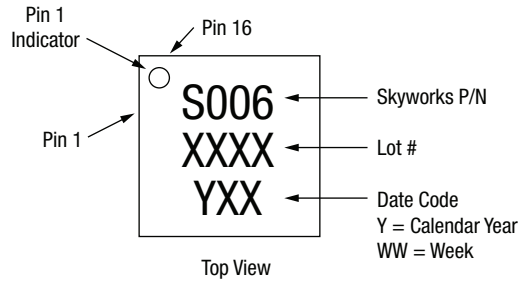

Package Footprint

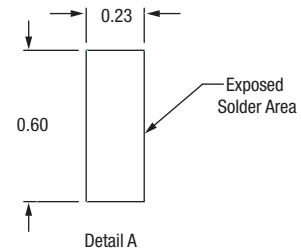
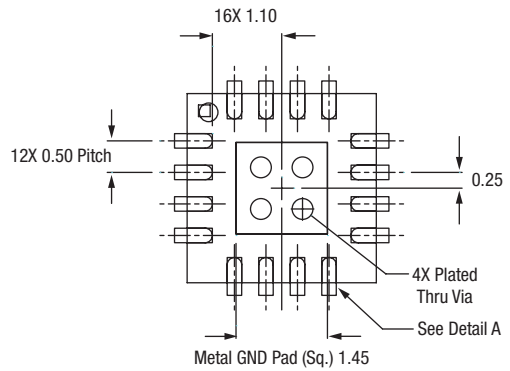

Units = mm

Ordering Information

Model Name	Manufacturing Part Number	Evaluation Kit Part Number
SKY65006-348LF: 2.4–2.5 GHz WLAN/Zigbee® Power Amplifier	SKY65006-348LF (Pb-free package)	TW17-D620-001

Copyright © 2002, 2003, 2004, 2005, 2006, 2007, 2008, Skyworks Solutions, Inc. All Rights Reserved.

Information in this document is provided in connection with Skyworks Solutions, Inc. (“Skyworks”) products or services. These materials, including the information contained herein, are provided by Skyworks as a service to its customers and may be used for informational purposes only by the customer. Skyworks assumes no responsibility for errors or omissions in these materials or the information contained herein. Skyworks may change its documentation, products, services, specifications or product descriptions at any time, without notice. Skyworks makes no commitment to update the materials or information and shall have no responsibility whatsoever for conflicts, incompatibilities, or other difficulties arising from any future changes.

No license, whether express, implied, by estoppel or otherwise, is granted to any intellectual property rights by this document. Skyworks assumes no liability for any materials, products or information provided hereunder, including the sale, distribution, reproduction or use of Skyworks products, information or materials, except as may be provided in Skyworks Terms and Conditions of Sale.

THE MATERIALS, PRODUCTS AND INFORMATION ARE PROVIDED “AS IS” WITHOUT WARRANTY OF ANY KIND, WHETHER EXPRESS, IMPLIED, STATUTORY, OR OTHERWISE, INCLUDING FITNESS FOR A PARTICULAR PURPOSE OR USE, MERCHANTABILITY, PERFORMANCE, QUALITY OR NON-INFRINGEMENT OF ANY INTELLECTUAL PROPERTY RIGHT; ALL SUCH WARRANTIES ARE HEREBY EXPRESSLY DISCLAIMED. SKYWORKS DOES NOT WARRANT THE ACCURACY OR COMPLETENESS OF THE INFORMATION, TEXT, GRAPHICS OR OTHER ITEMS CONTAINED WITHIN THESE MATERIALS. SKYWORKS SHALL NOT BE LIABLE FOR ANY DAMAGES, INCLUDING BUT NOT LIMITED TO ANY SPECIAL, INDIRECT, INCIDENTAL, STATUTORY, OR CONSEQUENTIAL DAMAGES, INCLUDING WITHOUT LIMITATION, LOST REVENUES OR LOST PROFITS THAT MAY RESULT FROM THE USE OF THE MATERIALS OR INFORMATION, WHETHER OR NOT THE RECIPIENT OF MATERIALS HAS BEEN ADVISED OF THE POSSIBILITY OF SUCH DAMAGE.

Skyworks products are not intended for use in medical, lifesaving or life-sustaining applications, or other equipment in which the failure of the Skyworks products could lead to personal injury, death, physical or environmental damage. Skyworks customers using or selling Skyworks products for use in such applications do so at their own risk and agree to fully indemnify Skyworks for any damages resulting from such improper use or sale.

Customers are responsible for their products and applications using Skyworks products, which may deviate from published specifications as a result of design defects, errors, or operation of products outside of published parameters or design specifications. Customers should include design and operating safeguards to minimize these and other risks. Skyworks assumes no liability for applications assistance, customer product design, or damage to any equipment resulting from the use of Skyworks products outside of stated published specifications or parameters.

Skyworks, the Skyworks symbol, and “Breakthrough Simplicity” are trademarks or registered trademarks of Skyworks Solutions, Inc., in the United States and other countries. Third-party brands and names are for identification purposes only, and are the property of their respective owners. Additional information, including relevant terms and conditions, posted at www.skyworksinc.com, are incorporated by reference.