

Small Signal Diode

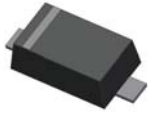

Features

- ✧ Wide zener voltage range selection : 2.4V to 56V
- ✧ Vz Tolerance Selection of ±5%
- ✧ Moisture sensitivity level 1
- ✧ Matte Tin(Sn) lead finish
- ✧ Pb free version and RoHS compliant
- ✧ Green compound (Halogen free) with suffix "G" on packing code and prefix "G" on date code

Mechanical Data

- ✧ Case : Flat lead SOD-123 small outline plastic package
- ✧ Terminal: Matte tin plated, lead free., solderable per MIL-STD-202, Method 208 guaranteed
- ✧ High temperature soldering guaranteed: 260 °C/10s
- ✧ Polarity : Indicated by cathode band
- ✧ Weight : 8.85±0.5 mg

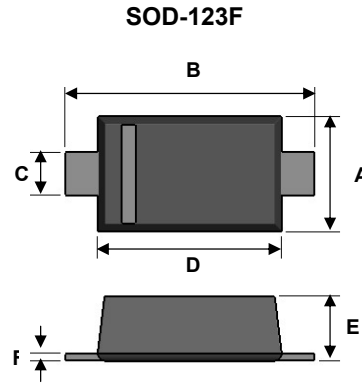

Dimensions	Unit (mm)		Unit (inch)	
	Min	Max	Min	Max
A	1.5	1.7	0.059	0.067
B	3.3	3.7	0.130	0.146
C	0.5	0.7	0.020	0.028
D	2.5	2.7	0.098	0.106
E	0.8	1.0	0.031	0.039
F	0.05	0.2	0.002	0.008

Ordering Information

Part No.	Package	Packing
MMSZ52xxB RH	SOD-123F	3Kpcs / 7" Reel

Maximum Ratings and Electrical Characteristics

Rating at 25°C ambient temperature unless otherwise specified.

Maximum Ratings

Type Number	Symbol	Value	Units
Power Dissipation	P_D	500	mW
Forward Voltage	V_F (I _F =10mA)	1	V
Thermal Resistance (Junction to Ambient)	R θ JA (Note 1)	330	°C/W
Junction and Storage Temperature Range	T _J , T _{STG}	-65 to + 150	°C

Notes:1. Valid provided that electrodes are kept at ambient temperature

Zener I vs. V Characteristics

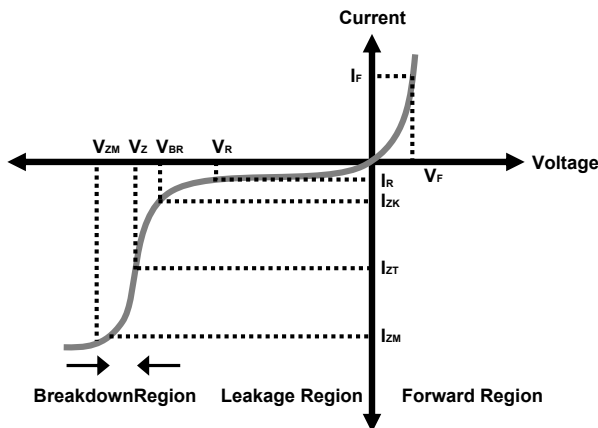

- V_{BR} : Voltage at I_{ZK}
- I_{ZK} : Test current for voltage V_{BR}
- Z_{ZK} : Dynamic impedance at I_{ZK}
- I_{ZT} : Test current for voltage V_Z
- V_Z : Voltage at current I_{ZT}
- Z_{ZT} : Dynamic impedance at I_{ZT}
- I_{ZM} : Maximum steady state current
- V_{ZM} : Voltage at I_{ZM}

Small Signal Diode
Electrical Characteristics

Ta = 25°C unless otherwise noted

V_F Forward Voltage = 1V Maximum @ I_F = 10 mA for all part numbers

Part Number	V _Z @ I _{ZT} (Volt)			I _{ZT} (mA)	Z _{ZT} @ I _{ZT} (Ω) Max	I _{ZK} (mA)	Z _{ZK} @ I _{ZK} (Ω) Max	I _R @ V _R (μA) Max	V _R (V)
	Nom	Min	Max						
MMSZ5221B	2.4	2.28	2.52	20	30	0.25	1200	100	1.0
MMSZ5222B	2.5	2.38	2.63	20	30	0.25	1250	100	1.0
MMSZ5223B	2.7	2.57	2.84	20	30	0.25	1300	75	1.0
MMSZ5224B	2.8	2.66	2.94	20	30	0.25	1400	75	1.0
MMSZ5225B	3.0	2.85	3.15	20	30	0.25	1600	50	1.0
MMSZ5226B	3.3	3.14	3.47	20	28	0.25	1600	25	1.0
MMSZ5227B	3.6	3.42	3.78	20	24	0.25	1700	15	1.0
MMSZ5228B	3.9	3.71	4.10	20	23	0.25	1900	10	1.0
MMSZ5229B	4.3	4.09	4.52	20	22	0.25	2000	5.0	1.0
MMSZ5230B	4.7	4.47	4.94	20	19	0.25	1900	5.0	2.0
MMSZ5231B	5.1	4.85	5.36	20	17	0.25	1600	5.0	2.0
MMSZ5232B	5.6	5.32	5.88	20	11	0.25	1600	5.0	3.0
MMSZ5233B	6.0	5.70	6.30	20	7	0.25	16900	5.0	3.5
MMSZ5234B	6.2	5.89	6.51	20	7	0.25	1000	5.0	4.0
MMSZ5235B	6.8	6.46	7.14	20	5	0.25	750	3.0	5.0
MMSZ5236B	7.5	7.13	7.88	20	6	0.25	500	3.0	6.0
MMSZ5237B	8.2	7.79	8.61	20	8	0.25	500	3.0	6.5
MMSZ5238B	8.7	8.27	9.14	20	8	0.25	600	3.0	6.5
MMSZ5239B	9.1	8.65	9.56	20	10	0.25	600	3.0	7.0
MMSZ5240B	10	9.50	10.50	20	17	0.25	600	3.0	8.0
MMSZ5241B	11	10.45	11.55	20	22	0.25	600	2.0	8.4
MMSZ5242B	12	11.40	12.60	20	30	0.25	600	1.0	9.1
MMSZ5243B	13	12.35	13.65	9.5	13	0.25	600	0.5	9.9
MMSZ5244B	14	13.30	14.70	9.0	15	0.25	600	0.1	10.0
MMSZ5245B	15	14.25	15.75	8.5	16	0.25	600	0.1	11
MMSZ5246B	16	15.20	16.80	7.8	17	0.25	600	0.1	12
MMSZ5247B	17	16.15	17.85	7.4	19	0.25	600	0.1	13
MMSZ5248B	18	17.10	18.90	7.0	21	0.25	600	0.1	14
MMSZ5249B	19	18.05	19.95	6.6	23	0.25	600	0.1	14
MMSZ5250B	20	19.00	21.00	6.2	25	0.25	600	0.1	15
MMSZ5251B	22	20.90	23.10	5.6	29	0.25	600	0.1	17
MMSZ5252B	24	22.80	25.20	5.2	33	0.25	600	0.1	18
MMSZ5253B	25	23.75	26.25	5.0	35	0.25	600	0.1	19
MMSZ5254B	27	25.65	28.35	5.0	41	0.25	600	0.1	21
MMSZ5255B	28	26.60	29.40	4.5	44	0.25	600	0.1	21
MMSZ5256B	30	28.50	31.50	4.2	49	0.25	600	0.1	23
MMSZ5257B	33	31.35	34.65	3.8	58	0.25	700	0.1	25
MMSZ5258B	36	34.20	37.80	3.4	70	0.25	700	0.1	27
MMSZ5259B	39	37.05	40.95	3.2	80	0.25	800	0.1	30
MMSZ5260B	43	40.85	45.15	3.0	93	0.25	900	0.1	33
MMSZ5261B	47	44.65	49.35	2.7	105	0.25	1000	0.1	36
MMSZ5262B	51	48.45	53.55	2.5	125	0.25	1100	0.1	39
MMSZ5263B	56	53.20	58.80	2.2	150	0.25	1300	0.1	43

Notes:

1. The Zener Voltage (V_Z) is tested under pulse condition of 1ms.
2. The device numbers listed have a standard tolerance on the nominal zener voltage of **±5%**.
3. For detailed information on price, availability and delivery of nominal zener voltages between the voltages shown and tighter voltage tolerances, contact your nearest **Taiwan semiconductor** representative.
4. The zener impedance is derived from the 60-cycle ac voltage, which results when an ac current having an rms value equal to 10% of the DC zener current (I_{ZT} or I_{ZK}) is superimposed to I_{ZT} or I_{ZK}.

Small Signal Diode

Rating and Sharacteristic Curves

FIG 1 Typical Forward Characteristics

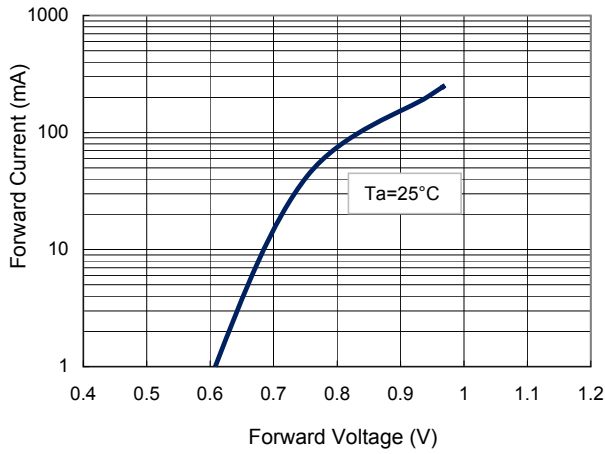

FIG 2 Zener Breakdown Characteristics

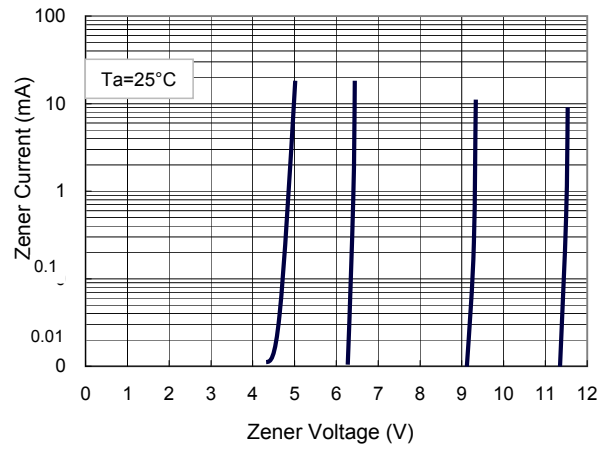

FIG 3 Zener Breakdown Characteristics

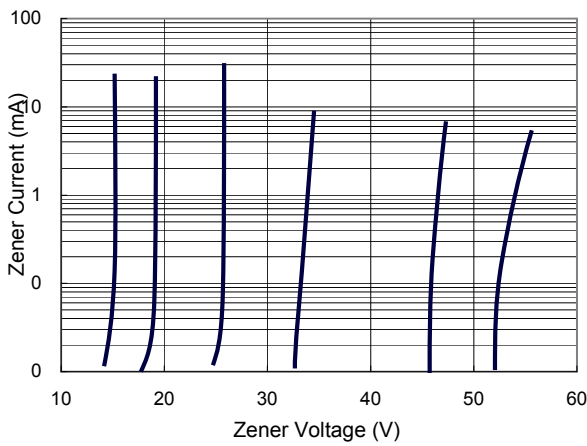

FIG 4 Admissible Power Dissipation Curve

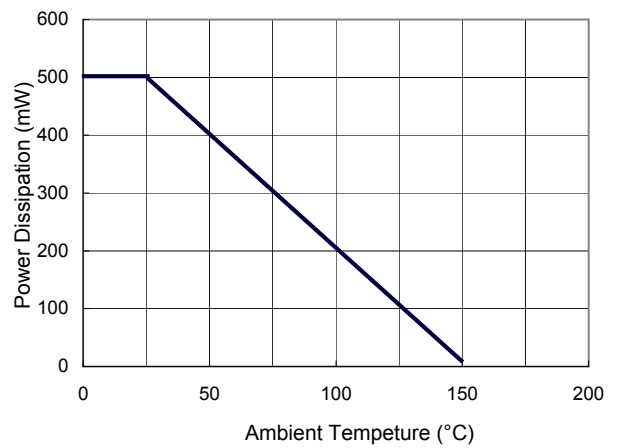

FIG 5 Typical Capacitance

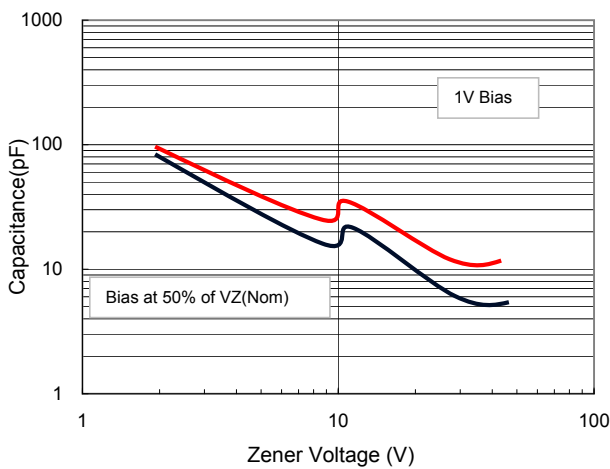

FIG 6 Effect of Zener Voltage on Impedance

