



# LITE-ON TECHNOLOGY CORPORATION

Property of Lite-On Only

## Features

- \* High Intensity.
- \* Popular T-1 3/4 diameter Package.
- \* Selected minimum intensities.
- \* Wide viewing Angle.
- \* General purpose leads.
- \* Reliable and rugged.

## Package Dimensions

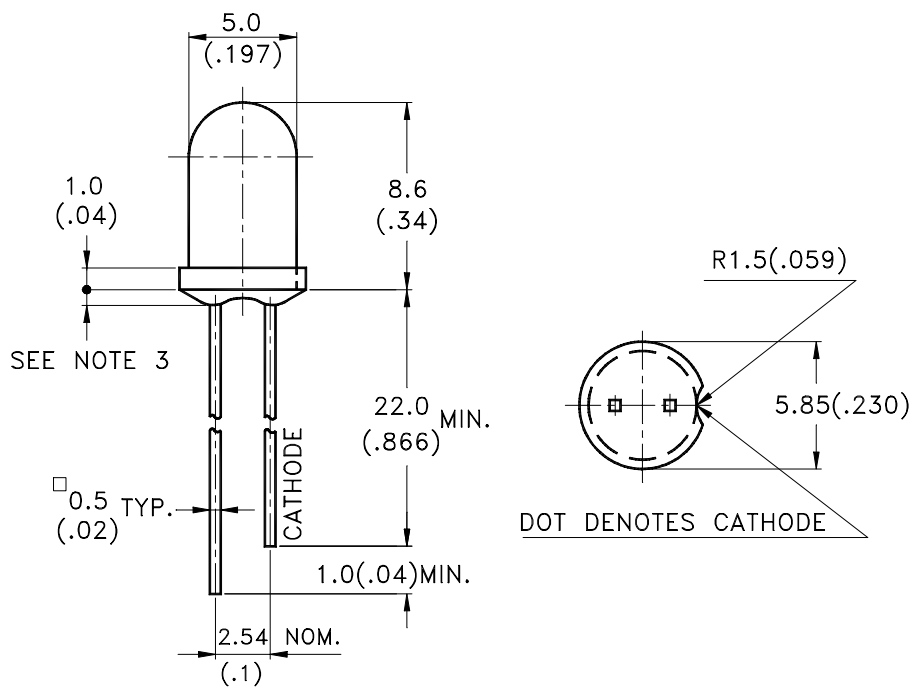

Part No.	Lens	Source Color
LTL-307E-051	Red Diffused	Hi-Eff.Red

### Notes:

1. All dimensions are in millimeters (inches).
2. Tolerance is  $\pm 0.25\text{mm}(.010\text{'})$  unless otherwise noted.
3. Protruded resin under flange is 1.0mm(.04") max.
4. Lead spacing is measured where the leads emerge from the package.
5. Specifications are subject to change without notice.



# LITE-ON TECHNOLOGY CORPORATION

Property of Lite-On Only

## Absolute Maximum Ratings at TA=25°C

Parameter	Maximum Rating	Unit
Power Dissipation	100	mW
Peak Forward Current (1/10 Duty Cycle, 0.1ms Pulse Width)	120	mA
Continuous Forward Current	30	mA
Derating Linear From 50°C	0.4	mA/°C
Reverse Voltage	5	V
Operating Temperature Range	-55°C to + 100°C	
Storage Temperature Range	-55°C to + 100°C	
Lead Soldering Temperature [1.6mm(.063") From Body]	260°C for 5 Seconds	



# LITE-ON TECHNOLOGY CORPORATION

Property of Lite-On Only

## Electrical / Optical Characteristics at TA=25°C

Parameter	Symbol	Min.	Typ.	Max.	Unit	Test Condition
Luminous Intensity	I <sub>v</sub>	5.6	19		mcd	I <sub>F</sub> = 10mA Note 1,4
Viewing Angle	2θ <sub>1/2</sub>		50		deg	Note 2 (Fig.6)
Peak Emission Wavelength	λ <sub>P</sub>		635		nm	Measurement @Peak (Fig.1)
Dominant Wavelength	λ <sub>d</sub>		623		nm	Note 3
Spectral Line Half-Width	Δλ		40		nm	
Forward Voltage	V <sub>F</sub>		2.0	2.6	V	I <sub>F</sub> = 20mA
Reverse Current	I <sub>R</sub>			100	μA	V <sub>R</sub> = 5V
Capacitance	C		20		pF	V <sub>F</sub> = 0, f = 1MHz

Note: 1. Luminous intensity is measured with a light sensor and filter combination that approximates the CIE (Commission International De L'Eclairage) eye-response curve.

2. θ<sub>1/2</sub> is the off-axis angle at which the luminous intensity is half the axial luminous intensity.

3. The dominant wavelength, λ<sub>d</sub> is derived from the CIE chromaticity diagram and represents the single wavelength which defines the color of the device.

4. The I<sub>v</sub> guarantee should be added ±15% .

### Typical Electrical / Optical Characteristics Curves

(25°C Ambient Temperature Unless Otherwise Noted)

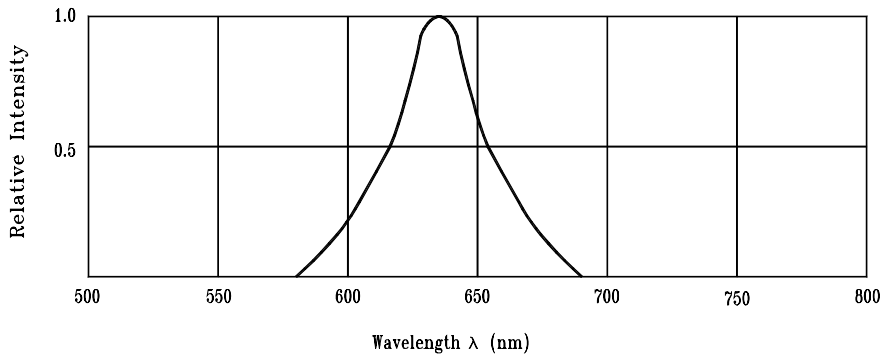

Fig.1 Relative Intensity vs. Wavelength

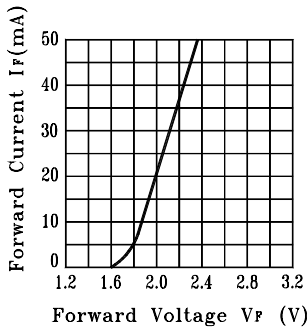

Fig.2 Forward Current vs. Forward Voltage

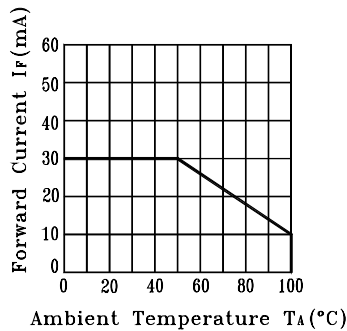

Fig.3 Forward Current Derating Curve

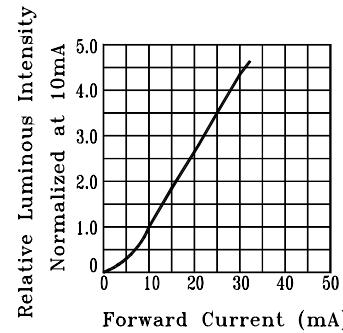

Fig.4 Relative Luminous Intensity vs. Forward Current

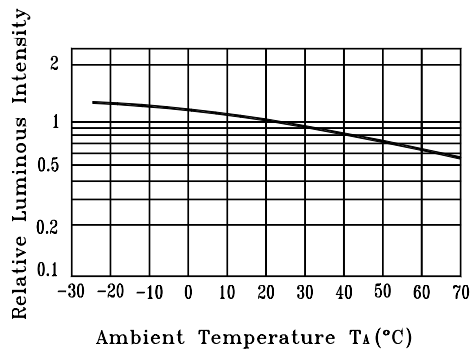

Fig.5 Luminous Intensity vs. Ambient Temperature

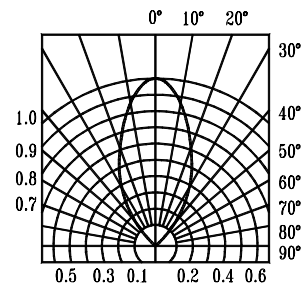
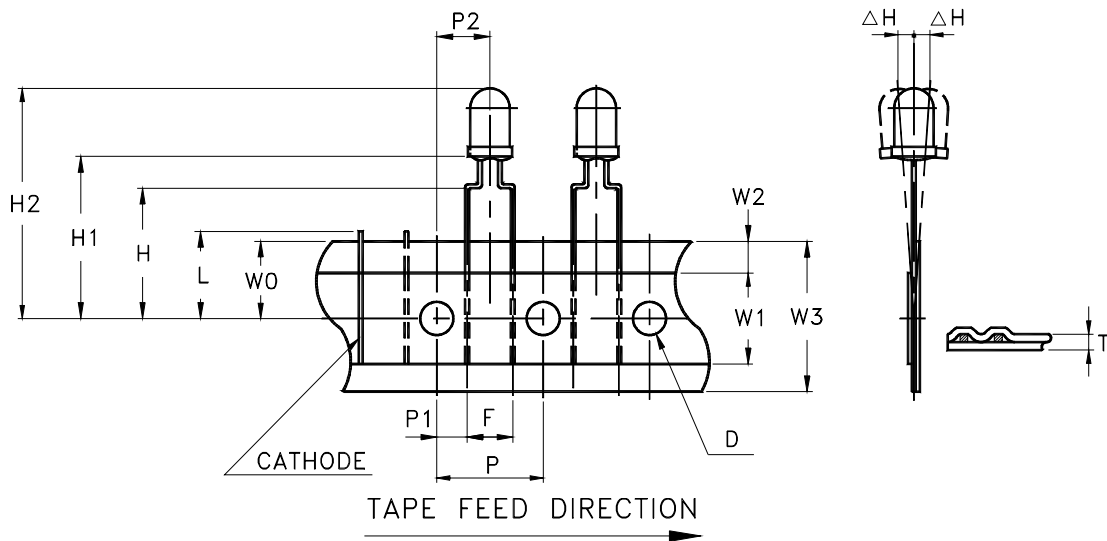

Fig.6 Spatial Distribution

### Features

- \* Compatible with radial lead automatic insertion equipment.
- \* Most radial lead plastic lead lamps available packaged in tape and reel.
- \* 5mm (0.197") formed lead spacing available.
- \* Reel packaging simplifies handling and testing.

### Package Dimensions



Item	Symbol	Specification			
		Minimum		Maximum	
		mm	inch	mm	inch
Tape Feed Hole Diameter	D	3.8	0.149	4.2	0.165
Component Lead Pitch	F	4.8	0.188	5.8	0.228
Front to Rear Deflection	$\Delta H$	--	--	2.0	0.078
Height of Seating Plane	H	15.5	0.610	16.5	0.649
Feed Hole to Bottom of Component	H1	20.8	0.818	22.8	0.898
Feed Hole to Overall Component Height	H2	29.2	1.149	31.7	1.247
Lead Length After Component Height	L	W0		11.0	0.433
Feed Hole Pitch	P	12.4	0.488	13.0	0.511
Lead Location	P1	3.15	0.124	4.55	0.179
Center of Component Location	P2	5.05	0.198	7.65	0.301
Total Tape Thickness	T	--	--	0.90	0.035
Feed Hole Location	W0	8.5	0.334	9.75	0.384
Adhesive Tape Width	W1	14.5	0.571	15.5	0.610
Adhesive Tape Position	W2	0	0	3.0	0.118
Tape Width	W3	17.5	0.689	19.0	0.748

## CAUTIONS

### 1. Application limitation

The LEDs described here are intended to be used for ordinary electronic equipment (such as office equipment, communication equipment and household application.) Consult Liteon's sales in advance for information on application in which exceptional quality and reliability are required, particularly when the failure or malfunction of the LEDs may directly jeopardize life or health (such as airplanes, automobiles, traffic control equipment, life support system and safety devices).

### 2. Storage

After being shipped from Liteon the LEDs should be kept at 30°C or less and 70%RH or less.

The LEDs should be used within 3 months. They can be stored for a year in a sealed container with a nitrogen atmosphere and moisture absorbent material. Please avoid rapid transitions in ambient temperature in high humidity environments where condensation may occur.

### 3. Cleaning

Use alcohol-based cleaning solvents such as isopropyl alcohol to clean the LED.

### 4. Forming & Mounting

When forming a lead, the leads should be bent at a point at least 3mm from the base of epoxy bulb. Do not use the base of the leadframe as a fulcrum during forming. Lead forming must be done before soldering at normal temperature. When mounted through hole type LED lamp, avoid the occurrence of residual mechanical stress due to clinching.

### 5. Soldering

When soldering, leave a minimum of 2mm clearance from the resin to the soldering point.

Dipping the resin into the solder must be avoided.

Do not apply any stress to the lead frame during soldering while the LED is at high temperature.

Recommended soldering condition

Soldering iron		Wave soldering	
Temperature	300°C Max.	Pre-heat	100°C Max.
Soldering time	3 sec. Max. (one time only)	Pre-heat time	60 sec. Max.
		Solder wave	260°C Max.
		Soldering time	10 sec. Max.

### 6. Drive Method

LED is a current operated device, and therefore, requires some kind of current limiting incorporated into the drive circuit. This current limiting typically takes the form of a current limiter resistor placed in series with the LED. Consider worst case voltage variations that could occur across the current limiting resistor.

The forward current should not be allowed to change by more than 40% of its desired value.

**Circuit model A**

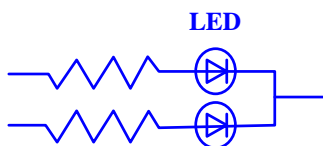

**Circuit model B**

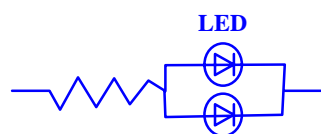

(A) Recommended circuit.

(B) The difference of brightness between LEDs could be found due to the  $V_f$ - $I_f$  characteristics of LED



# LITE-ON TECHNOLOGY CORPORATION

Property of Lite-On Only

## 7. ESD (Electrostatic Discharge)

Static Electricity or power surge will damage the LED. Use of a conductive wrist band or anti- electrostatic glove is recommended when handling these LED. All devices, equipment and machinery must be properly grounded.

## 8. Reliability Test

Classification	Test Item	Test Condition	Duration / Cycle	Reference Standard
Endurance Test	Room Temp. Operation Life	Ta= Room Temp, Ip= 160 mA / 1/8 duty, Pulse Width =1.25 ms	1000 hrs	MIL-STD-750D:1026 (1995) MIL-STD-883D:1005 (1991) JIS C 7021:B-1 (1982)
Environmental Test	Temperature Cycling	105°C ~ 25°C ~ -55°C ~ 25°C 30mins 5mins 30mins 5mins	10 cycles	MIL-STD-202F:107D (1980) MIL-STD-750D:1051(1995) MIL-STD-883D:1010 (1991) JIS C 7021: A-4(1982)
	Solder Resistance	Solder temperature is 260± 5 °C	10 sec	MIL-STD-202F:210A(1980) MIL-STD-750D:2031(1995) JIS C 7021: A-1(1982)
	Solderability	Solder temperature is 230± 5 °C	5 sec	MIL-STD-202F:208D(1980) MIL-STD-750D:2026(1995) MIL-STD-883D:2003(1991) JIS C 7021: A-2(1982)

## 9. Others

The appearance and specifications of the product may be modified for improvement without notice.