

## FEATURES

- Eighteen 20mA Universal Current Sources with 64-Step Linear Brightness Control
- Independent On/Off, Brightness Level, Blinking and Gradation Control for Each Current Source Using 2-Wire I<sup>2</sup>C Interface
- Low Noise Multi-Mode Charge Pump (1x, 1.5x, 2x) Provides Up to 91% Efficiency
- Slew Limited Switching Reduces Conducted and Radiated Noise (EMI)
- Up to 360mA Total Output Current
- Internal Current Reference
- Single Reset Pin for Asynchronous Shutdown and Reset of All Data Registers
- Two I<sup>2</sup>C Addresses Are Available (LTC3220: 0011100, LTC3220-1: 0011101)
- Automatic or Forced Mode Switching
- Internal Soft-Start Limits Inrush Current
- Short-Circuit/Thermal Protection
- 4mm × 4mm Ultrathin (0.55mm) 28-Lead QFN Package

## APPLICATIONS

- Video Phones with QVGA+ Displays
- Keypad Lighting
- General/Miscellaneous Lighting

## DESCRIPTION

The LTC3220/LTC3220-1 are highly integrated multi-display LED drivers. These parts contain a high efficiency, low noise charge pump to provide power to up to eighteen universal LED current sources. The LTC3220/LTC3220-1 require only five small ceramic capacitors to form a complete LED power supply and current controller.

The LED currents are set by an internal precision current reference. Independent dimming, on/off, blinking and gradation control for all universal current sources is achieved via the I<sup>2</sup>C serial interface. 6-bit linear DACs are available to adjust brightness levels independently for each universal LED current source.

The LTC3220/LTC3220-1 charge pump optimizes efficiency based on the voltage across the LED current sources. The part powers up in 1x mode and will automatically switch to boost mode whenever any enabled LED current source begins to enter dropout. The first dropout switches the parts into 1.5x mode and a subsequent dropout switches the LTC3220/LTC3220-1 into 2x mode. The parts reset to 1x mode whenever a data bit is updated via the I<sup>2</sup>C port.

LT, LT, LTC and LTM are registered trademarks of Linear Technology Corporation. All other trademarks are the property of their respective owners. Protected by U.S. Patents including 6411531.

## TYPICAL APPLICATION

6-LED Main, 4 RGB LEDs

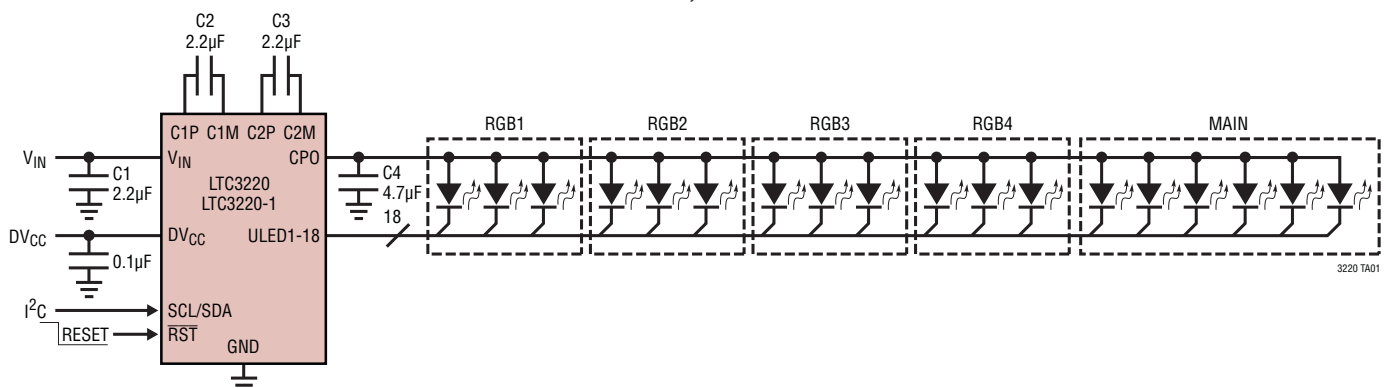

# LTC3220/LTC3220-1

## ABSOLUTE MAXIMUM RATINGS

(Notes 1, 4)

|                                         |                               |
|-----------------------------------------|-------------------------------|
| $V_{IN}$ , $DV_{CC}$ , CPO to GND ..... | -0.3V to 6V                   |
| ULED1-ULED18 to GND .....               | -0.3V to 6V                   |
| SDA, SCL, $\overline{RST}$ .....        | -0.3V to ( $DV_{CC} + 0.3V$ ) |
| $I_{CPO}$ (Continuous) (Note 2) .....   | 360mA                         |
| $I_{ULED1-18}$ (Note 2) .....           | 25mA                          |
| CPO Short-Circuit Duration .....        | Indefinite                    |
| Operating Temperature Range (Note 3)    |                               |
| LTC3220E/LTC3220E-1 .....               | -40°C to 85°C                 |
| LTC3220I/LTC3220I-1 .....               | -40°C to 125°C                |
| Storage Temperature Range .....         | -65°C to 150°C                |

## PIN CONFIGURATION

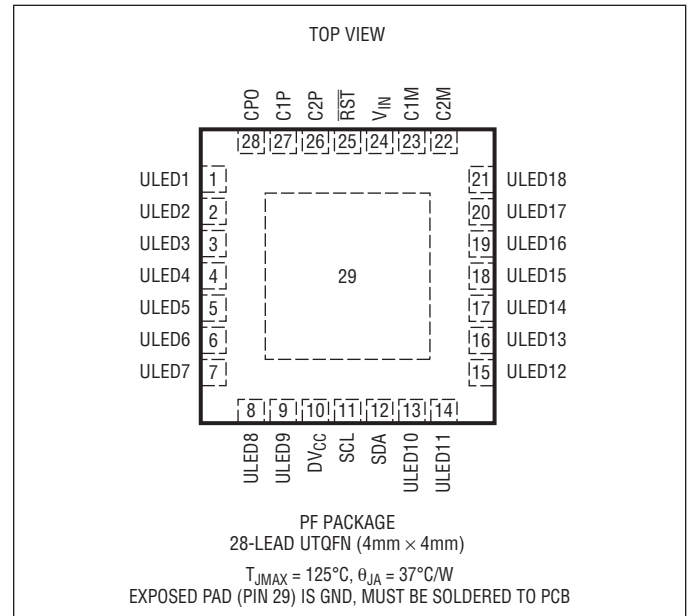

## ORDER INFORMATION

| LEAD FREE FINISH | TAPE AND REEL      | PART MARKING* | PACKAGE DESCRIPTION       | TEMPERATURE RANGE |
|------------------|--------------------|---------------|---------------------------|-------------------|
| LTC3220EPF#PBF   | LTC3220EPF#TRPBF   | 3220T         | 28-Lead UTQFN (4mm × 4mm) | -40°C to 85°C     |
| LTC3220EPF-1#PBF | LTC3220EPF-1#TRPBF | 2201T         | 28-Lead UTQFN (4mm × 4mm) | -40°C to 85°C     |
| LTC3220IPF#PBF   | LTC3220IPF#TRPBF   | 3220T         | 28-Lead UTQFN (4mm × 4mm) | -40°C to 125°C    |
| LTC3220IPF-1#PBF | LTC3220IPF-1#TRPBF | 2201T         | 28-Lead UTQFN (4mm × 4mm) | -40°C to 125°C    |

Consult LTC Marketing for parts specified with wider operating temperature ranges. \*The temperature grade is identified by a label on the shipping container. Consult LTC Marketing for information on non-standard lead based finish parts.

For more information on lead free part marking, go to: <http://www.linear.com/leadfree/>

For more information on tape and reel specifications, go to: <http://www.linear.com/tapeandreel/>

## ELECTRICAL CHARACTERISTICS

The ● denotes the specifications which apply over the full operating temperature range, otherwise specifications are at  $T_A = 25^{\circ}C$ .  $V_{IN} = 3.6V$ ,  $DV_{CC} = 3V$ ,  $\overline{RST} = \text{high}$ ,  $C1 = C2 = C3 = 2.2\mu F$ ,  $C4 = 4.7\mu F$ , unless otherwise noted.

| SYMBOL | PARAMETER                   | CONDITIONS                | MIN | TYP | MAX | UNITS   |
|--------|-----------------------------|---------------------------|-----|-----|-----|---------|
|        | $V_{IN}$ Operating Voltage  |                           | ●   | 2.9 | 5.5 | V       |
|        | $I_{VIN}$ Operating Current | $I_{CPO} = 0$ , 1x Mode   |     | 580 |     | $\mu A$ |
|        |                             | $I_{CPO} = 0$ , 1.5x Mode |     | 2.4 |     | mA      |
|        |                             | $I_{CPO} = 0$ , 2x Mode   |     | 3.2 |     | mA      |
|        | $DV_{CC}$ UVLO Threshold    |                           |     | 1   |     | V       |
|        | $DV_{CC}$ Operating Voltage |                           | ●   | 1.5 | 5.5 | V       |
|        | $V_{IN}$ UVLO Threshold     |                           |     | 1.5 |     | V       |

32201fb

**ELECTRICAL CHARACTERISTICS** The ● denotes the specifications which apply over the full operating temperature range, otherwise specifications are at  $T_A = 25^\circ\text{C}$ .  $V_{IN} = 3.6\text{V}$ ,  $DV_{CC} = 3\text{V}$ ,  $RST = \text{high}$ ,  $C1 = C2 = C3 = 2.2\mu\text{F}$ ,  $C4 = 4.7\mu\text{F}$ , unless otherwise noted.

| SYMBOL                                                     | PARAMETER                                      | CONDITIONS                                                             | MIN | TYP                 | MAX                 | UNITS         |                   |
|------------------------------------------------------------|------------------------------------------------|------------------------------------------------------------------------|-----|---------------------|---------------------|---------------|-------------------|
|                                                            | $V_{IN}$ Shutdown Current                      |                                                                        | ●   | 3.2                 | 7                   | $\mu\text{A}$ |                   |
|                                                            | $DV_{CC}$ Shutdown Current                     |                                                                        | ●   |                     | 1                   | $\mu\text{A}$ |                   |
| <b>Universal LED Current, 6-Bit Linear DACs, ULED = 1V</b> |                                                |                                                                        |     |                     |                     |               |                   |
|                                                            | Full-Scale LED Current                         |                                                                        | ●   | 18                  | 20                  | 22            | $\text{mA}$       |
|                                                            | Minimum ( $I_{LSB}$ ) LED Current Step         |                                                                        |     | 0.314               |                     |               | $\text{mA}$       |
|                                                            | Minimum Programmable Current                   | ULED Data Register Programmed to 0b00000001                            |     | 0.395               |                     |               | $\text{mA}$       |
|                                                            | LED Current Matching                           | Any Two Outputs, 50% of FS                                             |     | 1.5                 |                     |               | %                 |
|                                                            | LED Dropout Voltage                            | $I_{LED} = \text{FS}$                                                  |     | 120                 |                     |               | $\text{mV}$       |
|                                                            | Blink Rate Period                              | REG19, D3 and D4                                                       |     | 1.25                | 2.5                 |               | Sec<br>Sec        |
|                                                            | ULED Up/Down Gradation Ramp Times              | REG19, D1 and D2                                                       |     | 0.24                | 0.48                | 0.96          | Sec<br>Sec<br>Sec |
|                                                            | Gradation Period                               | REG19, D1 and D2                                                       |     | 0.313               | 0.625               | 0.410         | Sec<br>Sec<br>Sec |
|                                                            | $V_{OL}$ General Purpose Output Mode (GPO)     | $I_{OUT} = 1\text{mA}$ , Single Output Enabled                         |     | 5                   |                     |               | $\text{mV}$       |
|                                                            | LED Turn-On Delay                              | From Stop Bit, Part Enabled                                            |     | 4                   |                     |               | $\mu\text{s}$     |
| <b>Charge Pump (CPO)</b>                                   |                                                |                                                                        |     |                     |                     |               |                   |
|                                                            | 1x Mode Output Impedance                       |                                                                        |     | 0.6                 |                     |               | $\Omega$          |
|                                                            | 1.5x Mode Output Impedance                     | $V_{IN} = 3\text{V}$ , $V_{CPO} = 4.2\text{V}$ (Note 5)                |     | 3.6                 |                     |               | $\Omega$          |
|                                                            | 2x Mode Output Impedance                       | $V_{IN} = 3\text{V}$ , $V_{CPO} = 4.8\text{V}$ (Note 5)                |     | 4.1                 |                     |               | $\Omega$          |
|                                                            | CPO Regulation Voltage                         | 1.5x Mode, $I_{CPO} = 20\text{mA}$<br>2x Mode, $I_{CPO} = 20\text{mA}$ |     | 4.5                 | 5.03                |               | V<br>V            |
|                                                            | Clock Frequency                                |                                                                        | ●   | 0.65                | 0.85                | 1.05          | $\text{MHz}$      |
| <b>CPO Short-Circuit Detection</b>                         |                                                |                                                                        |     |                     |                     |               |                   |
|                                                            | Threshold Voltage                              |                                                                        | ●   | 0.4                 |                     | 1.3           | V                 |
|                                                            | Test Current                                   | CPO = 0V                                                               | ●   | 10                  |                     | 30            | $\text{mA}$       |
| <b>SDA, SCL, RST</b>                                       |                                                |                                                                        |     |                     |                     |               |                   |
| $V_{IL}$                                                   |                                                |                                                                        | ●   |                     | $0.3 \cdot DV_{CC}$ |               | V                 |
| $V_{IH}$                                                   |                                                |                                                                        | ●   | $0.7 \cdot DV_{CC}$ |                     |               | V                 |
| $I_{IH}$                                                   |                                                | SDA, SCL, $\overline{RST} = DV_{CC}$                                   | ●   | -1                  |                     | 1             | $\mu\text{A}$     |
| $I_{IL}$                                                   |                                                | SDA, SCL, $\overline{RST} = 0\text{V}$                                 | ●   | -1                  |                     | 1             | $\mu\text{A}$     |
| $V_{OL}$                                                   | Digital Output Low (SDA)                       | $I_{PULLUP} = 3\text{mA}$                                              | ●   |                     | 0.12                | 0.4           | V                 |
| RST Timing                                                 | Reset Pulse Duration                           |                                                                        |     | 10                  |                     |               | ns                |
| <b>Serial Port Timing (Notes 6, 7)</b>                     |                                                |                                                                        |     |                     |                     |               |                   |
| $f_{SCL}$                                                  | Clock Operating Frequency                      |                                                                        |     |                     | 400                 |               | $\text{kHz}$      |
| $t_{BUF}$                                                  | Bus Free Time Between Stop and Start Condition |                                                                        |     | 1.3                 |                     |               | $\mu\text{s}$     |
| $t_{HD,STA}$                                               | Hold Time After (Repeated) Start Condition     |                                                                        |     | 0.6                 |                     |               | $\mu\text{s}$     |
| $t_{SU,STA}$                                               | Repeated Start Condition Setup Time            |                                                                        |     | 0.6                 |                     |               | $\mu\text{s}$     |
| $t_{SU,STO}$                                               | Stop Condition Setup Time                      |                                                                        |     | 0.6                 |                     |               | $\mu\text{s}$     |

# LTC3220/LTC3220-1

**ELECTRICAL CHARACTERISTICS** The ● denotes the specifications which apply over the full operating temperature range, otherwise specifications are at  $T_A = 25^\circ\text{C}$ .  $V_{IN} = 3.6\text{V}$ ,  $DV_{CC} = 3\text{V}$ ,  $R_{ST} = \text{high}$ ,  $C_1 = C_2 = C_3 = 2.2\mu\text{F}$ ,  $C_4 = 4.7\mu\text{F}$ , unless otherwise noted.

| SYMBOL            | PARAMETER              | CONDITIONS | MIN | TYP | MAX | UNITS         |
|-------------------|------------------------|------------|-----|-----|-----|---------------|
| $t_{HD,DAT(OUT)}$ | Data Hold Time         |            | 0   |     | 900 | ns            |
| $t_{HD,DAT(IN)}$  | Input Data Hold Time   |            | 0   |     |     | ns            |
| $t_{SU,DAT}$      | Data Setup Time        |            | 100 |     |     | ns            |
| $t_{LOW}$         | Clock Low Period       |            | 1.3 |     |     | $\mu\text{s}$ |
| $t_{HIGH}$        | Clock High Period      |            | 0.6 |     |     | $\mu\text{s}$ |
| $t_f$             | Clock Data Fall Time   |            | 20  |     | 300 | ns            |
| $t_r$             | Clock Data Rise Time   |            | 20  |     | 300 | ns            |
| $t_{SP}$          | Spike Suppression Time |            |     |     | 50  | ns            |

**Note 1:** Stresses beyond those listed under Absolute Maximum Ratings may cause permanent damage to the device. Exposure to any Absolute Maximum Rating condition for extended periods may affect device reliability and lifetime.

**Note 2:** Based on long term current density limitations.

**Note 3:** The LTC3220E/LTC3220E-1 are guaranteed to meet performance specifications from  $0^\circ\text{C}$  to  $85^\circ\text{C}$ . Specifications over the  $-40^\circ\text{C}$  to  $85^\circ\text{C}$  operating temperature range are assured by design, characterization and correlation with statistical process controls. The LTC3220I/LTC3220I-1 are guaranteed to meet performance specifications over the full  $-40^\circ\text{C}$  to  $125^\circ\text{C}$  operating temperature range.

**Note 4:** These devices include overtemperature protection that is intended to protect the devices during momentary overload conditions. Junction temperatures will exceed  $125^\circ\text{C}$  when overtemperature protection is active. Continuous operation above the specified maximum operating junction temperature may result in device degradation or failure.

**Note 5:** 1.5x mode output impedance is defined as  $(1.5V_{IN} - V_{CPO})/I_{OUT}$ . 2x mode output impedance is defined as  $(2V_{IN} - V_{CPO})/I_{OUT}$ .

**Note 6:** All values are referenced to  $V_{IH}$  and  $V_{IL}$  levels.

**Note 7:** Guaranteed by design.

## TYPICAL PERFORMANCE CHARACTERISTICS $T_A = 25^\circ\text{C}$ unless otherwise noted.

Mode Switch Dropout Times

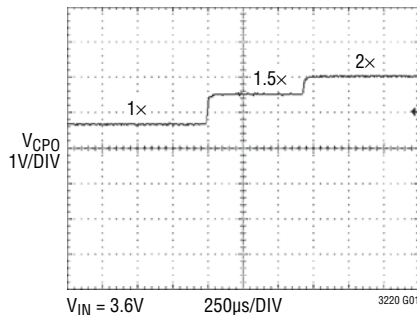

1.5x Mode CPO Ripple

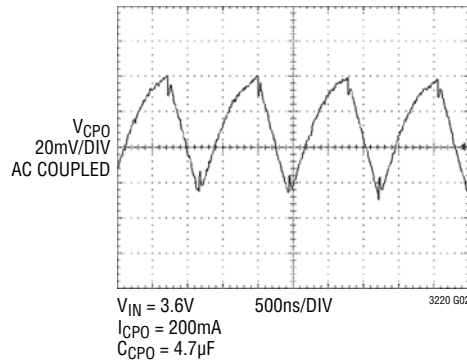

2x Mode CPO Ripple

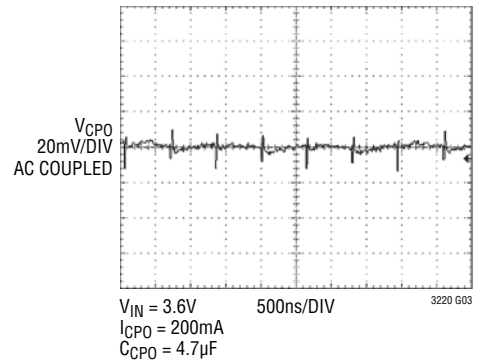

**TYPICAL PERFORMANCE CHARACTERISTICS**  $T_A = 25^\circ\text{C}$  unless otherwise noted.

**1x Mode Switch Resistance vs Temperature**

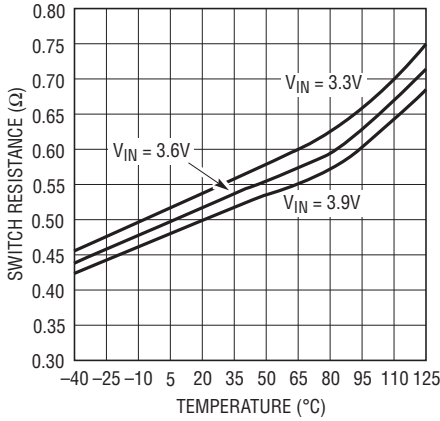

**1.5x Mode Charge Pump Open-Loop Output Resistance vs Temperature**

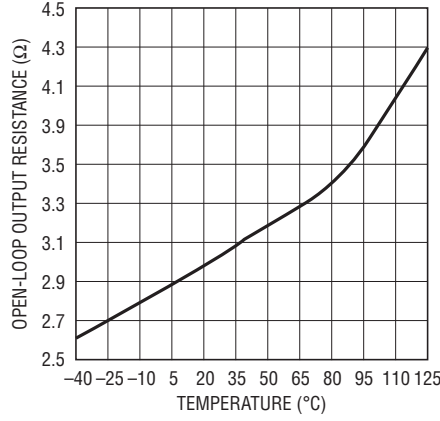

**1.5x Mode CPO Voltage vs ICPO**

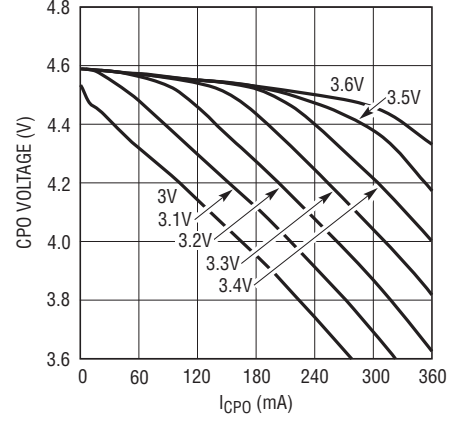

**2x Mode Charge Pump Open-Loop Output Resistance vs Temperature**

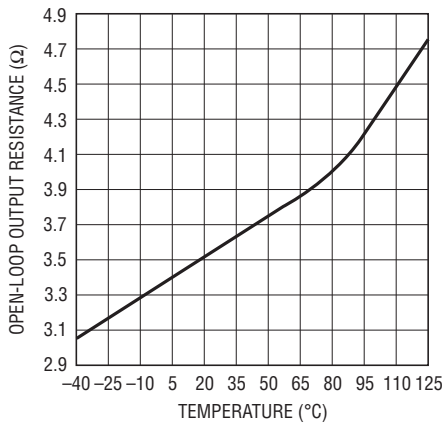

**2x Mode CPO Voltage vs ICPO**

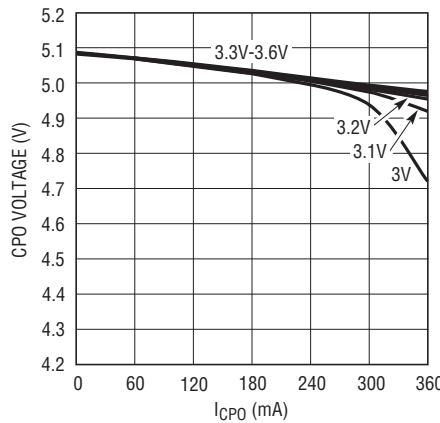

**Oscillator Frequency vs VIN Voltage**

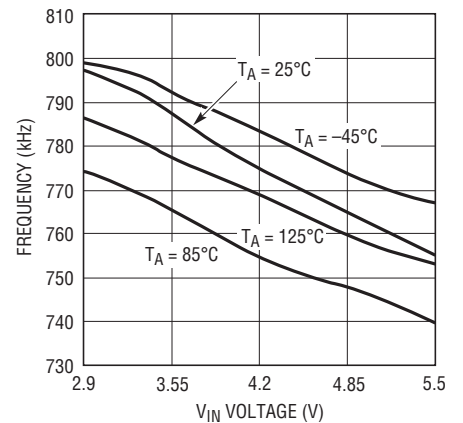

**VIN Shutdown Current vs VIN Voltage**

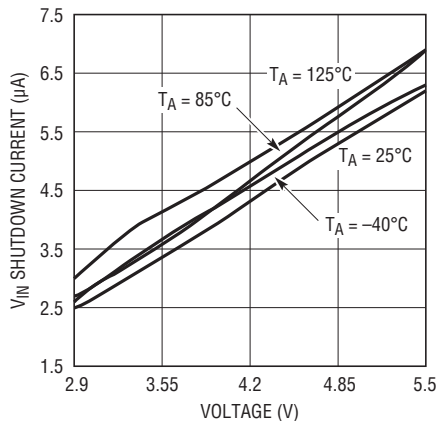

**DVCC Current vs DVCC Voltage**

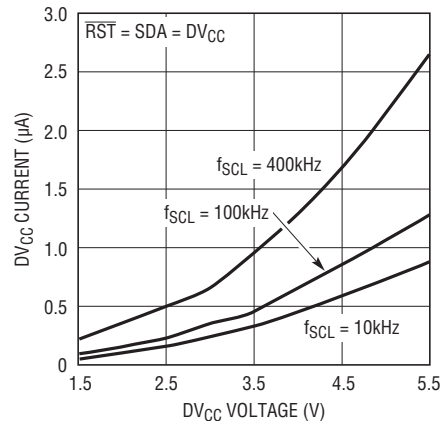

**1x Mode No Load VIN Current vs VIN Voltage**

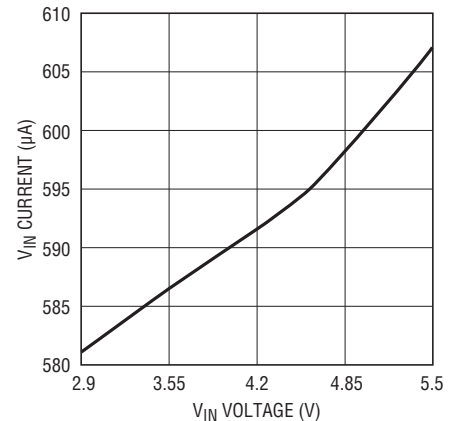

## TYPICAL PERFORMANCE CHARACTERISTICS $T_A = 25^\circ\text{C}$ unless otherwise noted.

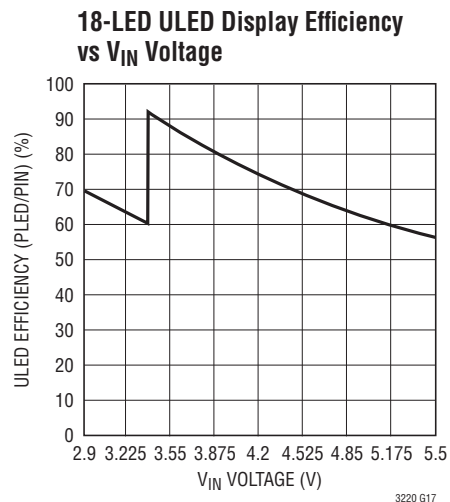
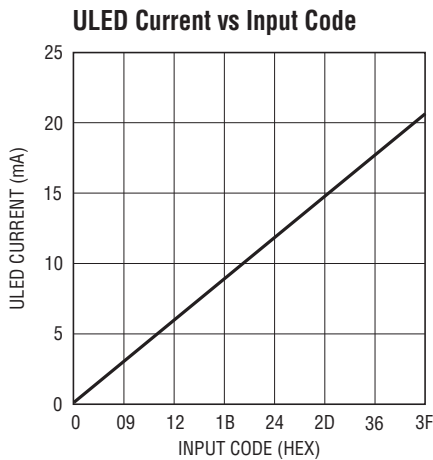
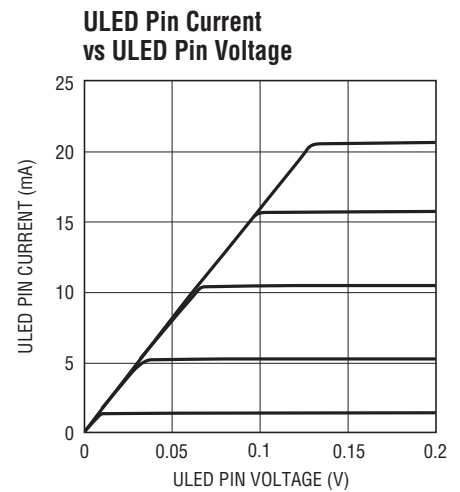
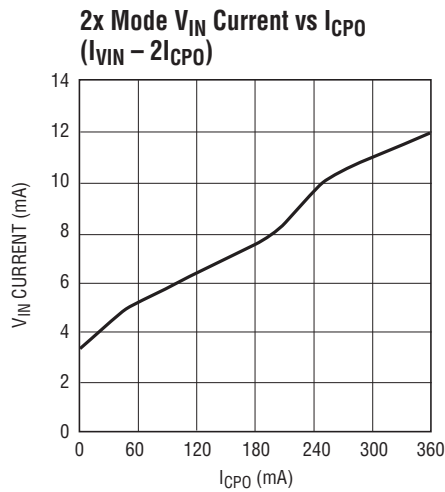
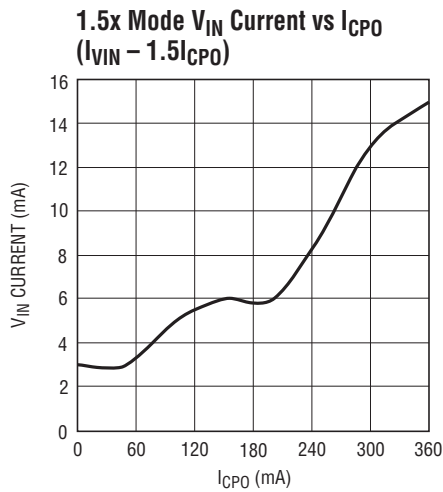

## PIN FUNCTIONS

**ULED1-ULED18 (Pins 1-9, 13-21):** Current Source Outputs for Driving LEDs. The LED current can be set from 0mA to 20mA in 64 steps via software control and internal 6-bit linear DAC. Each output can be disabled by setting the associated data register REG1 to REG18 low. ULED1 to ULED18 can also be used as I<sup>2</sup>C controlled open-drain general purpose outputs. Connect unused outputs to ground.

**DV<sub>CC</sub> (Pin 10):** Supply Voltage for All digital I/O lines. This pin sets the logic reference level of the LTC3220/LTC3220-1. DV<sub>CC</sub> will reset the data registers when set below the undervoltage lockout threshold. A 0.1 $\mu$ F X5R or X7R ceramic capacitor should be connected to ground.

**SCL (Pin 11):** I<sup>2</sup>C Clock Input. The logic level for SCL is referenced to DV<sub>CC</sub>.

## PIN FUNCTIONS

**SDA (Pin 12):** Input Data for the Serial Port. Serial data is shifted in one bit per clock cycle to control the LTC3220/LTC3220-1. The logic level is referenced to  $DV_{CC}$ .

**C1P, C2P, C1M, C2M (Pins 27, 26, 23, 22):** Charge Pump Flying Capacitor Pins. A  $2.2\mu\text{F}$  X7R or X5R ceramic capacitor should be connected from C1P to C1M and C2P to C2M.

**$V_{IN}$  (Pin 24):** Supply Voltage for the Entire Device. This pin must be bypassed with a single  $2.2\mu\text{F}$  low ESR ceramic capacitor.

**$\overline{\text{RST}}$  (Pin 25):** Active Low Reset Input.  $\overline{\text{RST}}$  Resets all internal registers and forces LTC3220/LTC3220-1 into shutdown mode.

**CPO (Pin 28):** Output of the Charge Pump. Used to power all LEDs. A  $4.7\mu\text{F}$  X5R or X7R ceramic capacitor should be connected to ground.

**Exposed Pad (Pin 29):** Ground. The Exposed Pad must be soldered to PCB ground.

## BLOCK DIAGRAM

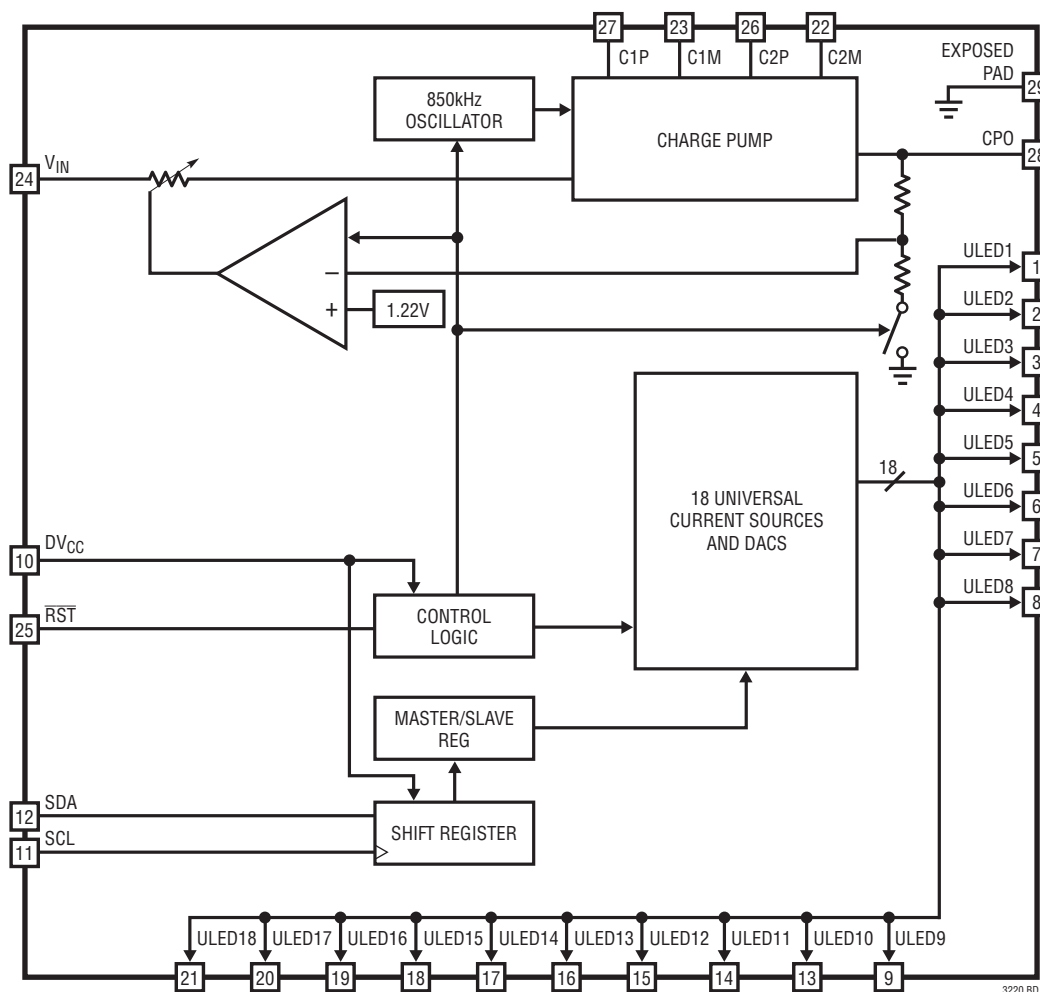

## OPERATION

### Power Management

The LTC3220/LTC3220-1 use a switched capacitor charge pump to boost CPO as much as 2 times the input voltage up to 5.1V. The part starts up in 1x mode. In this mode,  $V_{IN}$  is connected directly to CPO. This mode provides maximum efficiency and minimum noise. The LTC3220/LTC3220-1 will remain in 1x mode until an LED current source drops out. Dropout occurs when a current source voltage becomes too low for the programmed current to be supplied. When dropout is detected, the LTC3220/LTC3220-1 will switch into 1.5x mode. The CPO voltage will then start to increase and will attempt to reach  $1.5 \times V_{IN}$  up to 4.6V. Any subsequent dropout will cause the part to enter the 2x mode. The CPO voltage will attempt to reach  $2 \times V_{IN}$  up to 5.1V.

A 2-phase non-overlapping clock activates the charge pump switches. In the 2x mode the flying capacitors are charged on alternate clock phases from  $V_{IN}$  to minimize CPO voltage ripple. In 1.5x mode the flying capacitors are charged in series during the first clock phase and stacked in parallel on  $V_{IN}$  during the second phase. This sequence of charging and discharging the flying capacitors continues at a constant frequency of 850kHz.

The current delivered by each LED current source is controlled by an associated DAC. Each DAC is programmed via the I<sup>2</sup>C port.

### Soft-Start

Initially, when the part is in shutdown, a weak switch connects  $V_{IN}$  to CPO. This allows  $V_{IN}$  to slowly charge the CPO output capacitor and prevent large charging currents from occurring.

The LTC3220/LTC3220-1 also employ a soft-start feature on the charge pump to prevent excessive inrush current and supply droop when switching into the step-up modes. The current available to the CPO pin is increased linearly over a typical period of 125 $\mu$ s. Soft-start occurs at the start of both 1.5x and 2x mode changes.

### Charge Pump Strength

When the LTC3220/LTC3220-1 operate in either 1.5x mode or 2x mode, the charge pump can be modeled as a Thevenin-equivalent circuit to determine the amount of current available from the effective input voltage and effective open-loop output resistance,  $R_{OL}$  (Figure 1).

$R_{OL}$  is dependent on a number of factors including the switching term,  $1/(2f_{OSC} \cdot C_{FLY})$ , internal switch resistances and the non-overlap period of the switching circuit. However, for a given  $R_{OL}$ , the amount of current available will be directly proportional to the advantage voltage of  $1.5V_{IN} - CPO$  for 1.5x mode and  $2V_{IN} - CPO$  for 2x mode. Consider the example of driving LEDs from a 3.1V supply.

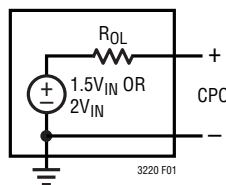

Figure 1. Charge Pump Open-Loop Thevenin Equivalent Circuit



## OPERATION

If the LED forward voltage is 3.8V and the current sources require 100mV, the advantage voltage for 1.5x mode is  $3.1V \cdot 1.5 - 3.8V - 0.1V$  or 750mV. Notice that if the input voltage is raised to 3.2V, the advantage voltage jumps to 900mV, a 20% improvement in available strength.

From Figure 1, for 1.5x mode the available current is given by:

$$I_{OUT} = \frac{1.5V_{IN} - V_{CPO}}{R_{OL}} \quad (1)$$

For 2x mode, the available current is given by:

$$I_{OUT} = \frac{2V_{IN} - V_{CPO}}{R_{OL}} \quad (2)$$

Notice that the advantage voltage in this case is  $3.1V \cdot 2 - 3.8V - 0.1V = 2.3V$ .  $R_{OL}$  is higher in 2x mode but a significant overall increase in available current is achieved.

### Mode Switching

The LTC3220/LTC3220-1 will automatically switch from 1x mode to 1.5x mode and subsequently to 2x mode whenever a dropout condition is detected at an LED pin. Dropout occurs when a current source voltage becomes too low for the programmed current to be supplied. The mode change will not occur unless dropout exists for approximately 400 $\mu$ s.

The mode will automatically switch back to 1x whenever a register is updated via the I<sup>2</sup>C port, when gradation completes ramping down and after each blink period.

The parts can be forced to operate in 1x, 1.5x or 2x mode by writing the appropriate bits into REG0. This feature may be used for operating loads powered by CPO.

Non-programmed current sources do not affect dropout.

### Universal Current Sources (ULED1 to ULED18)

There are eighteen universal 20mA current sources. Each current source has a 6-bit linear DAC for current control. The output current range is 0mA to 20mA in 64 steps.

Each current source is disabled when an all zero data word is written. The supply current for that source is reduced to zero. Unused outputs should be connected to GND.

### GPO Mode

ULED1 to ULED18 can be used as general purpose outputs (GPO). Current sources in the GPO mode can be used as I<sup>2</sup>C controlled open-drain drivers. A ULED output can be selected to operate in GPO mode by programming both Bit 6 and Bit 7 of its data register (REG1 to REG18) to a logic high. In the GPO mode, dropout detection is disabled and output swings to ground will not cause mode switching.

The GPOs can be programmed to either act as a switch (strong pull-down mode) in which the part will only consume approximately 3 $\mu$ A of quiescent current, or they can be programmed to have a regulated current of up to 20mA (current limit mode), which would require several hundred microamps of additional quiescent current.

When a ULED output is used in GPO mode during shutdown, CPO should not be used as a power source since the current available from the CPO pin would be limited by the weak pull-up current source. This weak pull-up is only meant to keep the output capacitor charged to  $V_{IN}$  during shutdown and is unable to supply large amounts of current. CPO can, however, be used as a power source when the part is enabled.

Conversely, when a ULED output is used in GPO strong pull-down mode, a current limiting resistor should be used in series with the ULED output so that the current does not exceed the Absolute Maximum rated current.

## OPERATION

### Blinking

Each universal output (ULED1 to ULED18) can be set to blink with an on time of 0.156 seconds, or 0.625 seconds and a period of 1.25 seconds, or 2.5 seconds via the I<sup>2</sup>C port. The blinking rate is selected via REG19 and ULED outputs are selected via REG1 to REG18. Blinking and gradation rates are independent. Please refer to Application Note 115 for detailed information and examples on programming blinking.

### Gradation

Universal LED outputs ULED1 to ULED18 can be set to have the current ramp up and down at 0.24 seconds, 0.48 seconds and 0.96 seconds rates via the I<sup>2</sup>C port. Each of these outputs can have either blinking or gradation enabled. The gradation time is set via REG19 and ULED outputs are selected via REG1 to REG18. The ramp direction is also controlled via REG19. Setting the up bit high causes gradation to ramp up, setting this bit to a low causes gradation to ramp down. Please refer to Application Note 115 for detailed information and examples on programming gradation.

When gradation is disabled the LED output current remains at the programmed value.

The charge pump mode is reset to 1x mode after gradation completes ramping down.

### Chip Reset ( $\overline{\text{RST}}$ )

The  $\overline{\text{RST}}$  pin is used to turn off the chip, including the charge pump and all ULED outputs, and clear all registers in the

LTC3220/LTC3220-1. When  $\overline{\text{RST}}$  is low, the part is in shutdown and cannot be programmed through the I<sup>2</sup>C port.

### Shutdown Current

Shutdown occurs when all the current source data bits have been written to zero, when the shutdown bit in REG0 is written with a logic 1, when  $\overline{\text{RST}}$  is pulled low, or when DV<sub>CC</sub> is set below the undervoltage lockout voltage.

Although the LTC3220/LTC3220-1 are designed to have very low shutdown current, they will draw about 3 $\mu$ A from V<sub>IN</sub> when in shutdown. Internal logic ensures that the LTC3220/LTC3220-1 are in shutdown when DV<sub>CC</sub> is low. Note, however that all of the logic signals that are referenced to DV<sub>CC</sub> (SCL, SDA and  $\overline{\text{RST}}$ ) will need to be at DV<sub>CC</sub> or below (i.e., ground) to avoid violation of the absolute maximum specifications on these pins.

### EMI Reduction

The flying capacitor pins C1M, C1P, C2M and C2P have controlled slew rates to reduce conducted and radiated noise.

### Serial Port

The microcontroller compatible I<sup>2</sup>C serial port provides all of the command and control inputs for the LTC3220/LTC3220-1. Data on the SDA input is loaded on the rising edge of SCL. D7 is loaded first and D0 last. There are 20 data registers, one address register and one sub-address register. Once all address bits have been clocked into the address register, an acknowledge occurs. The

## OPERATION

sub-address register is then written to, followed by the data register. Each data register has a sub-address. After the data register has been written a load pulse is created after the stop bit. The load pulse transfers all of the data held in the data registers to the DAC registers. The stop bit can be delayed until all of the data master registers have been written. At this point the LED current will be changed to the new settings. The serial port uses static logic registers so there is no minimum speed at which it can be operated.

### I<sup>2</sup>C Interface

The LTC3220/LTC3220-1 communicate with a host (master) using the standard I<sup>2</sup>C 2-wire interface. The Timing Diagram (Figure 3) shows the timing relationship of the signals on the bus. The two bus lines, SDA and SCL, must be high

when the bus is not in use. External pull-up resistors or current sources, such as the LTC1694 SMBus accelerator, are required on these lines.

The LTC3220/LTC3220-1 are receive-only (slave) devices.

There are two I<sup>2</sup>C addresses available. The LTC3220 I<sup>2</sup>C address is 0011100 and the LTC3220-1 I<sup>2</sup>C address is 0011101. The I<sup>2</sup>C address is the only difference between the LTC3220 and LTC3220-1.

### Write Word Protocol Used By the LTC3220/LTC3220-1

|   |               |    |   |              |   |           |   |     |
|---|---------------|----|---|--------------|---|-----------|---|-----|
| 1 | 7             | 1  | 1 | 8            | 1 | 8         | 1 | 1   |
| S | Slave Address | Wr | A | *Sub-Address | A | Data Byte | A | P** |

S = Start Condition, Wr = Write Bit = 0, A = Acknowledge, P = Stop Condition

\*The sub-address uses only the first 5 bits, D0, D1, D2, D3 and D4.

\*\*Stop can be delayed until all of the data registers have been written.



Figure 2. Bit Assignments

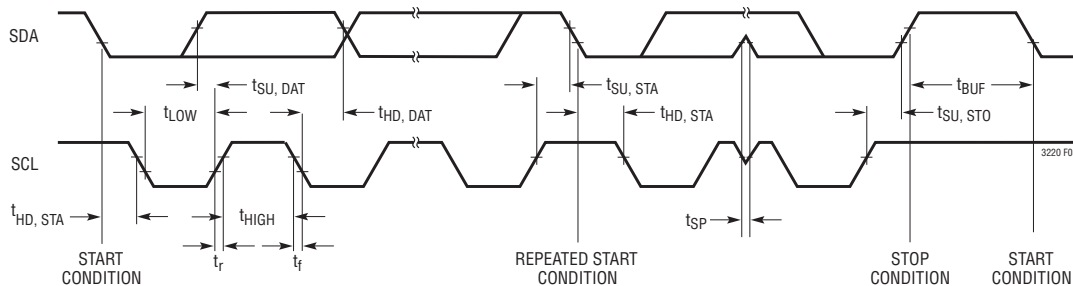

Figure 3. Timing Parameters

## OPERATION

### Sub-Address Byte

| MSB |   |   |   |   |   |   | LSB |       | Register       | Function |
|-----|---|---|---|---|---|---|-----|-------|----------------|----------|
| 7   | 6 | 5 | 4 | 3 | 2 | 1 | 0   |       |                |          |
| 0   | 0 | 0 | 0 | 0 | 0 | 0 | 0   | REG0  | COMMAND        |          |
| 0   | 0 | 0 | 0 | 0 | 0 | 0 | 1   | REG1  | ULED1          |          |
| 0   | 0 | 0 | 0 | 0 | 0 | 1 | 0   | REG2  | ULED2          |          |
| 0   | 0 | 0 | 0 | 0 | 0 | 1 | 1   | REG3  | ULED3          |          |
| 0   | 0 | 0 | 0 | 0 | 1 | 0 | 0   | REG4  | ULED4          |          |
| 0   | 0 | 0 | 0 | 0 | 1 | 0 | 1   | REG5  | ULED5          |          |
| 0   | 0 | 0 | 0 | 0 | 1 | 1 | 0   | REG6  | ULED6          |          |
| 0   | 0 | 0 | 0 | 0 | 1 | 1 | 1   | REG7  | ULED7          |          |
| 0   | 0 | 0 | 0 | 1 | 0 | 0 | 0   | REG8  | ULED8          |          |
| 0   | 0 | 0 | 0 | 1 | 0 | 0 | 1   | REG9  | ULED9          |          |
| 0   | 0 | 0 | 0 | 1 | 0 | 1 | 0   | REG10 | ULED10         |          |
| 0   | 0 | 0 | 0 | 1 | 0 | 1 | 1   | REG11 | ULED11         |          |
| 0   | 0 | 0 | 0 | 1 | 1 | 0 | 0   | REG12 | ULED12         |          |
| 0   | 0 | 0 | 0 | 1 | 1 | 0 | 1   | REG13 | ULED13         |          |
| 0   | 0 | 0 | 0 | 1 | 1 | 1 | 0   | REG14 | ULED14         |          |
| 0   | 0 | 0 | 0 | 1 | 1 | 1 | 1   | REG15 | ULED15         |          |
| 0   | 0 | 0 | 1 | 0 | 0 | 0 | 0   | REG16 | ULED16         |          |
| 0   | 0 | 0 | 1 | 0 | 0 | 0 | 1   | REG17 | ULED17         |          |
| 0   | 0 | 0 | 1 | 0 | 0 | 1 | 0   | REG18 | ULED18         |          |
| 0   | 0 | 0 | 1 | 0 | 0 | 1 | 1   | REG19 | GRAD/<br>BLINK |          |

### REG0, Command Byte.

#### Register Sub-Address = 0000

| MSB    |        |        |        |          |         |           | LSB         |
|--------|--------|--------|--------|----------|---------|-----------|-------------|
| D7     | D6     | D5     | D4     | D3       | D2      | D1        | D0          |
| Unused | Unused | Unused | Unused | Shutdown | Force2x | Force1p5x | Quick write |

|             |                                        |                                                                          |
|-------------|----------------------------------------|--------------------------------------------------------------------------|
| Quick write | 0                                      | Serial write to each register                                            |
|             | 1                                      | Parallel write, REG1 data is written to all eighteen universal registers |
| Force1p5    | 1                                      | Forces charge pump into 1.5x mode                                        |
|             | 0                                      | Enables mode logic to control mode changes based on dropout signal       |
| Force2x     | 1                                      | Forces charge pump into 2x mode                                          |
|             | 0                                      | Enables mode logic to control mode changes based on dropout signal       |
| Force1x     | D2 (Force1p5x) = 1<br>D3 (Force2x) = 1 |                                                                          |
|             |                                        | Forces Charge Pump into 1x Mode                                          |
| Shutdown    | 1                                      | Shuts down part while preserving data in registers                       |
|             | 0                                      | Normal operation                                                         |

## OPERATION

### Data Bytes

REG1 to REG18, Universal LED 6-bit linear DAC data with blink/gradation.

**Sub-Address 00001 to 10010 per Sub-Address Table**

|                       | Blink/Gradation/Dropout Enable |       | LED Current Data |       |       |       |       |       |
|-----------------------|--------------------------------|-------|------------------|-------|-------|-------|-------|-------|
|                       | MSB                            |       | LSB              |       |       |       |       |       |
|                       | Bit 7                          | Bit 6 | Bit 5            | Bit 4 | Bit 3 | Bit 2 | Bit 1 | Bit 0 |
| Normal                | 0                              | 0     | D5               | D4    | D3    | D2    | D1    | D0    |
| Blink Enabled         | 0                              | 1     | D5               | D4    | D3    | D2    | D1    | D0    |
| Gradation Enabled     | 1                              | 0     | D5               | D4    | D3    | D2    | D1    | D0    |
| GPO Mode*             |                                |       |                  |       |       |       |       |       |
| Strong Pull-Down Mode | 1                              | 1     | 0                | 0     | 0     | 0     | 0     | 0     |
| Current Limited Mode  | 1                              | 1     | D5               | D4    | D3    | D2    | D1    | D0    |
| High Impedance/Off    | 0                              | 0     | 0                | 0     | 0     | 0     | 0     | 0     |

\*(Gradation/Blink/Dropout Off)

**REG19, Gradation and Blinking**

| MSB    |        |                       |     |     |     |     | LSB |
|--------|--------|-----------------------|-----|-----|-----|-----|-----|
| D7     | D6     | D5                    | D4  | D3  | D2  | D1  | D0  |
| Unused | Unused | Unused                | GB4 | GB3 | GB2 | GB1 | Up  |
| Up     | 0      | Gradation counts down |     |     |     |     |     |
|        | 1      | Gradation counts up   |     |     |     |     |     |

| Blink Times and Period |          |         |        | Gradation Ramp Times and Period |          |           |          |
|------------------------|----------|---------|--------|---------------------------------|----------|-----------|----------|
| D4 (GB4)               | D3 (GB3) | On Time | Period | D2 (GB2)                        | D1 (GB1) | Ramp Time | Period   |
| 0                      | 0        | 0.625s  | 1.25s  | 0                               | 0        | Disabled  | Disabled |
| 0                      | 1        | 0.156s  | 1.25s  | 0                               | 1        | 0.24s     | 0.313s   |
| 1                      | 0        | 0.625s  | 2.5s   | 1                               | 0        | 0.48s     | 0.625s   |
| 1                      | 1        | 0.156s  | 2.5s   | 1                               | 1        | 0.96s     | 1.25s    |

## OPERATION

### Bus Speed

The I<sup>2</sup>C port is designed to be operated at speeds up to 400kHz. It has built-in timing delays to ensure correct operation when addressed from an I<sup>2</sup>C compliant master device. It also contains input filters designed to suppress glitches should the bus become corrupted.

### Start and Stop Conditions

A bus-master signals the beginning of a communication to a slave device by transmitting a Start condition.

A Start condition is generated by transitioning SDA from high to low while SCL is high. When the master has finished communicating with the slave, it issues a Stop condition by transitioning SDA from low to high while SCL is high. The bus is then free for communication with another I<sup>2</sup>C device.

### Byte Format

Each byte sent to the LTC3220/LTC3220-1 must be 8 bits long followed by an extra clock cycle for the Acknowledge bit to be returned by the LTC3220/LTC3220-1. The data should be sent to the LTC3220/LTC3220-1 most significant bit (MSB) first.

### Acknowledge

The Acknowledge signal is used for handshaking between the master and the slave. An Acknowledge (active low) generated by the slave (LTC3220/LTC3220-1) lets the master know that the latest byte of information was received. The Acknowledge related clock pulse is generated by the master. The master releases the SDA line (high) during the Acknowledge clock cycle. The slave-receiver must pull down the SDA line during the Acknowledge clock pulse so that it remains a stable low during the high period of this clock pulse.

### Slave Address

Each version of LTC3220/LTC3220-1 responds to a unique address which has been factory programmed (Table 1). The eighth bit of the address byte (R/W) must be 0 for the LTC3220/LTC3220-1 to recognize the address since it is a write only device. This effectively forces the address to be 8 bits long where the least significant bit of the address is 0. If the correct seven bit address is given but the R/W bit is 1, the LTC3220/LTC3220-1 will not respond.

**Table 1. LTC3220/LTC3220-1 Factory Programmed Slave Address**

| PART NUMBER | SLAVE ADDRESS |
|-------------|---------------|
| LTC3220     | 0011100       |
| LTC3220-1   | 0011101       |

## OPERATION

### Bus Write Operation

The master initiates communication with the LTC3220/LTC3220-1 with a Start condition and a 7-bit address followed by the Write Bit R/W = 0. If the address matches that of the LTC3220/LTC3220-1, the LTC3220/LTC3220-1 return an Acknowledge. The master should then deliver the most significant sub-address byte for the data register to be written. Again the LTC3220/LTC3220-1 acknowledge and then the data is delivered starting with the most significant bit. This cycle is repeated until all of the required data registers have been written. Any number of data latches can be written. Each data byte is transferred to an internal holding latch upon the return of an Acknowledge. After all data bytes have been transferred to the LTC3220/LTC3220-1, the master may terminate the communication with a Stop condition. Alternatively, a Repeat-Start condition can be initiated by the master and another chip on the I<sup>2</sup>C bus can be addressed. This cycle can continue indefinitely and the LTC3220/LTC3220-1 will remember the last input of valid data that it received. Once all chips on the bus have been addressed and sent valid data, a global Stop condition can be sent and the LTC3220/LTC3220-1 will update all registers with the data that it had received.

In certain circumstances the data on the I<sup>2</sup>C bus may become corrupted. In these cases the LTC3220/LTC3220-1 respond appropriately by preserving only the last set of complete data that it has received. For example, assume the LTC3220/LTC3220-1 has been successfully addressed and is receiving data when a Stop condition mistakenly occurs. The LTC3220/LTC3220-1 will ignore this Stop condition and will not respond until a new Start condition, correct address, sub-address and new set of data and Stop condition are transmitted.

Likewise, if the LTC3220/LTC3220-1 were previously addressed and sent valid data but not updated with a Stop, they will respond to any Stop that appears on the bus with only one exception, independent of the number of Repeat-Start's that have occurred. If a Repeat-Start is given and the LTC3220/LTC3220-1 successfully acknowledge their addresses and first byte, they will not respond to a Stop until all bytes of the new data have been received and acknowledged.

### Quick Write

Registers REG1 to REG18 can be written in parallel by setting Bit 0 of REG 0 high. When this bit is set high the next write sequence to REG1 will write the data to REG1 through REG18, which are all of the universal LED registers.

## APPLICATIONS INFORMATION

### $V_{IN}$ , CPO Capacitor Selection

The style and value of the capacitors used with the LTC3220/LTC3220-1 determine several important parameters such as regulator control loop stability, output ripple, charge pump strength and minimum start-up time.

To reduce noise and ripple, it is recommended that low equivalent series resistance (ESR) ceramic capacitors are used for both  $C_{VIN}$  and  $C_{CPO}$ . Tantalum and aluminum capacitors are not recommended due to high ESR.

The value of  $C_{CPO}$  directly controls the amount of output ripple for a given load current. Increasing the size of  $C_{CPO}$  will reduce output ripple at the expense of higher start-up current. The peak-to-peak output ripple of the 1.5x mode is approximately given by the expression:

$$V_{RIPPLEP-P} = \frac{I_{OUT}}{3f_{OSC} \cdot C_{CPO}} \quad (3)$$

where  $f_{OSC}$  is the LTC3220/LTC3220-1 oscillator frequency or typically 850kHz and  $C_{CPO}$  is the output storage capacitor.

The output ripple in 2x mode is very small due to the fact that load current is supplied on both cycles of the clock.

Both type and value of the output capacitor can significantly affect the stability of the LTC3220/LTC3220-1. As shown in the Block Diagram, the LTC3220/LTC3220-1 use a control loop to adjust the strength of the charge pump to match

the required output current. The error signal of the loop is stored directly on the output capacitor. The output capacitor also serves as the dominant pole for the control loop. To prevent ringing or instability, it is important for the output capacitor to maintain at least 3.2 $\mu$ F of capacitance over all conditions and the ESR should be less than 80m $\Omega$ .

Multilayer ceramic chip capacitors typically have exceptional ESR performance. MLCCs combined with a tight board layout will result in very good stability. As the value of  $C_{CPO}$  controls the amount of output ripple, the value of  $C_{VIN}$  controls the amount of ripple present at the input pin ( $V_{IN}$ ). The LTC3220/LTC3220-1 input current will be relatively constant while the charge pump is either in the input charging phase or the output charging phase but will drop to zero during the clock nonoverlap times. Since the nonoverlap time is small (~25ns), these missing “notches” will result in only a small perturbation on the input power supply line. Note that a higher ESR capacitor such as tantalum will have higher input noise due to the higher ESR. Therefore, ceramic capacitors are recommended for low ESR. Input noise can be further reduced by powering the LTC3220/LTC3220-1 through a very small series inductor as shown in Figure 4. A 10nH inductor will reject the fast current notches, thereby presenting a nearly constant current load to the input power supply. For economy, the 10nH inductor can be fabricated on the PC board with about 1cm (0.4”) of PC board trace.

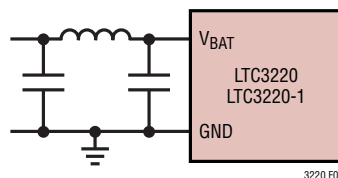

**Figure 4. 10nH Inductor Used for Input Noise Reduction (Approximately 1cm of Board Space)**



## APPLICATIONS INFORMATION

### Flying Capacitor Selection

**Warning: Polarized capacitors such as tantalum or aluminum should never be used for the flying capacitors since their voltage can reverse upon start-up of the LTC3220/LTC3220-1. Ceramic capacitors should always be used for the flying capacitors.**

The flying capacitors control the strength of the charge pump. In order to achieve the rated output current it is necessary to have at least 1.6 $\mu$ F of capacitance for each of the flying capacitors. Capacitors of different materials lose their capacitance with higher temperature and voltage at different rates. For example, a ceramic capacitor made of X7R material will retain most of its capacitance from  $-40^{\circ}\text{C}$  to  $85^{\circ}\text{C}$ , whereas a Z5U or Y5V style capacitor will lose considerable capacitance over that range. Z5U and Y5V capacitors may also have a very poor voltage coefficient causing them to lose 60% or more of their capacitance when the rated voltage is applied. Therefore, when comparing different capacitors, it is often more appropriate to compare the amount of achievable capacitance for a given case size rather than comparing the specified capacitance value. For example, over rated voltage and temperature conditions, a 1 $\mu$ F, 10V, Y5V ceramic capacitor in a 0603 case may not provide any more capacitance than a 0.22 $\mu$ F, 10V, X7R available in the same case. The capacitor manufacturer's data sheet should be consulted to determine what value of capacitor is needed to ensure minimum capacitances at all temperatures and voltages.

Table 2 shows a list of ceramic capacitor manufacturers and how to contact them:

**Table 2. Recommended Capacitor Vendors**

|             |                                                      |
|-------------|------------------------------------------------------|
| AVX         | <a href="http://www.avxcorp.com">www.avxcorp.com</a> |
| Kemet       | <a href="http://www.kemet.com">www.kemet.com</a>     |
| Murata      | <a href="http://www.murata.com">www.murata.com</a>   |
| Taiyo Yuden | <a href="http://www.t-yuden.com">www.t-yuden.com</a> |
| Vishay      | <a href="http://www.vishay.com">www.vishay.com</a>   |

### Layout Considerations and Noise

The LTC3220/LTC3220-1 have been designed to minimize EMI. However due to their high switching frequency and the transient currents produced by the LTC3220/LTC3220-1, careful board layout is necessary. A true ground plane and short connections to all capacitors will improve performance and ensure proper regulation under all conditions.

The flying capacitor pins C1P, C2P, C1M and C2M have controlled edge rate waveforms. The large  $dv/dt$  on these pins can couple energy capacitively to adjacent PCB runs. Magnetic fields can also be generated if the flying capacitors are not close to the LTC3220/LTC3220-1 (i.e., the loop area is large). To decouple capacitive energy transfer, a Faraday shield may be used. This is a grounded PCB trace between the sensitive node and the LTC3220/LTC3220-1 pins. For a high quality AC ground, it should be returned to a solid ground plane that extends all the way to the LTC3220/LTC3220-1.

## APPLICATIONS INFORMATION

### Power Efficiency

To calculate the power efficiency ( $\eta$ ) of an LED driver chip, the LED power should be compared to the input power. The difference between these two numbers represents lost power whether it is in the charge pump or the current sources. Stated mathematically, the power efficiency is given by:

$$\eta = \frac{P_{LED}}{P_{IN}} \quad (4)$$

The efficiency of the LTC3220/LTC3220-1 depends upon the mode in which it is operating. Recall that the LTC3220/LTC3220-1 operate as pass switches, connecting  $V_{IN}$  to GPO, until dropout is detected at the  $I_{LED}$  pin. This feature provides the optimum efficiency available for a given input voltage and LED forward voltage. When it is operating as a switch, the efficiency is approximated by:

$$\eta = \frac{P_{LED}}{P_{IN}} = \frac{V_{LED} \cdot I_{LED}}{V_{IN} \cdot I_{IN}} = \frac{V_{LED}}{V_{IN}} \quad (5)$$

since the input current will be very close to the sum of the LED currents.

At moderate to high output power, the quiescent current of the LTC3220/LTC3220-1 is negligible and the expression above is valid.

Once dropout is detected at any LED pin, the LTC3220/LTC3220-1 enable the charge pump in 1.5x mode.

In 1.5x boost mode, the efficiency is similar to that of a linear regulator with an effective input voltage of 1.5 times the actual input voltage. This is because the input current for a 1.5x charge pump is approximately 1.5 times the load current. In an ideal 1.5x charge pump, the power efficiency would be given by:

$$\eta_{IDEAL} = \frac{P_{LED}}{P_{IN}} = \frac{V_{LED} \cdot I_{LED}}{V_{IN} \cdot 1.5 \cdot I_{LED}} = \frac{V_{LED}}{1.5 \cdot V_{IN}}$$

Similarly, in 2x boost mode, the efficiency is similar to that of a linear regulator with an effective input voltage of 2 times the actual input voltage. In an ideal 2x charge pump, the power efficiency would be given by:

$$\eta_{IDEAL} = \frac{P_{LED}}{P_{IN}} = \frac{V_{LED} \cdot I_{LED}}{V_{IN} \cdot 2 \cdot I_{LED}} = \frac{V_{LED}}{2 \cdot V_{IN}}$$

### Thermal Management

For higher input voltages and maximum output current, there can be substantial power dissipation in the LTC3220/LTC3220-1. If the junction temperature increases above approximately 150°C, the thermal shutdown circuitry will automatically deactivate the output current sources and charge pump. To reduce maximum junction temperature, a good thermal connection to the PC board is recommended. Connecting the Exposed Pad to a ground plane and maintaining a solid ground plane under the device will reduce the thermal resistance of the package and PC board considerably.



## TYPICAL APPLICATION

### Cellular Phone Multi-Display LED Controller with Auxiliary Current Source Output

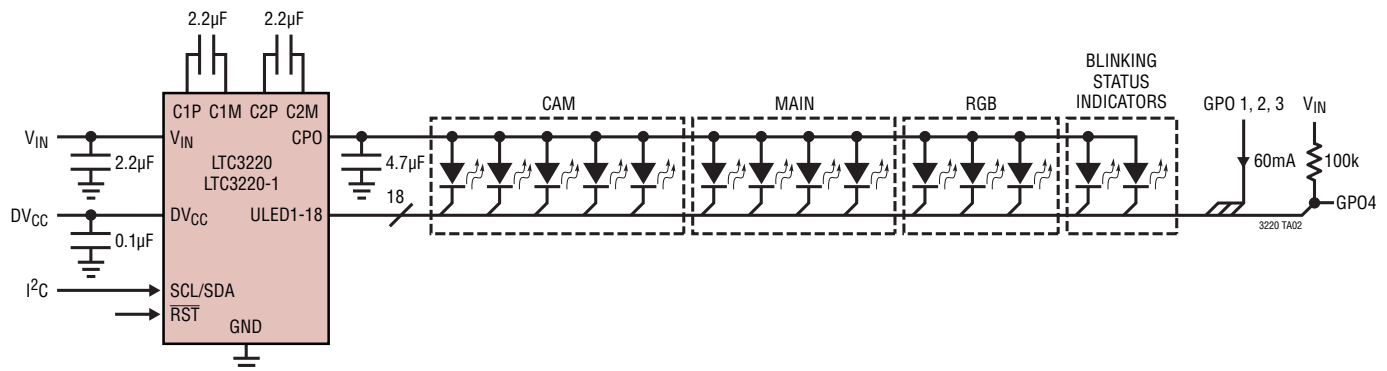

## RELATED PARTS

| PART NUMBER             | DESCRIPTION                                                                            | COMMENTS                                                                                                                                            |
|-------------------------|----------------------------------------------------------------------------------------|-----------------------------------------------------------------------------------------------------------------------------------------------------|
| LTC3205                 | 250mA, 1MHz, Multi-Display LED Controller                                              | $V_{IN}$ : 2.8V to 4.5V, $V_{OUT(MAX)}$ = 5.5V, $I_Q$ = 50µA, $I_{SD}$ < 1µA, QFN Package                                                           |
| LTC3206                 | 400mA, 800kHz, Multi-Display LED Controller                                            | $V_{IN}$ : 2.8V to 4.5V, $V_{OUT(MAX)}$ = 5.5V, $I_Q$ = 50µA, $I_{SD}$ < 1µA, QFN Package                                                           |
| LTC3207                 | 600mA Universal Multi-Output LED/CAM Driver                                            | $V_{BAT}$ : 2.9V to 5.5V, 12 Universal Individually Controlled LED Drivers, One Camera Driver, 4mm × 4mm QFN Package                                |
| LTC3208                 | High Current Software Configurable Multi-Display LED Controller                        | $V_{IN}$ : 2.9V to 4.5V, $V_{OUT(MAX)}$ = 5.5V, $I_Q$ = 250µA, $I_{SD}$ < 3µA, 17 Current Sources (MAIN, SUB, RGB, CAM, AUX), 5mm × 5mm QFN Package |
| LTC3209-1/<br>LTC3209-2 | 600mA MAIN/Camera/AUX LED Controller                                                   | $V_{IN}$ : 2.9V to 4.5V, $I_Q$ = 400mA, Up to 94% Efficiency, 4mm × 4mm QFN-20 Package                                                              |
| LTC3210                 | MAIN/CAM LED Controller in 3mm × 3mm QFN                                               | $V_{IN}$ : 2.9V to 4.5V, $I_Q$ = 400µA, 3-Bit DAC Brightness Control for MAIN and CAM LEDs, 3mm × 3mm QFN Package                                   |
| LTC3210-1               | MAIN/CAM LED Controller with 64-Step Brightness Control                                | 6-Bit DAC Brightness Control for MAIN and 3-Bit Brightness Control for CAM, 3mm × 3mm QFN Package                                                   |
| LTC3210-2               | MAIN/CAM LED Controller with 32-Step Brightness Control                                | Drives 4 MAIN LEDs, 3mm × 3mm QFN Package                                                                                                           |
| LTC3210-3               | MAIN/CAM LED Controller with 32-Step Brightness Control                                | Drives 3 MAIN LEDs, 3mm × 3mm QFN Package                                                                                                           |
| LTC3212                 | RGB LED Driver and Charge Pump                                                         | Drives RGB LEDs, 25mA/LED × 3, $V_{IN}$ Range: 2.9V to 4.5V, 2mm × 3mm DFN Package                                                                  |
| LTC3214                 | 500mA Camera LED Charge Pump                                                           | $V_{IN}$ : 2.9V to 4.5V, Single Output, 3mm × 3mm DFN Package                                                                                       |
| LTC3215                 | 700mA Low Noise High Current LED Charge Pump                                           | $V_{IN}$ : 2.9V to 4.4V, $V_{OUT(MAX)}$ = 5.5V, $I_Q$ = 300µA, $I_{SD}$ < 2.5µA, DFN Package                                                        |
| LTC3216                 | 1A Low Noise High Current LED Charge Pump with Independent Flash/Torch Current Control | $V_{IN}$ : 2.9V to 4.4V, $V_{OUT(MAX)}$ = 5.5V, $I_Q$ = 300µA, $I_{SD}$ < 2.5µA, DFN Package                                                        |
| LTC3217                 | 600mA Low Noise Multi-LED Camera Light                                                 | $V_{IN}$ : 2.9V to 4.4V, $I_Q$ = 400µA, Four 100mA Outputs, QFN Package                                                                             |
| LTC3218                 | 400mA Single-Wire Camera LED Charge Pump                                               | 91% Efficiency, $V_{IN}$ Range: 2.9V to 4.5V, 2mm × 3mm DFN Package, High Side Current Sense                                                        |
| LTC3219                 | 250mA Universal Multi-Output LED Driver                                                | $V_{BAT}$ 2.9V to 5.5V, Nine Universal Individually Controlled LED Drivers, 3mm × 3mm QFN Package                                                   |
| LTC3440/LTC3441         | 600mA/1.2A $I_{OUT}$ , 2MHz/1MHz, Synchronous Buck-Boost DC/DC Converter               | $V_{IN}$ : 2.4V to 5.5V, $V_{OUT(MAX)}$ = 5.25V, $I_Q$ = 25µA/50µA, $I_{SD}$ < 1µA, MS/DFN Packages                                                 |
| LTC3443                 | 600mA/1.2A $I_{OUT}$ , 600kHz, Synchronous Buck-Boost DC/DC Converter                  | $V_{IN}$ : 2.4V to 5.5V, $V_{OUT(MAX)}$ = 5.25V, $I_Q$ = 28µA, $I_{SD}$ < 1µA, DFN Package                                                          |
| LTC3453                 | 1MHz, 800mA Synchronous Buck-Boost High Power LED Driver                               | $V_{IN(MIN)}$ : 2.7V to 5.5V, $V_{IN(MAX)}$ : 2.7V to 4.5V, $I_Q$ = 2.5mA, $I_{SD}$ < 6µA, QFN Package                                              |

32201fb