

# TACT Switch™ 6.2 × 7.15mm Sidepush™ (Snap-in Type)

SKRD Series



2pins with simple snap-in package.

- Detector
- Push
- Slide
- Rotary
- Encoders
- Power

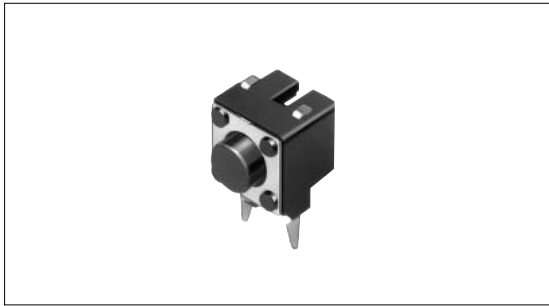

- Dual-in-line Package Type
- TACT Switch™
- Custom-Products

## Product Line

Product No.	Operating force	Operating direction	Travel (mm)	Rating (max.)	Rating (min.)	Operating life (5mA 5V DC)	Initial contact resistance	Stem color	Minimum order unit(pcs.)
SKRDLAA010	0.98N	Horizontal	0.25	50mA 12V DC	10μ A 1V DC	100,000cycles	100m max.	Black	1,000
SKRDLBA010	1.57N							Dark gray	

## Dimensions

Unit:mm

- Sharp Feeling
- Soft Feeling
- Snap-in Type
- Surface Mount Type
- Radial Type

Style	PC board mounting hole dimensions (Viewed from switch mounting face)

## Circuit Diagram

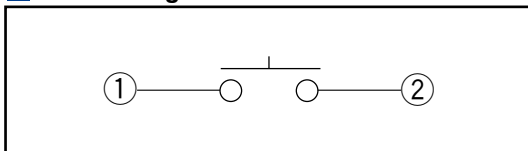











## Notes

1. Please use 1.6mm thick PC boards.
2. Please use single-sided PC boards.

Refer to P.306 for soldering conditions.

# List of Varieties

## Sharp Feeling Type

Series	SKHR	SKHL	SKHH	SKHW	SKRD	SKQJ	SKHL	SKHH	SKQJ	SKHJ	SKQB	
Photo												
Type	Snap-in											
Features				Dust-proof type	Horizontal type	Horizontal type			With LED	Water-proof		
Operating direction	Vertical											
	Horizontal											
Dimensions (mm)	W	4.5	6	6		6.2	6.6	7.3	7.5		8	10
	D		3.5			7.15		7.22	7.85			
	H	3.8	4.3		7.4	5	4.3	7.4	7.3	8.5	5	
Operation force coverage	1N	↕	↕	↕	↕	↕	↕	↕	↕	↕	↕	
	5N			↕								
Ground terminal												
Operating temperature range	-20 to +70 SKHJ/HL( Vertical Type ) /QJ											
	-30 to +85											
Electrical performance	Insulation resistance	100M min. 100V DC										
	Voltage proof	250V AC for 1min.										
Durability	Vibration	10 to 55 to 10Hz/min., the amplitude is 1.5mm for all the frequencies, in the 3 direction of X, Y and Z for 2hours respectively										
	Lifetime	Shall be in accordance with individual specifications.										
Environmental performance	Cold	-30 ± 2 for 96h										
	Dry heat	80 ± 2 for 96h										
	Damp heat	60 ± 2 , 90 to 95%RH for 96h										
Page	252	253	255	259	260	261	253	255	261	263	265	

W : Width. The most outer dimension excluding terminal portion.  
 D : Depth. The most outer dimension excluding terminal portion.  
 H : Height. The minimum dimension if there are variances.

TACT Switch™ Soldering Conditions .....306  
 TACT Switch™ Cautions .....307  
 Product Line of Knob for TACT Switch™ .....308

### Note

The automotive operating temperature range to be individually discussed upon request.

- Detector
- Push
- Slide
- Rotary
- Encoders
- Power
- Dual-in-line Package Type
- TACT Switch™
- Custom-Products

- Sharp Feeling
- Soft Feeling
- Snap-in Type
- Surface Mount Type
- Radial Type

## Soldering Conditions

### Condition for Reflow

Available for Surface Mount Type.

1. Heating method: Double heating method with infrared heater.
2. Temperature measurement: Thermocouple 0.1 to 0.2 CA(K) or CC(T) at solder joints( copper foil surface ). A heat resistive tape should be used to fix thermocouple.
3. Temperature profile



### Note

1. The above temperature shall be measured on the mounting surface of a PC board. There are cases where the PC board's temperature greatly differs from that of the switch, depending on the material, size, thickness of PC boards and others. The above-stated conditions shall also apply to switch surface temperatures.
2. Soldering conditions differ depending on reflow soldering machines. Prior verification of soldering condition is highly recommended.

### Conditions for Auto-dip

Available for Snap-in Type and Radial Type  
(Except SKHJ, SKHL, SKQJ, SKQK, SKEG series)

Items	Condition
Flux built-up	Mounting surface should not be exposed to flux
Preheating temperature	Ambient temperature of the soldered surface of PC board. 100 max.
Preheating time	60s max.
Soldering temperature	260 max.
Duration of immersion	5s max.
Number of soldering	2times max.

### Manual Soldering ( Except SKRT Series )

Items	Condition
Soldering temperature	350 max.
Duration of soldering	3s max.
Capacity of soldering iron	60W max.

### Notes

1. Consult with us for availability of TACT Switch™ washing.
2. Prevent flux penetration from the top side of the TACT Switch™.
3. Switch terminals and a PC board should not be coated with flux prior to soldering.
4. The second soldering should be done after the switch is stable with normal temperature.
5. Use the flux with a specific gravity of min 0.81.  
( EC-19S-8 by TAMURA Corporation, or equivalents. )

Detector  
Push  
Slide  
Rotary  
Encoders  
Power  
Dual-in-line Package Type  
TACT Switch™  
Custom-Products

Sharp Feeling  
Soft Feeling  
Snap-in Type  
Surface Mount Type  
Radial Type