

POWER RELAY

1 POLE—16A (CADMIUM FREE CONTACTS TYPE)

FTR-K2 SERIES

RoHS compliant

■ FEATURES

- SPST-NO 16A
- HIGH ISOLATION
Insulation Distance: Minimum 6mm between coil and contact
Dielectric Strength: 4KV
Surge Strength: 10KV
- TV-5 rating
- HEAT RESISTANCE, FLAMMABILITY
Class B (130° C) insulation, flammability 94V-0
- CADMIUM FREE CONTACT FOR ECO-PROGRAM
- SAFETY STANDARDS
UL, CSA, VDE approved, SEMKO (pending)
UL/CSA TV-5 rating approved
- RoHS compliant since date code: 0437L2
Please see page 8 for more information



■ ORDERING INFORMATION

[Example] FTR-K2 A K 012 T -()
 (a) (b) (c) (d) (e) (f)

(a)	Series name	FTR-K2: FTR-K2 series (16A)
(b)	Contact arrangement	A: 1 Form A (SPST-NO)
(c)	Coil type	K: Standard (530mW)
(d)	Coil nominal voltage	005 : 5DC 012 : 12DC 048 : 48DC 006 : 6DC 018 : 18DC 009 : 9DC 024 : 24DC
(e)	Contact material	T: Silver-tin oxide (TV-5)
(f)	Option	OK: 1.0mm wide contact gap

FTR-K2 Series

■ PART NUMBERS

Standard: 530 mW

Ordering Part Number	Series	Contact	Coil Power	Coil Voltage	Contact Material
FTR-K2AK005T	FTR-K2	1 form A	K: 530mW	5	T: Silver tin oxide (TV-5 rated)
FTR-K2AK006T				6	
FTR-K2AK009T				9	
FTR-K2AK012T				12	
FTR-K2AK018T				18	
FTR-K2AK024T				24	
FTR-K2AK048T				48	

■ COIL DATA CHART

Standard Type (530mW)

Coil Voltage	Nominal Voltage (VDC)	Max. Coil Voltage* ¹	Coil Resistance (±10%)	Must Operate Voltage* ²	Must Release Voltage* ²
005	5	8.5 VDC	47 Ω	3.5 VDC	0.25 VDC
006	6	10.2 VDC	68 Ω	4.2 VDC	0.3 VDC
009	9	15.3 VDC	155 Ω	6.3 VDC	0.45 VDC
012	12	20.4 VDC	270 Ω	8.4 VDC	0.6 VDC
018	18	30.6 VDC	610 Ω	12.6 VDC	0.9 VDC
024	24	40.8 VDC	1,110Ω	16.8 VDC	1.2 VDC
048	48	81.6 VDC	4,400 Ω	33.6 VDC	2.4 VDC

Note: All values in the table are measured at 20°C.

*1: No contact current at 20°C

*2: Specified values are subject to pulse wave voltage

FTR-K2 Series

■ SPECIFICATIONS

Item		FTR-K2AK ()T	
Contact	Arrangement	1 form A (SPST-NO)	
	Material	Silver tin oxide	
	Resistance (initial)	Maximum 100 mΩ (at 6VDC, 1A)	
	Rating (resistive)	250 VAC / 30 VDC / 16A	
	Maximum Carrying Current	16A	
	Maximum Switching Rating	4000VA / 480W	
	Maximum Switching Voltage	400VAC / 300VDC	
	Minimum Switching Load*	100 mA, 5 VDC	
Coil	Nominal Power (20°C)	530 mW	
	Operate Power (20°C)	260 mW	
	Operating Temperature	-40°C to +70°C (no frost)	
Time Value	Operate Time (at nominal voltage)	Maximum 15 ms	
	Release Time (at nominal voltage)	Maximum 5 ms	
Life	Mechanical	2 x 10 ⁶ operations minimum	
	Electrical	AC Contact rating	100 x 10 ³ operations min.
		DC Contact Rating	100 x 10 ³ operations minimum
		Lamp load (TV-5)	25 x 10 ³ operations minimum
Other	Vibration Resistance	Misoperation	10 to 55 Hz, at double amplitude of 1.5 mm
		Endurance	10 to 55Hz, at double amplitude of 1.5 mm
	Shock Resistance	Misoperation	200m/s ² (11±1ms)
		Endurance	1,000m/s ² (11±1ms)
	Weight	Approximately 13g	

* Minimum switching loads mentioned above are reference values. Please perform the confirmation test with the actual load before production since reference values may vary according to switching frequencies, environmental conditions and expected reliability levels.

FTR-K2 Series

■ INSULATION

Item	FTR-K2	Note
Resistance (initial)	Minimum 1,000 MΩ 1 min.	at 500 VDC
Dielectric Strength	open contacts	1,000 VAC (50/60 Hz) 1 min.
	coil and contacts	4,000 VAC (50/60 Hz) 1 min.
Surge Voltage (coil and contact)	10,000 V	1.2 x 50µs standard wave
Clearance/Creepage	6 mm / 6 mm	
Insulation (DIN EN61810-1 VDE0435)		
Voltage	250 V	
Pollution	2	
Isolation material group	III a	
Isolation category / Reference voltage (VDE 0110b)	B / 250 V	

■ SAFETY STANDARDS

Type	Compliance	Contact rating
UL	UL 508 E63614	Flammability: UL 94-V0 (plastics) 16A, 30VDC (resistive) 16A, 125VAC (resistive)
CSA	C22.2 No. 14 LR 40304	10A, 277VAC (resistive) 1/2 HP, 125VAC 1 HP, 277VAC TV-5, 120 VAC Pilot duty: A300
VDE	0435, 0860	16A, 250 VAC (cosØ=1) 8A, 250 VAC cosØ=0.4) 18A, 30 VDC (0ms) 250VAC 5/80A inrush
SEMKO	EN 61058-1: 1992 AND A1 EN 61095:1993 and A1+A11	250 VAC, 10 (3) or 5/80 40T70

Complies with CQC, NEMKO, DEMKO, FIMKO,

FTR-K2 Series

CHARACTERISTIC DATA

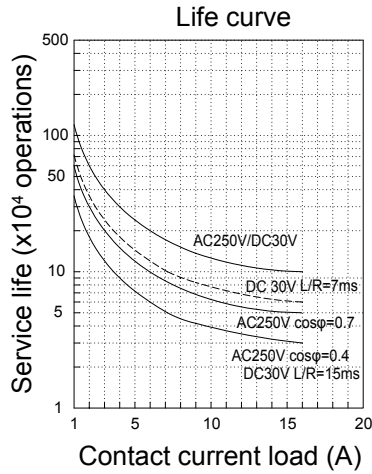
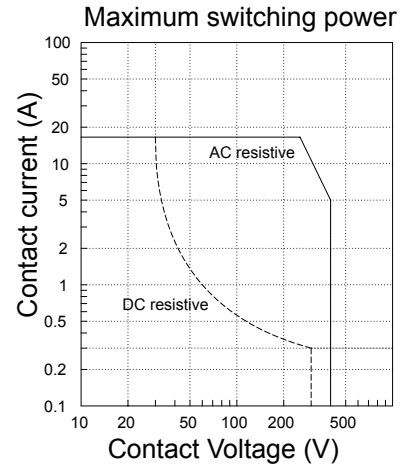
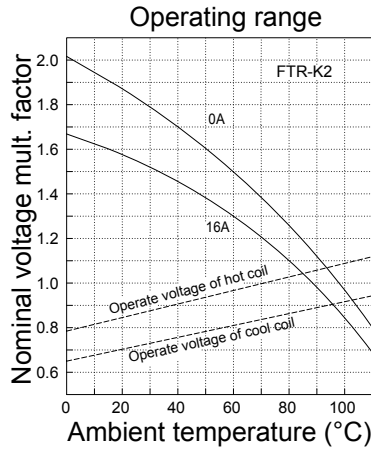
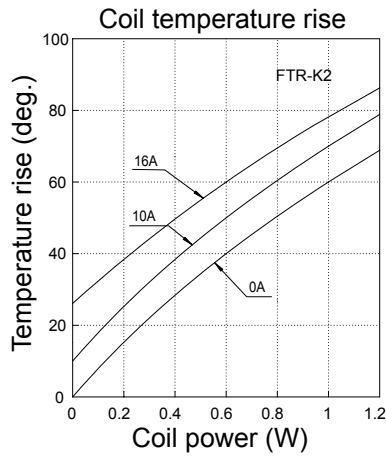

REFERENCE DATA

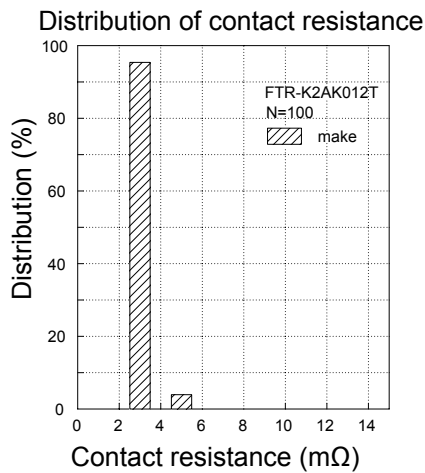
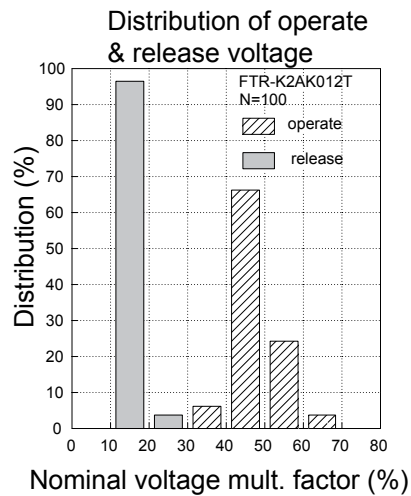

FTR-K2 Series

■ DIMENSIONS

● Dimensions

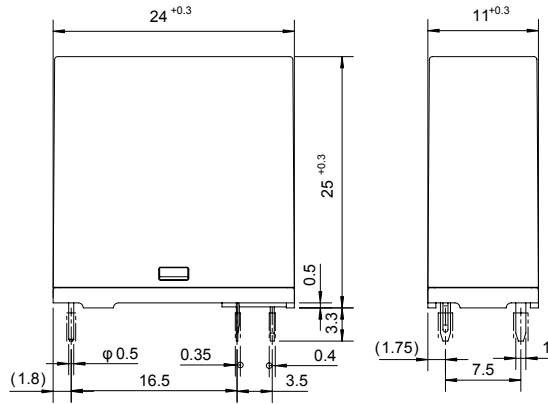

● Schematics (BOTTOM VIEW)

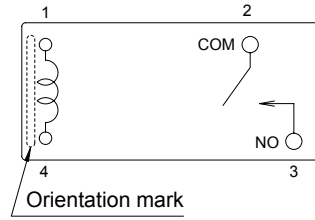

● PC board mounting hole layout (BOTTOM VIEW)

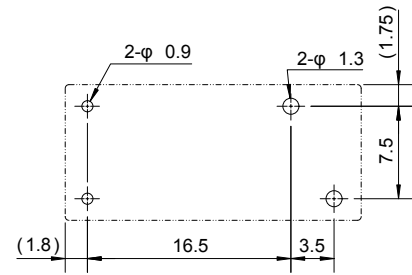

Unit: mm (in.)

RoHS Compliance and Lead Free Relay Information

1. General Information

- Relays produced after the specific date code that is indicated on each data sheet are lead-free now. All of our signal and power relays are lead-free. Please refer to Lead-Free Status Info. (<http://www.fujitsu.com/us/downloads/MICRO/fcai/relays/lead-free-letter.pdf>)
- Lead free solder paste currently used in relays is Sn-3.0Ag-0.5Cu.
- All signal and power relays also comply with RoHS. Please refer to individual data sheets. Relays that are RoHS compliant do not contain the 5 hazardous materials that are restricted by RoHS directive (lead, mercury, chromium IV, PBB, PBDE).
- It has been verified that using lead-free relays in leaded assembly process will not cause any problems (compatible).
- "LF" is marked on each outer and inner carton. (No marking on individual relays).
- To avoid leaded relays (for lead-free sample, etc.) please consult with area sales office.
- We will ship leaded relays as long as the leaded relay inventory exists.

Note: Cadmium was exempted from RoHS on October 21, 2005. (Amendment to Directive 2002/95/EC)

2. Recommended Lead Free Solder Profile

- Recommended solder paste Sn-3.0Ag-0.5Cu.

Reflow Solder condition

Flow Solder condition:

Pre-heating: maximum 120°C
Soldering: dip within 5 sec. at
260°C solder bath

Solder by Soldering Iron:

Soldering Iron
Temperature: maximum 360°C
Duration: maximum 3 sec.

We highly recommend that you confirm your actual solder conditions

3. Moisture Sensitivity

- Moisture Sensitivity Level standard is not applicable to electromechanical relays.

4. Tin Whisker

- Dipped SnAgCu solder is known as low risk tin whisker. No considerable length whisker was found by our in house test.

Fujitsu Components International Headquarter Offices

Japan

Fujitsu Component Limited
Gotanda-Chuo Building
3-5, Higashigotanda 2-chome, Shinagawa-ku
Tokyo 141, Japan
Tel: (81-3) 5449-7010
Fax: (81-3) 5449-2626
Email: promothq@ft.ed.fujitsu.com
Web: www.fcl.fujitsu.com

North and South America

Fujitsu Components America, Inc.
250 E. Caribbean Drive
Sunnyvale, CA 94089 U.S.A.
Tel: (1-408) 745-4900
Fax: (1-408) 745-4970
Email: components@us.fujitsu.com
Web: <http://www.fujitsu.com/us/services/edevices/components/>

Europe

Fujitsu Components Europe B.V.
Diamantlaan 25
2132 WV Hoofddorp
Netherlands
Tel: (31-23) 5560910
Fax: (31-23) 5560950
Email: info@fceu.fujitsu.com
Web: emea.fujitsu.com/components/

Asia Pacific

Fujitsu Components Asia Ltd.
102E Pasir Panjang Road
#01-01 Citilink Warehouse Complex
Singapore 118529
Tel: (65) 6375-8560
Fax: (65) 6273-3021
Email: fcalfcal.fujitsu.com
Web: <http://www.fujitsu.com/sg/services/micro/components/>

©2008 Fujitsu Components America, Inc. All rights reserved. All trademarks or registered trademarks are the property of their respective owners.

Fujitsu Components America or its affiliates do not warrant that the content of datasheet is error free. In a continuing effort to improve our products Fujitsu Components America, Inc. or its affiliates reserve the right to change specifications/datasheets without prior notice.
Rev. October 20, 2008.