

FERROXCUBE

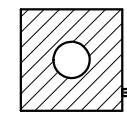

e

f

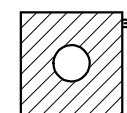
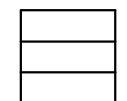

1 2 3 4 5 6 7 8

a
b
c
d
e
f

a
b
c
d

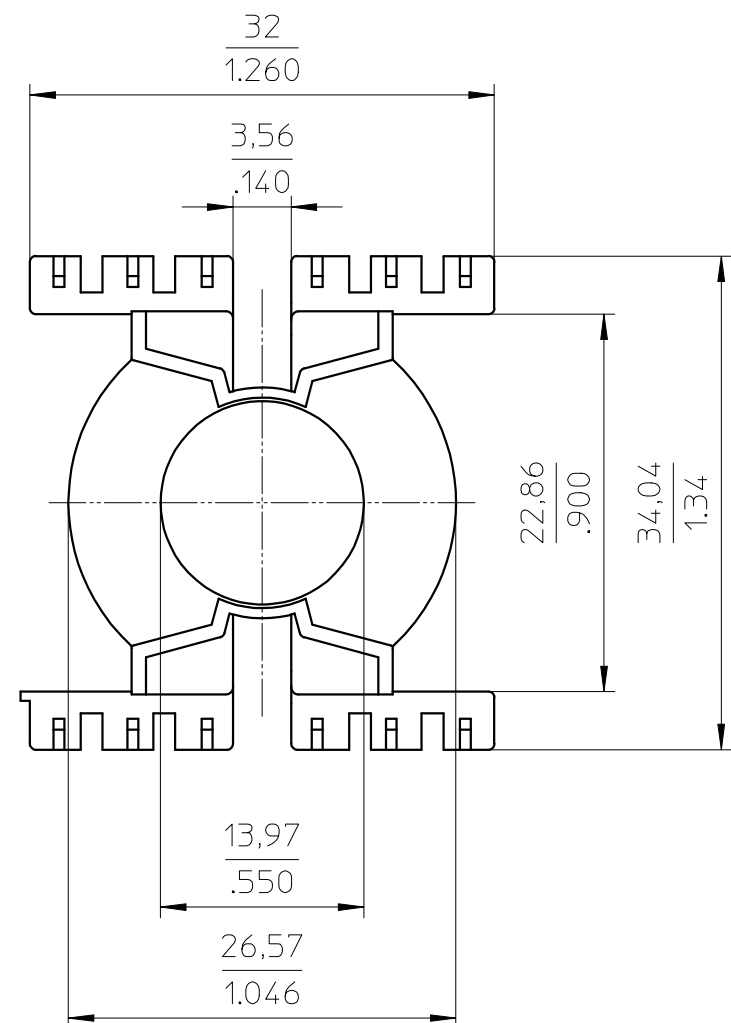
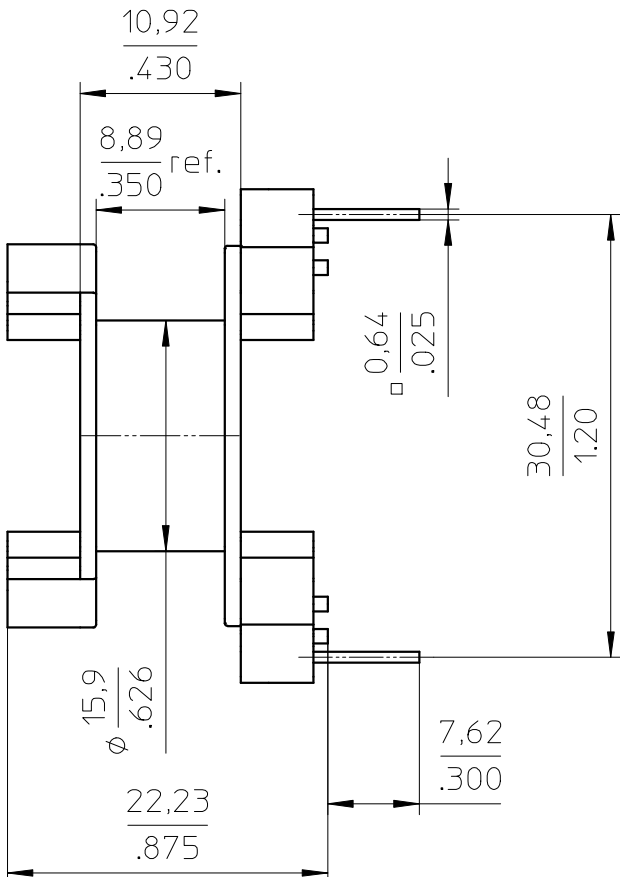
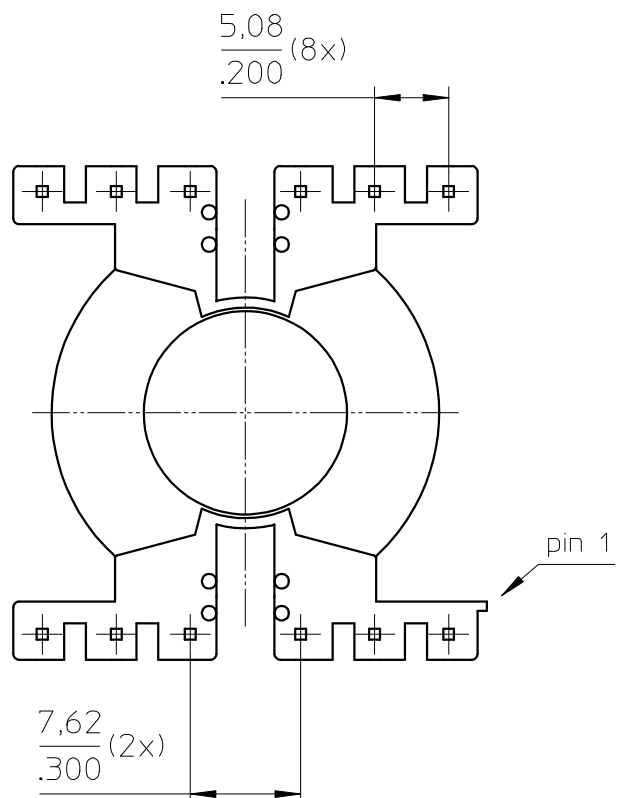

Grid pattern

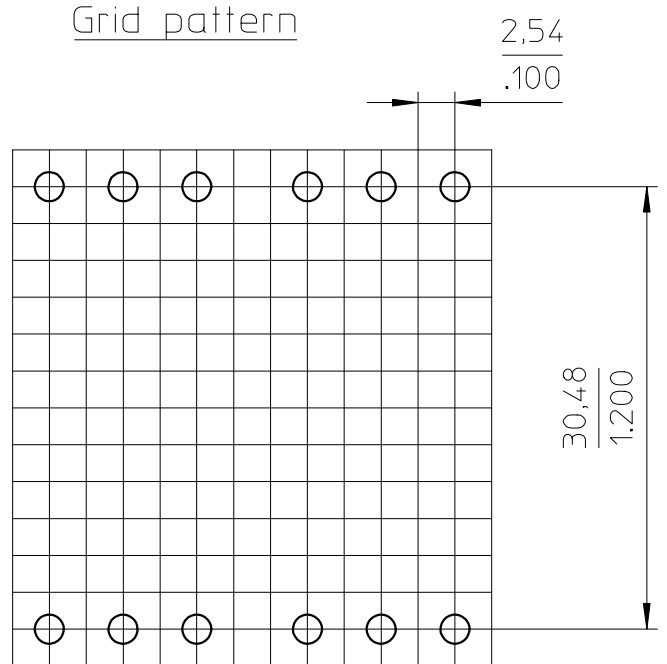

Coil former material: Rynite FR530 (PET), glass-reinforced, (color black).
 UL file number: E41938 - UL94V-0.
 max. operating temp: 180°C, class H
 pin material: Copper-plated steel wire, Sn plated.
 solderability: acc. to IEC 60068-2-20 part2, Test Ta method 1, 235C-2sec.
 mean length of turn: 2.626 inch
 winding area: 0.074 sq. inch.

CLASS.NO.	CPV-PQ32/20-1S-12P-Z		4335 060 26791	06-02-22
NAME NAAM	A.Wojtasz	SUPERS. VERV.	-	A3
MPA	CHECK CONTR.	DAT.	06-02-22	Property of Eigendom van © FERROXCUBE 2000