

**FERROXCUBE**

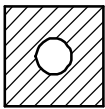
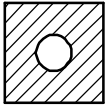

1 2 3 4

a

b

c

d

a

b

c

d

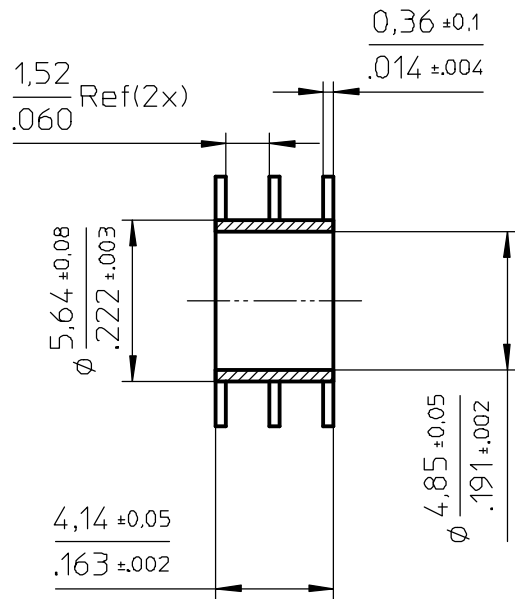
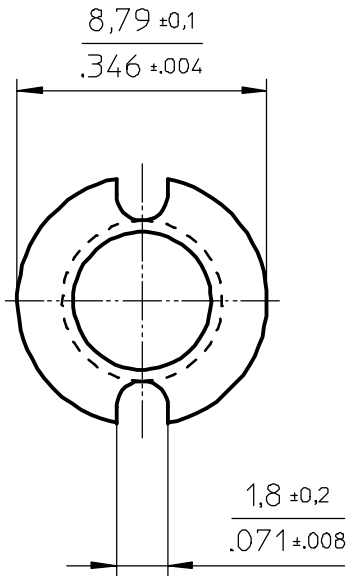

Coil former material: Delrin 900 (POM).  
 UL file number: E66288 - UL94HB.  
 Max. operating temp: 130°C  
 mean length of turn: 0.892 inch  
 winding area: 0.0031 sq inch

		CP-P11/7-2S-A		4335 000 26021		01-06-01
						02-11-04
NAME NAAM	JON	SUPERS. VERV	1	SH BL	SH BL	112 - 001
MPA	CHECK CONTR.	DAT.	Property of Eigendom van		© FERROXCUBE 2002	

**A4**